

Index

COSABELLA®

PRODUCTS.



SD-22

Sliding System
Sürme Sistem



SD-23

Sliding System
Sürme Sistem



SD-32

Sliding System
Sürme Sistem



SD-33

Sliding System
Sürme Sistem



SD-35

Sliding System
Sürme Sistem



FS-72

Facade System
Cephe Sistemi



WD-42

Opening System
Açılır Sistem









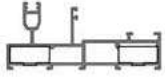

WD-52

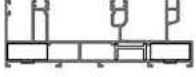
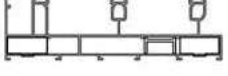
Opening System
Açılır Sistem

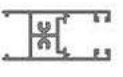
SD22
SD23
SD32
SD33
SD35
WD42
WD52
FS72

SD22

Profil Profile	Profil Kodu Profile Nr	Ağırlık (kg/m.) Weight (kg/m.)	X mm.	Y mm.	Jx cm ⁴	Jy cm
	7136 Tekli Kasa Profili Frame Profile	1,341kg/mt	99,7 mm	43,5 mm	45,92	6,20
	7137 Sürme Kasa Profili Frame Profile	1,396kg/mt	90,2 mm	43,5 mm	43,50	8,67
	7138 Sineklikli Kasa Profili Frame Profile	1,837kg/mt	122,1 mm	43,5 mm	100,18	11,50
	7139 Üçlü Kasa Profili Frame Profile	2,021kg/mt	141,4 mm	43,24 mm	148,27	12,68
	7140 Yatay Kanat Pr. Sash Pr.	1,113kg/mt	75 mm	29 mm	15,55	5,02
	7141 Kilit Kanat Profili Sash Profile	1,133kg/mt	70 mm	32 mm	13,57	5,96
	7142 45° Kanat Profili Sash Profile	0,927kg/mt	71 mm	32 mm	13,56	6,00
	7181 Adaptör Profili Adapter Profile	0,616 kg/m	40,53 mm	47,7 mm	5,70	1,75
	7144 Takviyeli Kenet Kanat Profili Sash Profile	1,008kg/mt	82,7 mm	20 mm	28,15	1,45
	7143 Kenet Kanat Pr. Sash Pr.	0,532kg/mt	47,7 mm	20 mm	4,89	0,60

Profil Profile	Profil Kodu Profile Nr	Ağırlık (kg/m.) Weight (kg/m.)	X mm.	Y mm.	Jx cm ⁴	Jy cm ⁴
	7145 Kenet Kanat Pr. Sash Pr.	0,599kg/mt	39,74 mm	29 mm	4,25	1,36
	7146 Orta Kayıt Profili Middle Transom Profile	0,866kg/mt	65,94 mm	29 mm	13,17	1,13
	7179 Kilitleme Profili Adapter Profile	0,730kg/mt	35,27 mm	39,53 mm	4,38	2,07
	6875 Cam Çıta Profili Glazing Bread Pr.	0,271 kg/m	29 mm	19,86 mm	-	-
	6783 Adaptör Profili Adapter Profile	0,514 kg/m	64,2 mm	23,6 mm	-	-
	6782 Adaptör Profili Adapter Profile	0,446 kg/m	23,57 mm	64,2 mm	-	-
	7106 Sineklik Profili Fly Screen Profile	0,521 kg/m	31,8 mm	43,5 mm	-	-
	7020 Sineklik Profili Fly Screen Profile	0,532 kg/m	33,15 mm	35 mm	-	-
	6912 H Destek Profili H Support Profile	0,148 kg/m	19,33 mm	9,88 mm	-	-

Sürme Tekli Kasa Profili - Sliding Frame Profile

7136

1,341 kg/mt

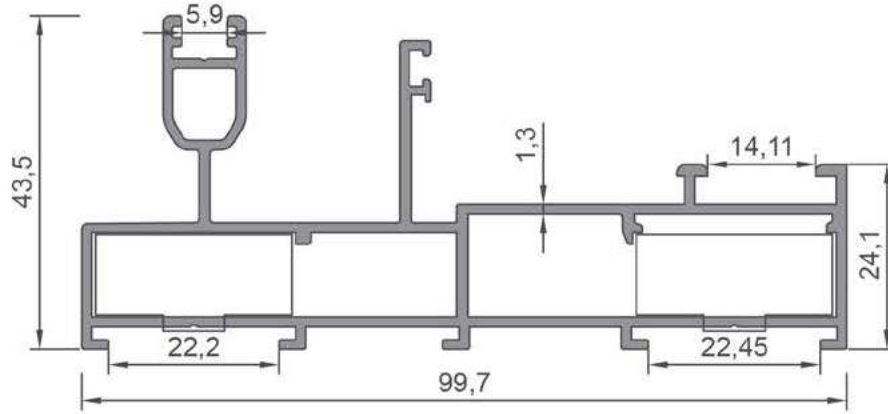

7136

Kod/Code	Et Kalın./Wall Thk.	Ürün Adı / Prod. Name	Ağırlığı / Weight	Köşe Takozu / C. Cleat
7136	1,3 mm	Tekli Kasa Pr. / Sliding Frame Profile	1,341 kg/mt	-

Sürme Kasa Profili - Sliding Frame Profile

7137

1,396 kg/mt

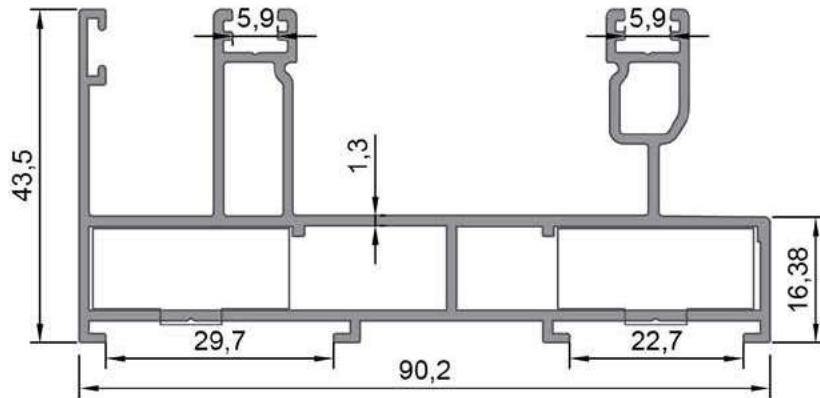

7137

Kod/Code	Et Kalın./Wall Thk.	Ürün Adı / Prod. Name	Ağırlığı /Weight	Köşe Takozu / C. Cleat
7137	1,3 mm	Sürme Kasa Pr. / Sliding Frame Pr.	1,396 kg/mt	-

Sineklikli Kasa Profili - Sliding Frame Profile

7138

1,837 kg/mt

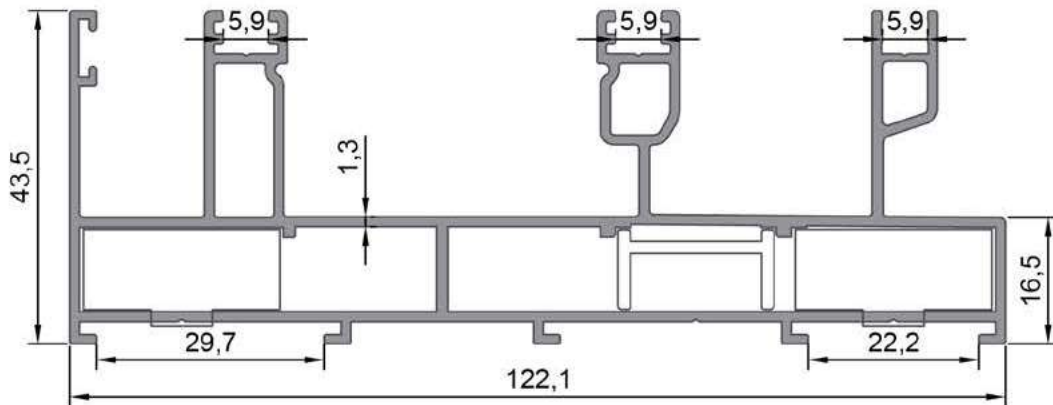

7138

Kod/Code	Et Kalın./Wall Thk.	Ürün Adı / Prod. Name	Ağırlığı /Weight	Köşe Takozu / C. Cleat
7138	1,3 mm	Sineklikli Kasa Pr./Fly Screen Frame Pr.	1,837 kg/mt	-

Üçlü Sürme Kasa Profili - Sliding Frame Profile

7139

2,021 kg/mt

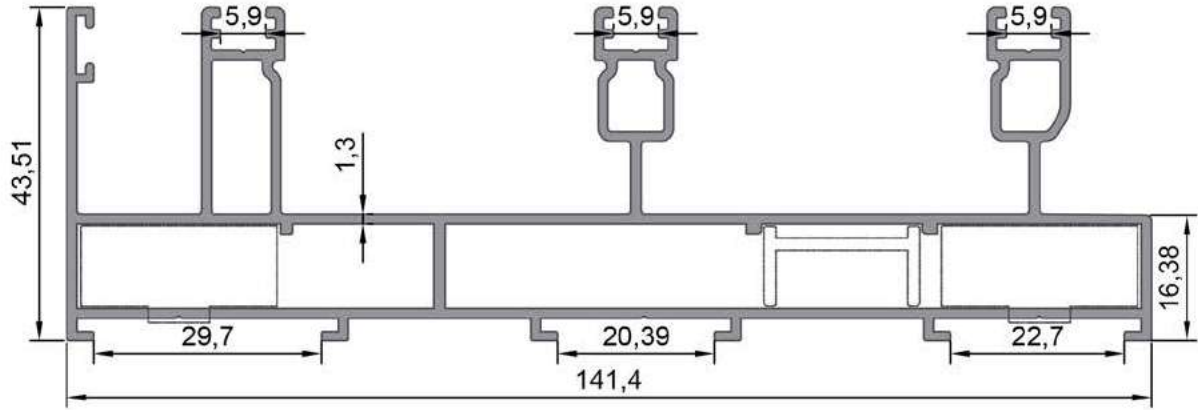

7139

Kod/Code	Et Kalın./Wall Thk.	Ürün Adı / Prod. Name	Ağırlığı / Weight	Köşe Takozu / C. Cleat
7139	1,3 mm	Üçlü Kasa Pr. / Sliding Frame Profile	2,021 kg/mt	-

Yatay Kanat Profili - Horizontal Sash Profile

7140

1,113 kg/mt

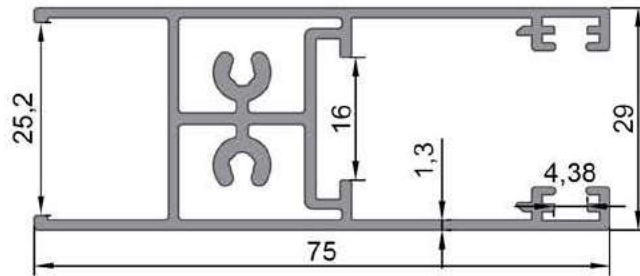

7140

Kod/Code	Et Kalın./Wall Thk.	Ürün Adı / Prod. Name	Ağırlığı / Weight	Köşe Takozu / C. Cleat
7140	1,3 mm	Yatay Kanat Pr. / Horizontal Sash Pr.	1,113 kg/mt	-

90° Kilit Kanat Profili - Sash Profile

7141

1,133 kg/mt

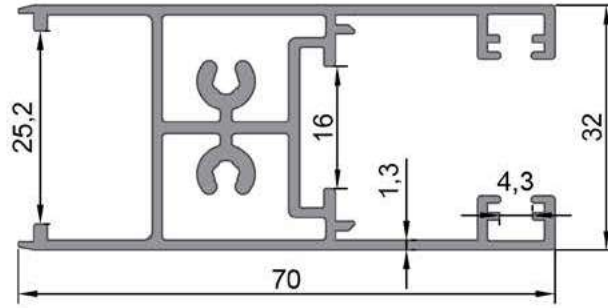

7141

Kod/Code	Et Kalın./Wall Thk.	Ürün Adı / Prod. Name	Ağırlığı / Weight	Köşe Takoğu / C. Cleat
7141	1,3 mm	Kilit Kanat Pr. / Locking Sash Profile	1,133 kg/mt	-

Adaptör Profili - Adapter Profile

7181

0,616 kg/mt

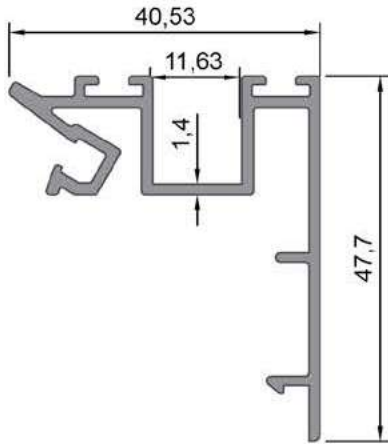

7181

45° Kanat Profili - Sash Profile

7142

0,927 kg/mt

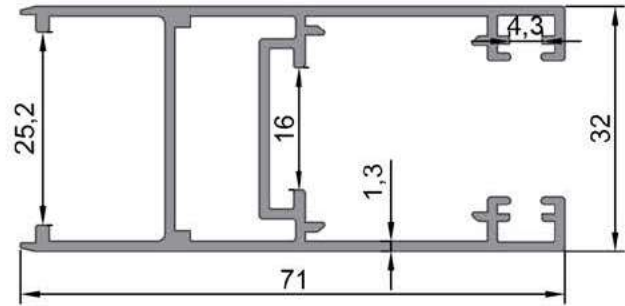

7142

Kod/Code	Et Kalın./Wall Thk.	Ürün Adı / Prod. Name	Ağırlığı / Weight	Köşe Takoğu / C. Cleat
7181	1,4 mm	Adaptör Pr. / Adapter Profile	0,616 kg/mt	-
7142	1,3 mm	45° Kanat Pr. / 45° Sash Profile	0,927 kg/mt	-

Takviyeli Kenet Kanat Profili - Sash Profile
7144
1,008 kg/mt

Takviyesiz Kenet Kanat Profili - Sash Profile
7143
0,532 kg/mt

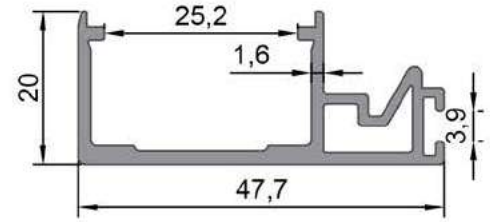
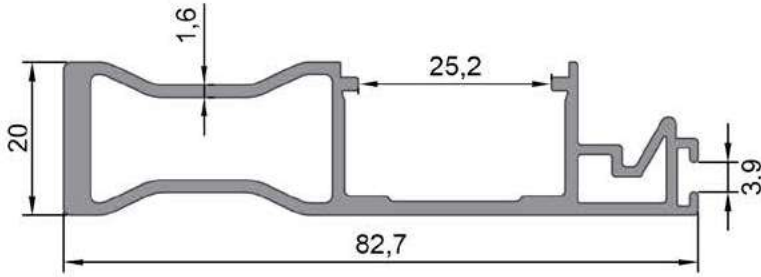

7144

7143

Kod/Code	Et Kalın./Wall Thk.	Ürün Adı / Prod. Name	Ağırlığı / Weight	Köşe Takozu / C. Cleat
7144	1,6 mm	Takviyeli Kanat / Reinforced Sash Pr.	1,008 kg/mt	-
7143	1,6 mm	Takviyesiz Kanat / Non-Reinforced Sash Pr.	0,532 kg/mt	-

Kenet Kanat Profili - Sash Profili
7145
0,599 kg/mt

Tekli Kasa Orta Kayıt Profili - Middle Transom Profile
7146
0,866 kg/mt

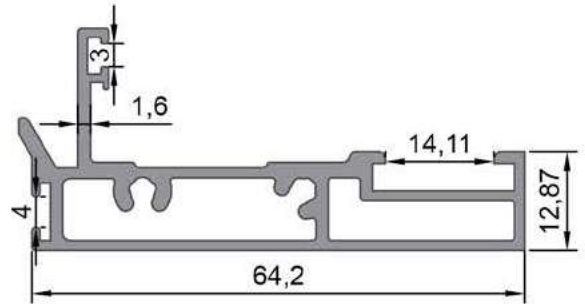
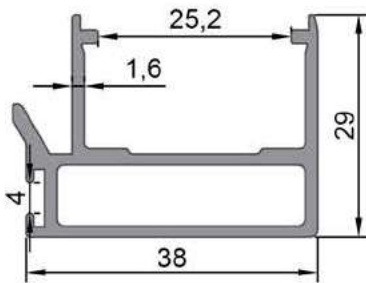

7145

7146

Kod/Code	Et Kalın./Wall Thk.	Ürün Adı / Prod. Name	Ağırlığı / Weight	Köşe Takozu / C. Cleat
7145	1,6 mm	Kenet Kanat Pr. / Interlock Sash Profile	0,599 kg/mt	-
7146	1,6 mm	Orta Kayıt Pr. / Middle Transom Profile	0,866 kg/mt	-

Sineklik Kasa Profili-Fly Screen Frame Profile

7106

0,522 kg/mt

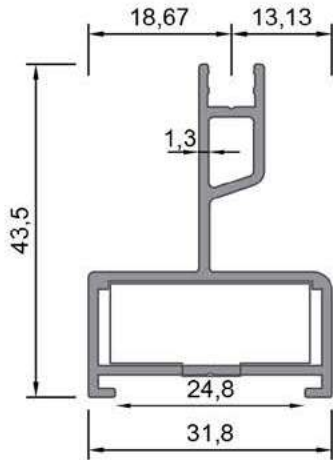

7106

Sineklik Profili - Fly Screen Profile

7020

0,532 kg/mt

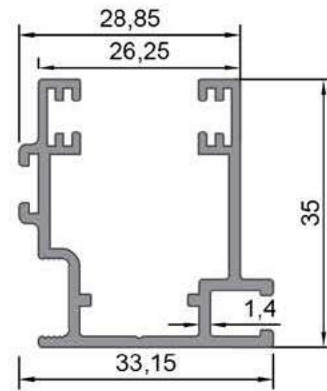

7020

Kod/Code	Et Kalın./Wall Thk.	Ürün Adı / Prod. Name	Ağırlığı /Weight	Köşe Takozu / C. Cleat
7106	1,3 mm	Tekli Sineklik Pr. / Fly Screen Frame Pr.	0,522 kg/mt	-
7020	1,4 mm	Sineklik Pr. / Fly Screen Profile	0,532 kg/mt	-

H Destek Profili- H Support Profile

6912

0,148 kg/mt

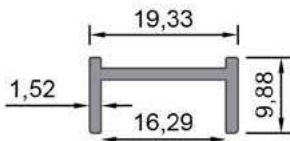

6912

Kod/Code	Et Kalın./Wall Thk.	Ürün Adı / Prod. Name	Ağırlığı /Weight	Köşe Takozu / C. Cleat
6912	1,52mm	H Destek Pr. / H Support Profile	0,148 kg/mt	-

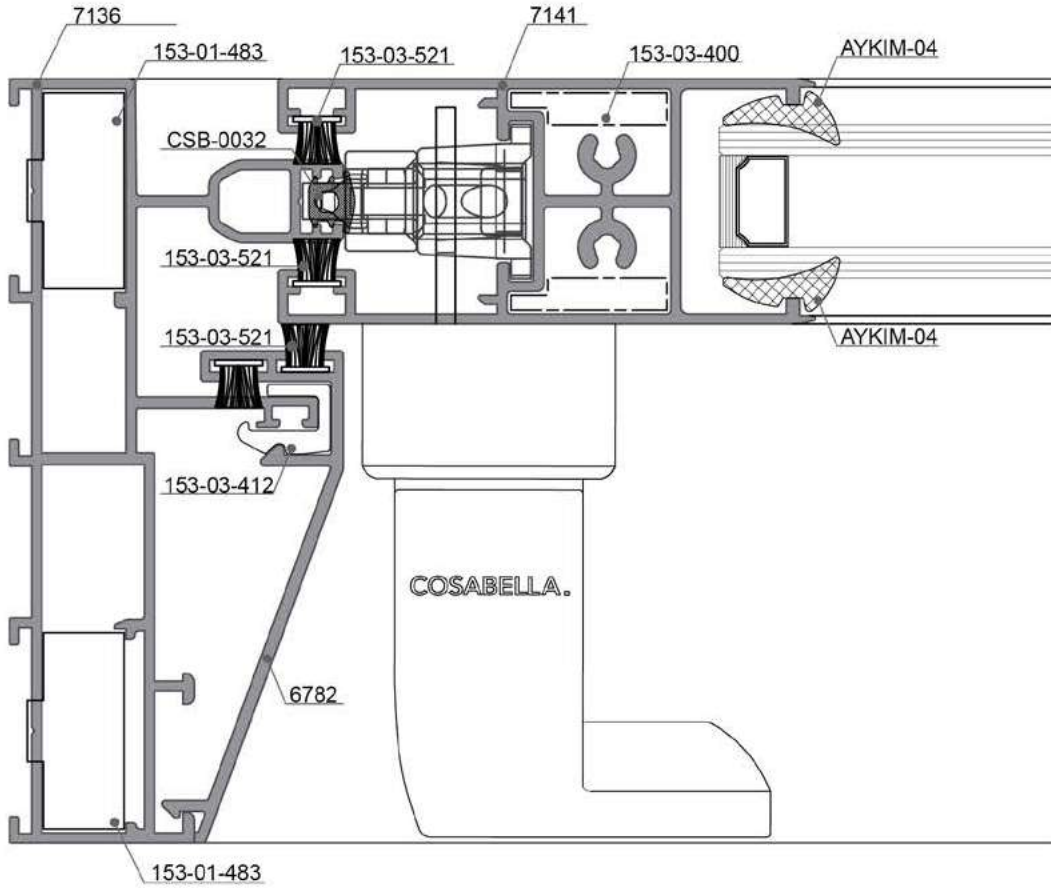
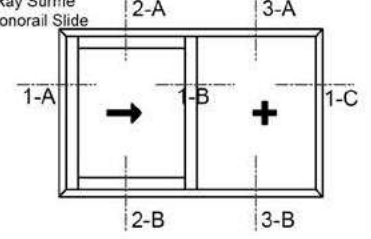
90° Klasik Tek Ray Sürme
90° Classical Monorail Slide1-A DETAYI
DETAIL

Ölçek: 1:1 / Scale: 1:1

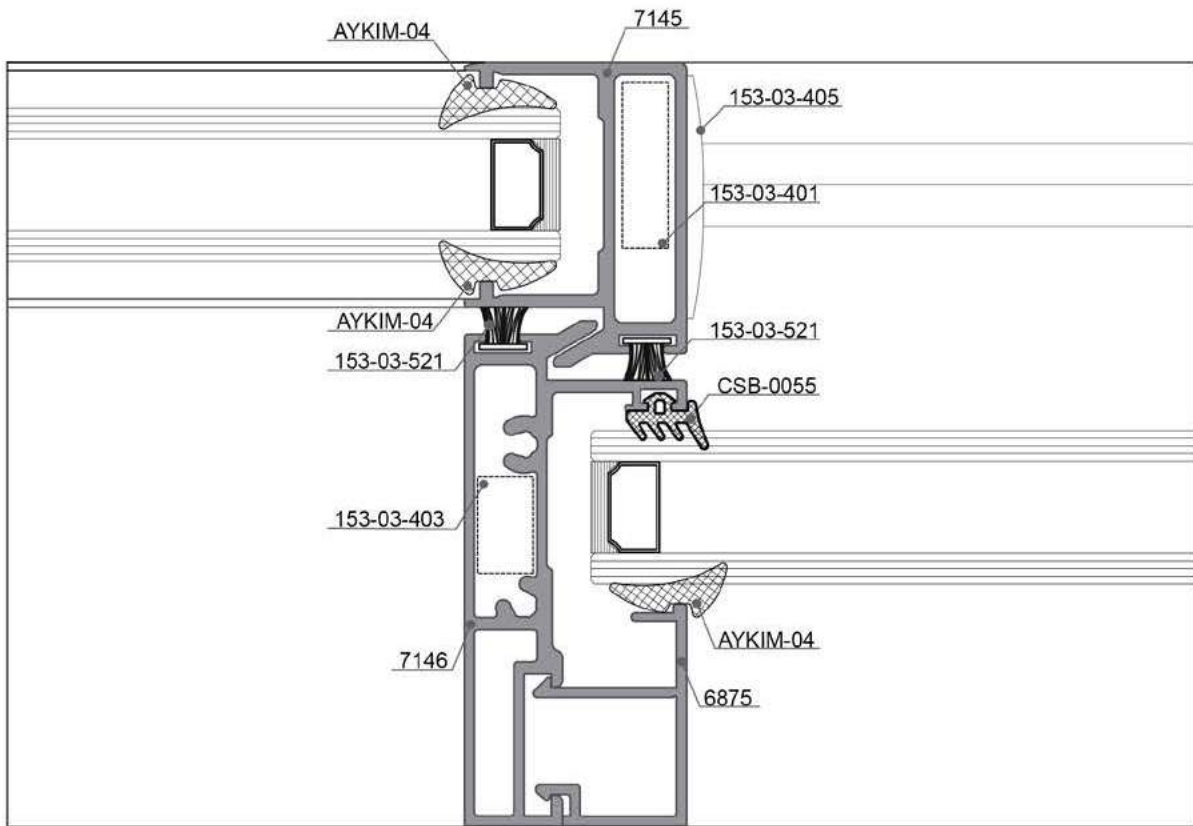
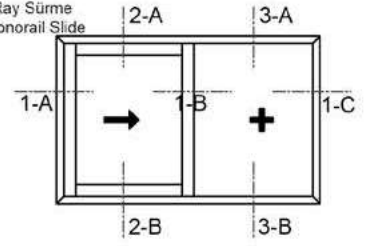
90° Klasik Tek Ray Sürme
 90° Classical Monorail Slide

 1-B DETAYI
 DETAIL

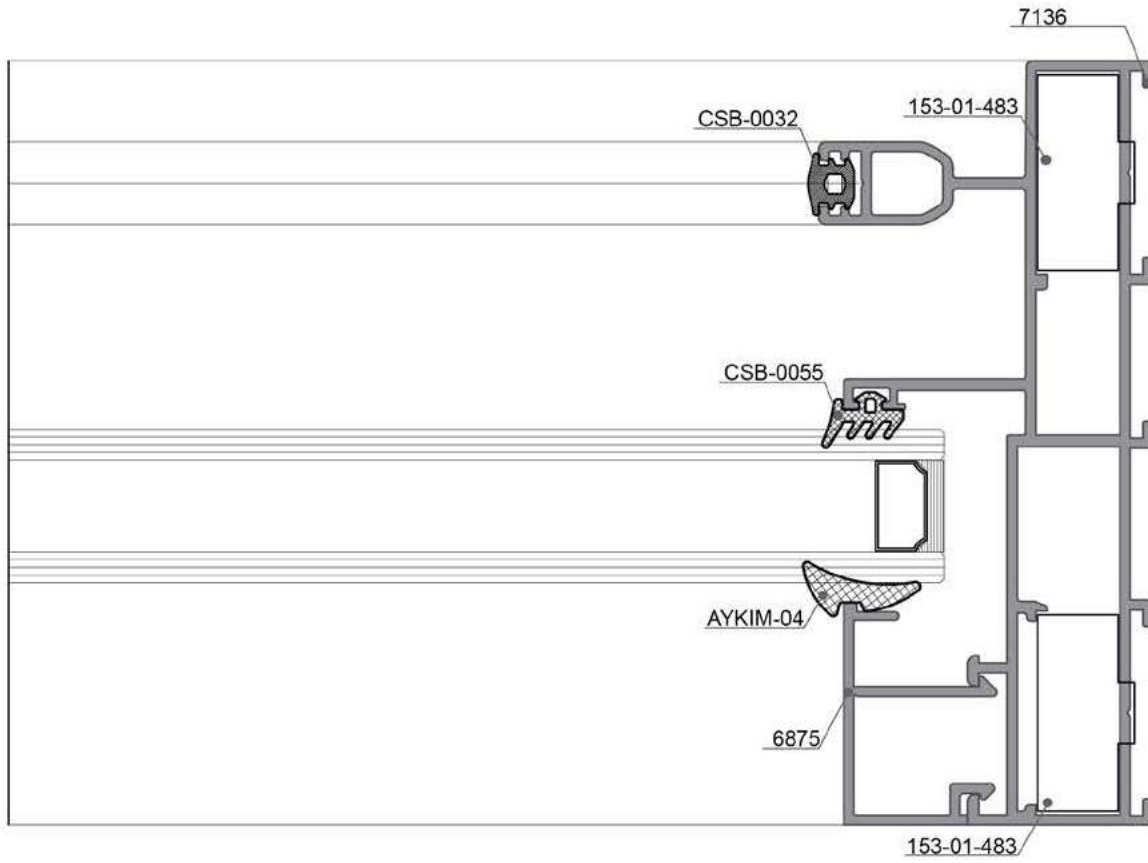
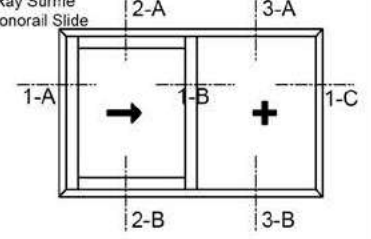
Ölçek: 1:1 / Scale: 1:1

90° Klasik Tek Ray Sürme
90° Classical Monorail Slide1-C DETAYI
DETAIL

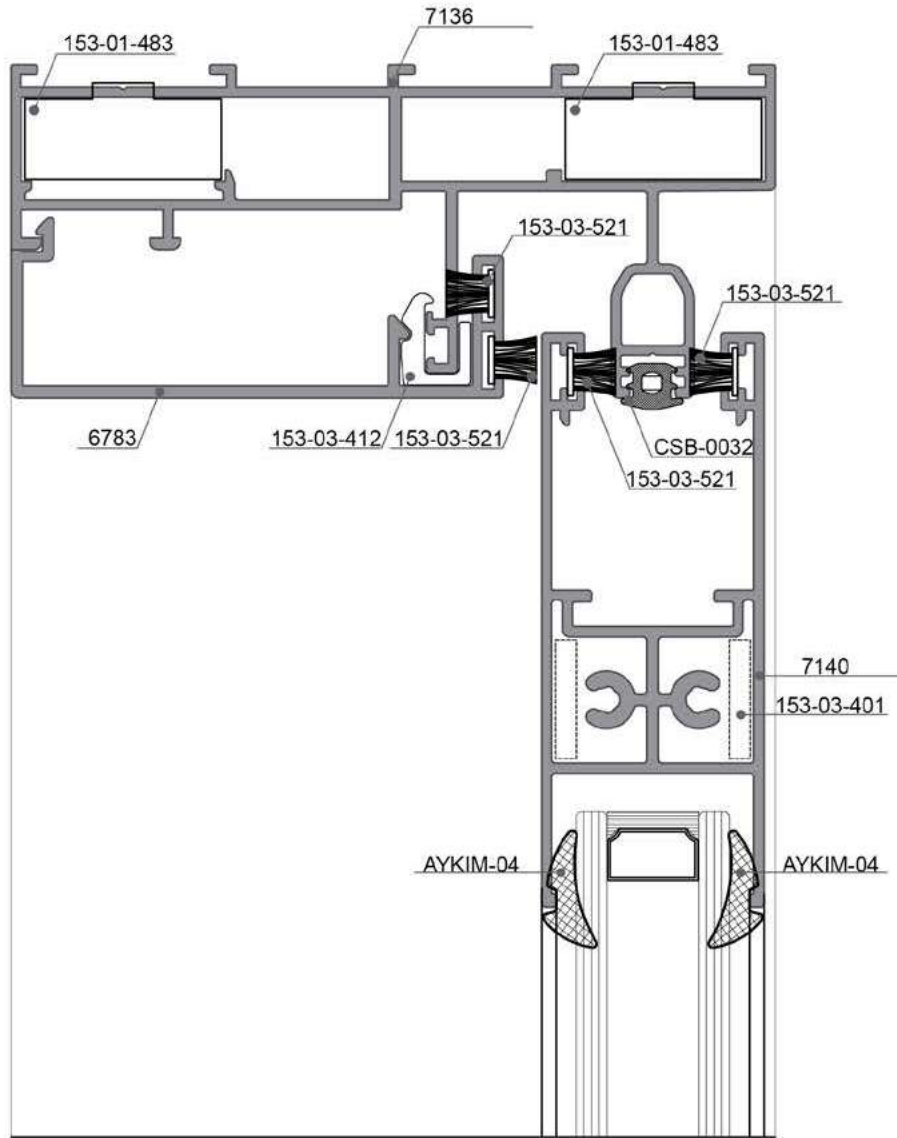
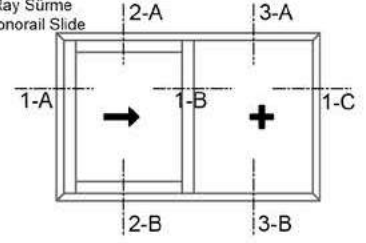
Ölçek: 1:1 / Scale: 1:1

90° Klasik Tek Ray Süre
 90° Classical Monorail Slide

 2-A DETAYI
 DETAIL

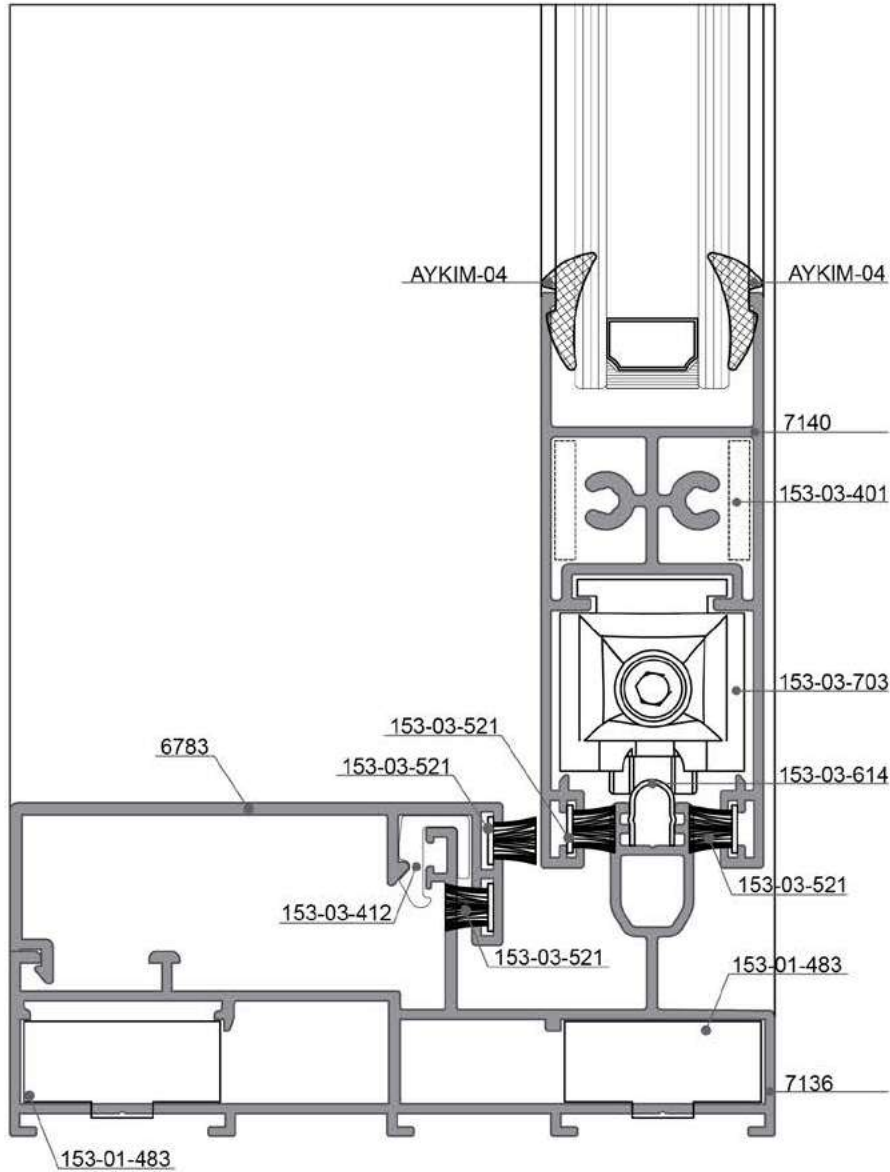
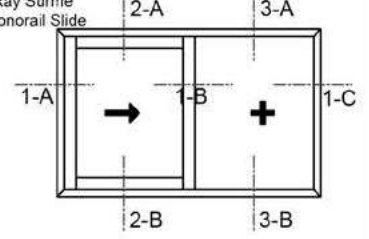
Ölçek: 1:1 / Scale: 1:1

90° Klasik Tek Ray Sürme
90° Classical Monorail Slide2-B DETAYI
DETAIL

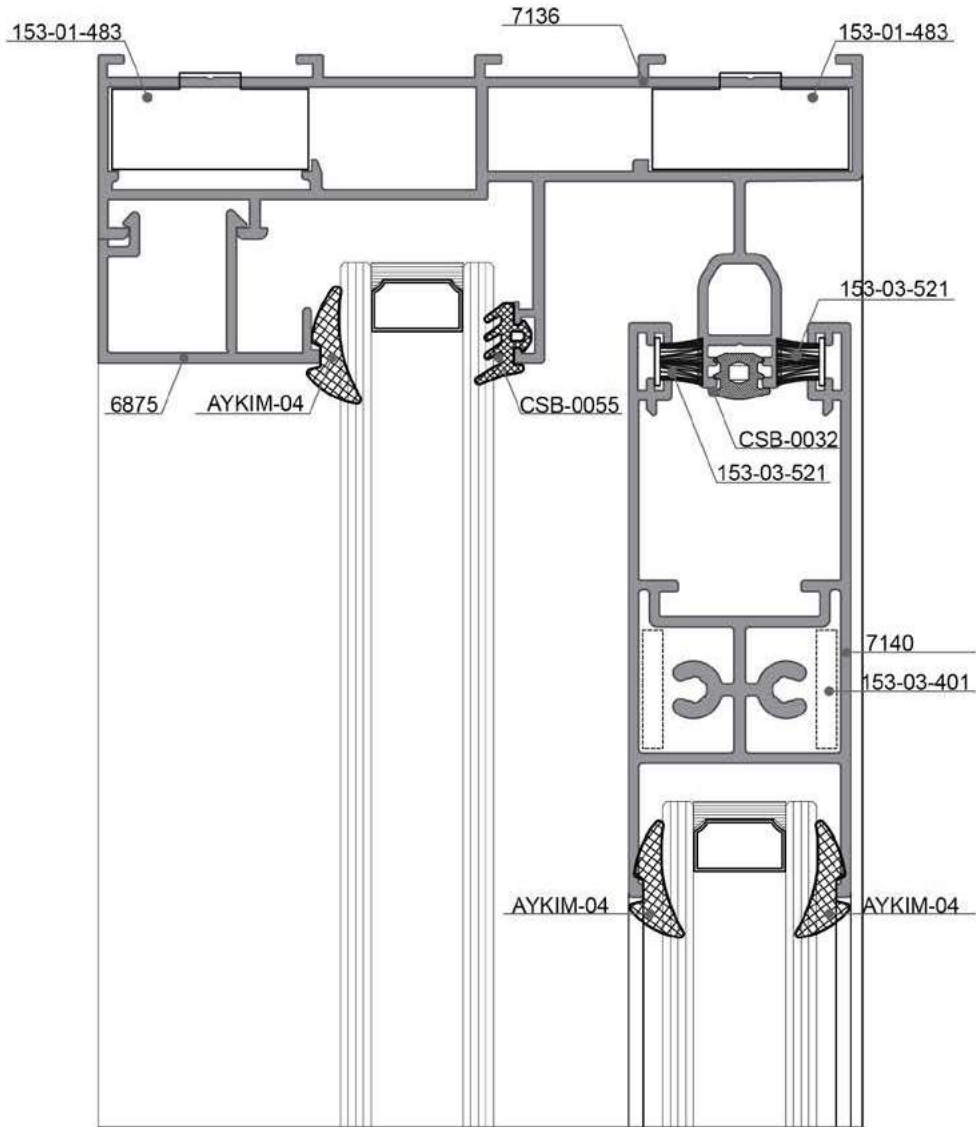
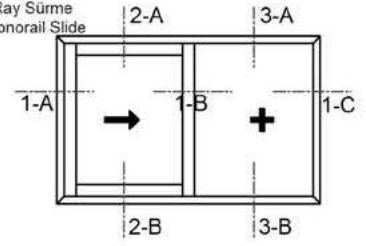
Ölçek: 1:1 / Scale: 1:1

90° Klasik Tek Ray Sürme
 90° Classical Monorail Slide

 3-A DETAYI
 DETAIL

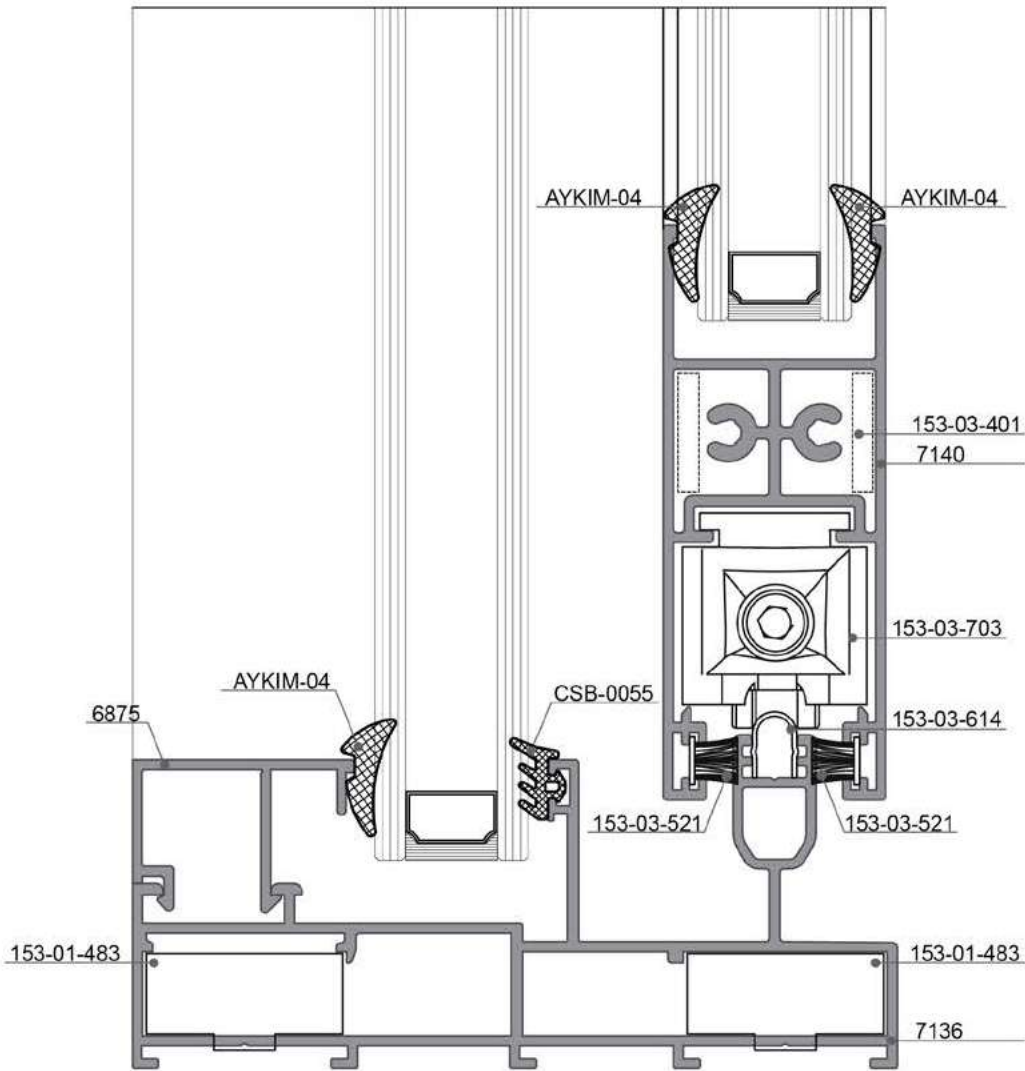
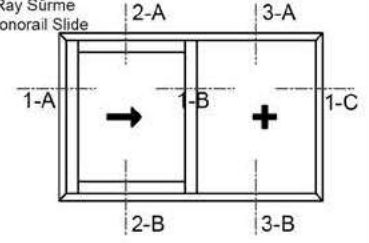
Ölçek: 1:1 / Scale: 1:1

90° Klasik Tek Ray Sürme
90° Classical Monorail Slide3-B DETAYI
DETAIL

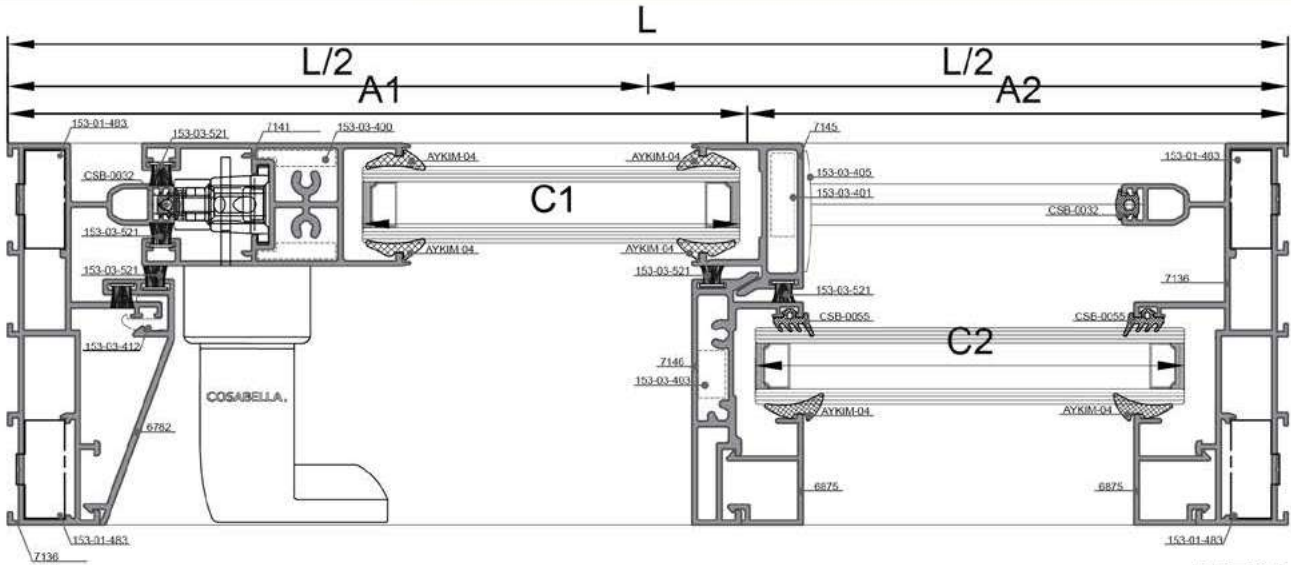
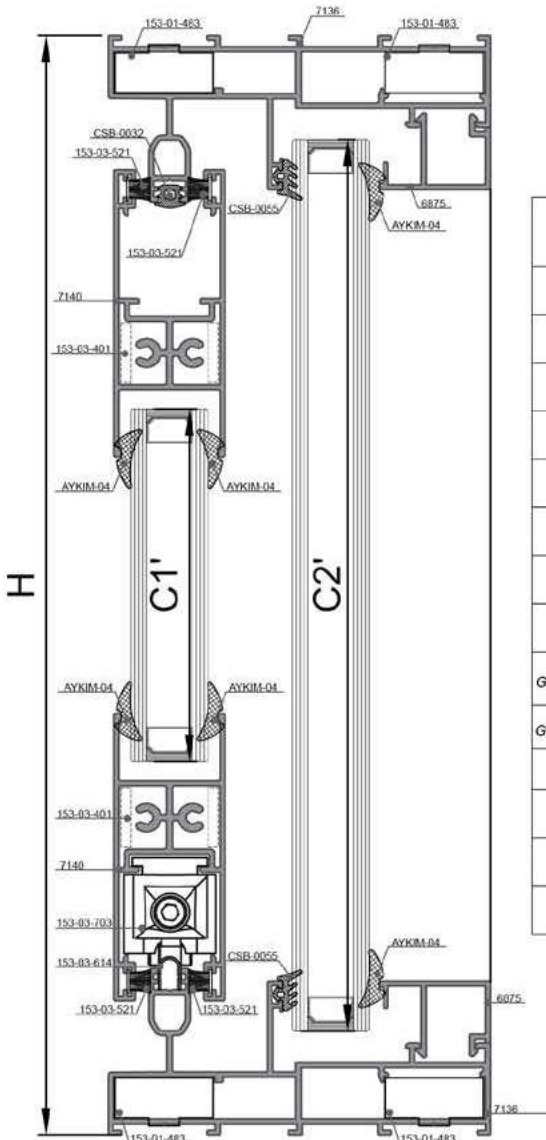
Ölçek: 1:1 / Scale: 1:1

1-1 DETAYI
DETAIL2-2 DETAYI
DETAIL





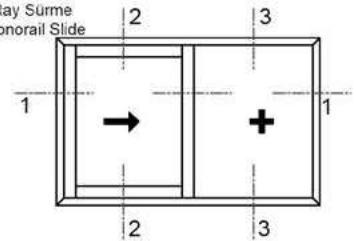



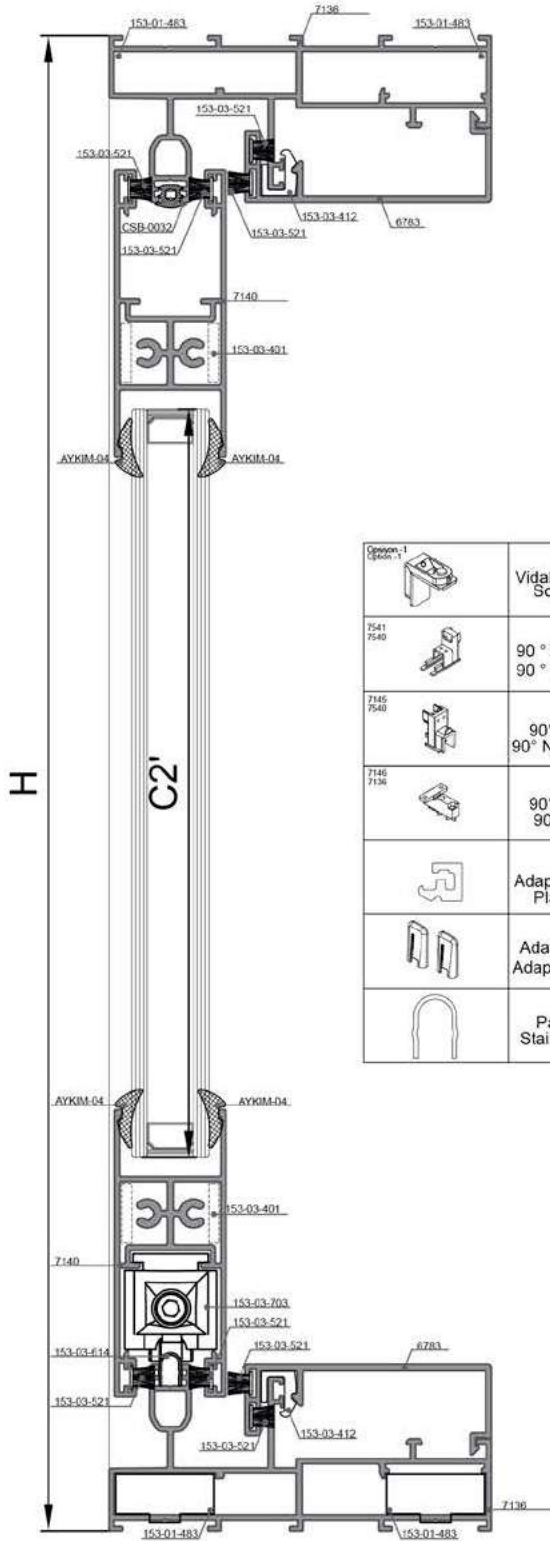



Kesim ölçüsü - cam ölçüsü vb. sorumluluğu tarafımıza ait değildir.

Kasa Genişlik Frame Width	7136			2 Ad. 2 Pcs.	L
Kasa Yükseklik Frame Height	7136			2 Ad. 2 Pcs.	H
Kanat Yükseklik Sash Height	7141			1 Ad. 1 Pcs.	H-76
Yatay Kanat Genişlik Horizontal Sash Width	7140			2 Ad. 2 Pcs.	A1-115,5
Kenet Kanat Yükseklik Sash Height	7145			1 Ad. 1 Pcs.	H-76
Orta Kayıt Yükseklik Middle Transon Height	7146			1 Ad. 1 Pcs.	H-80,46
Adaptör Profili Yükseklik Adapter Profile Height	6782			1 Ad. 1 Pcs.	H-87
Adaptör Profili Genişlik Adapter Profile Width	6783			2 Ad. 2 Pcs.	A1-38,6
Çita Profil Genişlik Glazing Bead Profile Width	6875			2 Ad. 2 Pcs.	A2-22,47
Çita Profil Yükseklik Glazing Bead Profile Height	6875			2 Ad. 2 Pcs.	H-80,46
Kanat Cam Genişlik Glazing Sash Width				1 Ad. 1 Pcs.	C1=A1-94,51
Kanat Cam Yükseklik Glazing Sash Height				1 Ad. 1 Pcs.	C1'=H-195
Sabit Cam Genişlik Fixed Glazing Width				1 Ad. 1 Pcs.	C2=A2-29
Sabit Cam Yükseklik Fixed Glazing Height				1 Ad. 1 Pcs.	C2'=H-54

90° Klasik Tek Ray Sürme
90° Classical Monorail Slide

Çizimler 1/2 Ölçeklidir.



	153-01-483 Vidalı Köşe Bağ. Takozu Screwed Corner Cleat	8 Ad. 8 Pcs.		153-03-703 Ayarlı Rulman Adjustable Roller	2 Ad. 2 Pcs.
	153-03-400 90° Geniş Köşe Bağlantı 90° Wide Sash Cor.Joint	2 Ad. 2 Pcs.		153-03-404 Kasa Alt & Üst Tozluk Central Top & Bottom Sealing	1 Tkm. 1 Set
	153-03-401 90° Dar Köşe Bağlantı 90° Narrow Sash Cor.Joint	2 Ad. 2 Pcs.		153-03-408 Stoplama	2 Ad. 2 Pcs.
	153-03-403 90° Orta Bağlantı 90° Center Joint	1 Tkm. 1 Set		153-03-521 67-650'lik Kumuş Fırlı Kıl Fırlı Brush Pile Seal	6H+4L
	153-03-412 Adaptör Kenetleme Klipsi Plastic Lock Clips	30cm ara ile kullanılacak.		CSB-0032 Ray Kapama Contası Gasket For Frame Rails	1L+2H
	153-03-405 Adaptör Kapağı Alt & Üst Adapter Cap Bottom & Top	1 Tkm. 1 Set		AYKIM-04 Glazing Wedge Gasket (Cam Terchine Göre) (Optional Glass Size)	4C1+4C1'+ 2C2+2C2'
	153-03-614 Paslanmaz Çelik Ray Stainless Steel Rail Track	L-75,8 mm. 1 Ad./Pcs.		CSB-0055 Dış Cam Contası External Glass Gasket	2C2'+2C2

3-3 DETAYI
DETAIL

Kesim ölçüsü - cam ölçüsü vb. sorumluluğu tarafımıza ait değildir.

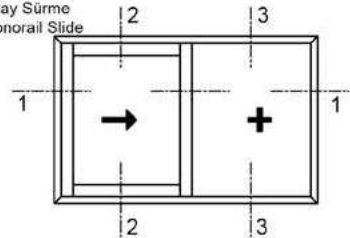
90° Klasik Tek Ray Sürme
90° Classical Monorail Slide

Çizimler 1/2 Ölçeklidir.

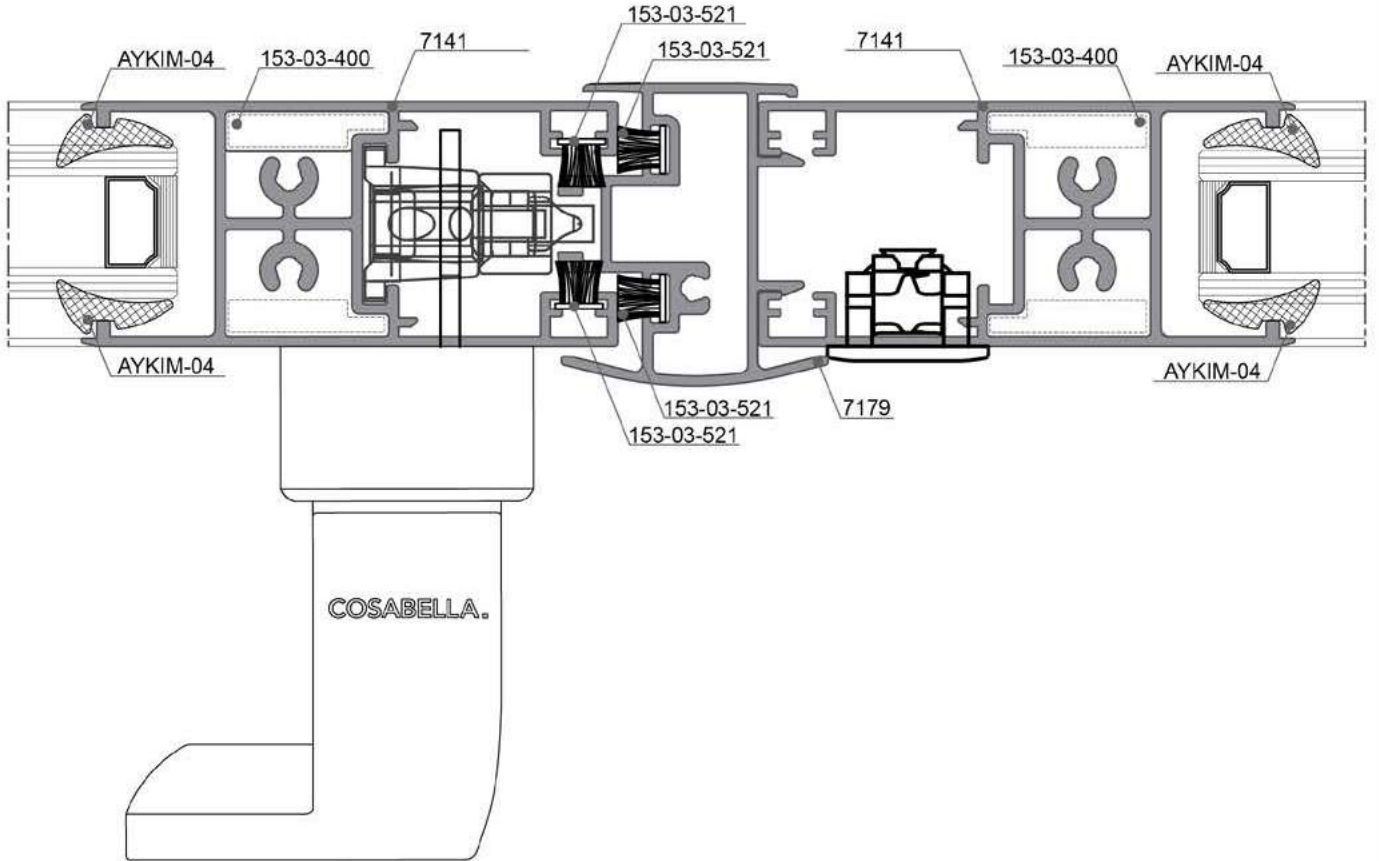
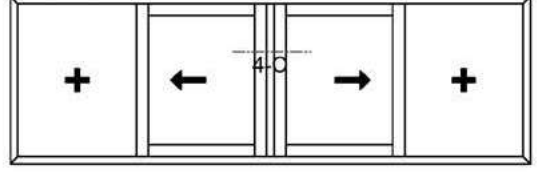
90° Klasik Tek Ray Sürme
 90° Classical Monorail Slide

 4-C DETAYI
 DETAIL

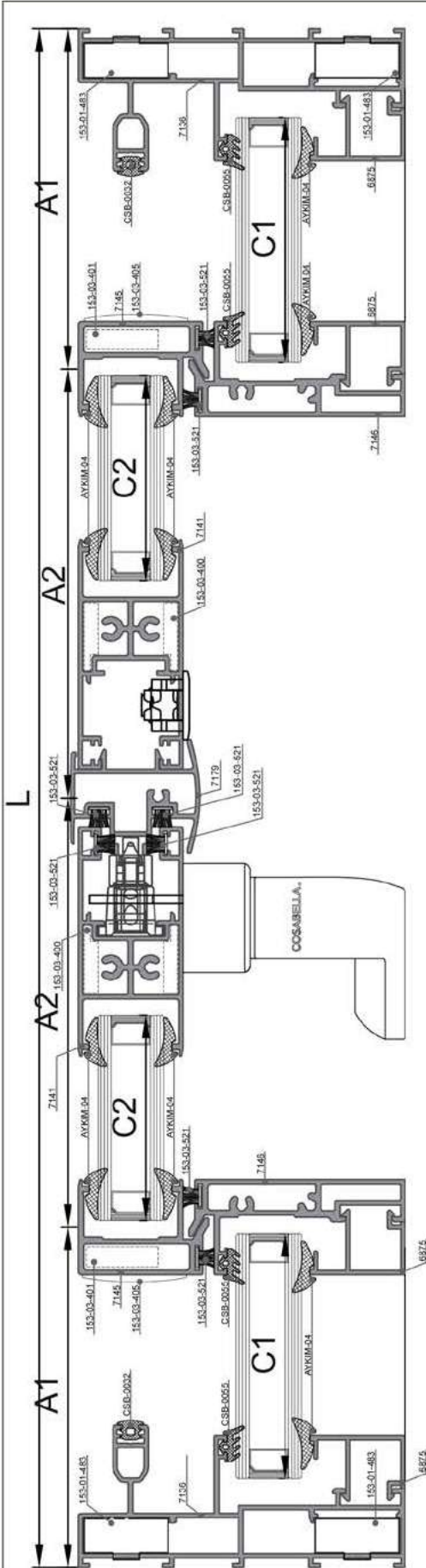
Ölçek: 1:1 / Scale: 1:1

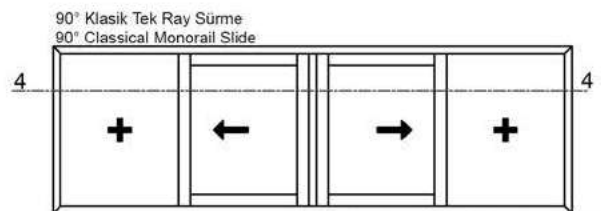

Kasa Genişlik Frame Width	7136			2 Ad. 2 Pcs.	L
Kasa Yükseklik Frame Height	7136			2 Ad. 2 Pcs.	H
Kanat Yükseklik Sash Height	7141			2 Ad. 2 Pcs.	H-76
Yatay Kanat Genişlik Horizontal Sash Width	7140			4 Ad. 4 Pcs.	A2-69,6
Kenet Kanat Yükseklik Sash Height	7145			2 Ad. 2 Pcs.	H-76
Orta Kayıt Yükseklik Middle Transom Height	7146			2 Ad. 2 Pcs.	H-80,46
Orta Adaptör Middle Adapter	7179			1 Ad. 1 Pcs.	H-106
Adaptör Profili Genişlik Adapter Profile Width	6783			2 Ad. 2 Pcs.	2A2-29
Çıta Profil Genişlik Glazing Bead Profile Width	6875			4 Ad. 4 Pcs.	A1-22,4
Çıta Profil Yükseklik Glazing Bead Profile Height	6875			4 Ad. 4 Pcs.	H-80,46
Kanat Cam Genişlik Glazing Sash Width				2 Ad. 2 Pcs.	C2=A2-68,68
Kanat Cam Yükseklik Glazing Sash Height				2 Ad. 2 Pcs.	C2'=H-195
Sabit Cam Genişlik Fixed Glazing Width				2 Ad. 2 Pcs.	C1=A1-29,1
Sabit Cam Yükseklik Fixed Glazing Height				2 Ad. 2 Pcs.	C1'=H-54,2

Opsiyon / Option	153-01-483 Vidalı Köşe Bağ. Takozu Screwed Corner Cleat	8 Ad. 8 Pcs.		153-03-703 Ayarlı Rulman Adjustable Roller	4 Ad. 4 Pcs.
7541 7540	153-03-400 90° Geniş Köşe Bağlantı 90° Wide Sash Cor.Joint	4 Ad. 4 Pcs.		153-03-404 Kasa Alt & Üst Tozluk Central Top & Bottom Sealing	2 Tkm. 2 Set
7145 7540	153-03-401 90° Dar Köşe Bağlantı 90° Narrow Sash Cor.Joint	4 Ad. 4 Pcs.		153-03-408 Stoplama Stoppage	4 Ad. 4 Pcs.
7146 7136	153-03-403 90° Orta Bağlantı 90° Center Joint	2 Tkm. 2 Set		153-03-521 67-650'lık Kumuş Fınlı Kil Fiti Brush Pile Seal	8H+4L
	153-03-412 Adaptör Kenetleme Klipsi Plastic Lock Clips	30cm ara ile kullanılacak.		CSB-0032 Ray Kapama Contası Gasket For Frame Rails	1L+2H
	153-03-405 Adaptör Kapağı Alt & Üst Adapter Cap Bottom & Top	2 Tkm. 2 Set		AYKIM-04 Glazing Wedge Gasket (Cam Terçimine Göre) (Optional Glass Size)	4C1'+4C1'+ 8C2'+8C2'
	153-03-614 Paslanmaz Çelik Ray Stainless Steel Rail Track	L-75,8 mm. 1 Ad./Pcs.		CSB-0055 Dış Cam Contası External Glass Gasket	4C1'+4C1
	153-03-407 4'lü Kanat Adaptör Kapağı Cosabella S32-T 4 Winged Lid	1 Tkm. 1 Set.			

4-4 DETAYI
DETAIL

Ölçek: 1:2 / Scale: 1:2

Kesim ölçüsü - cam ölçüsü vb. sorumluluğu tarafımıza ait değildir.

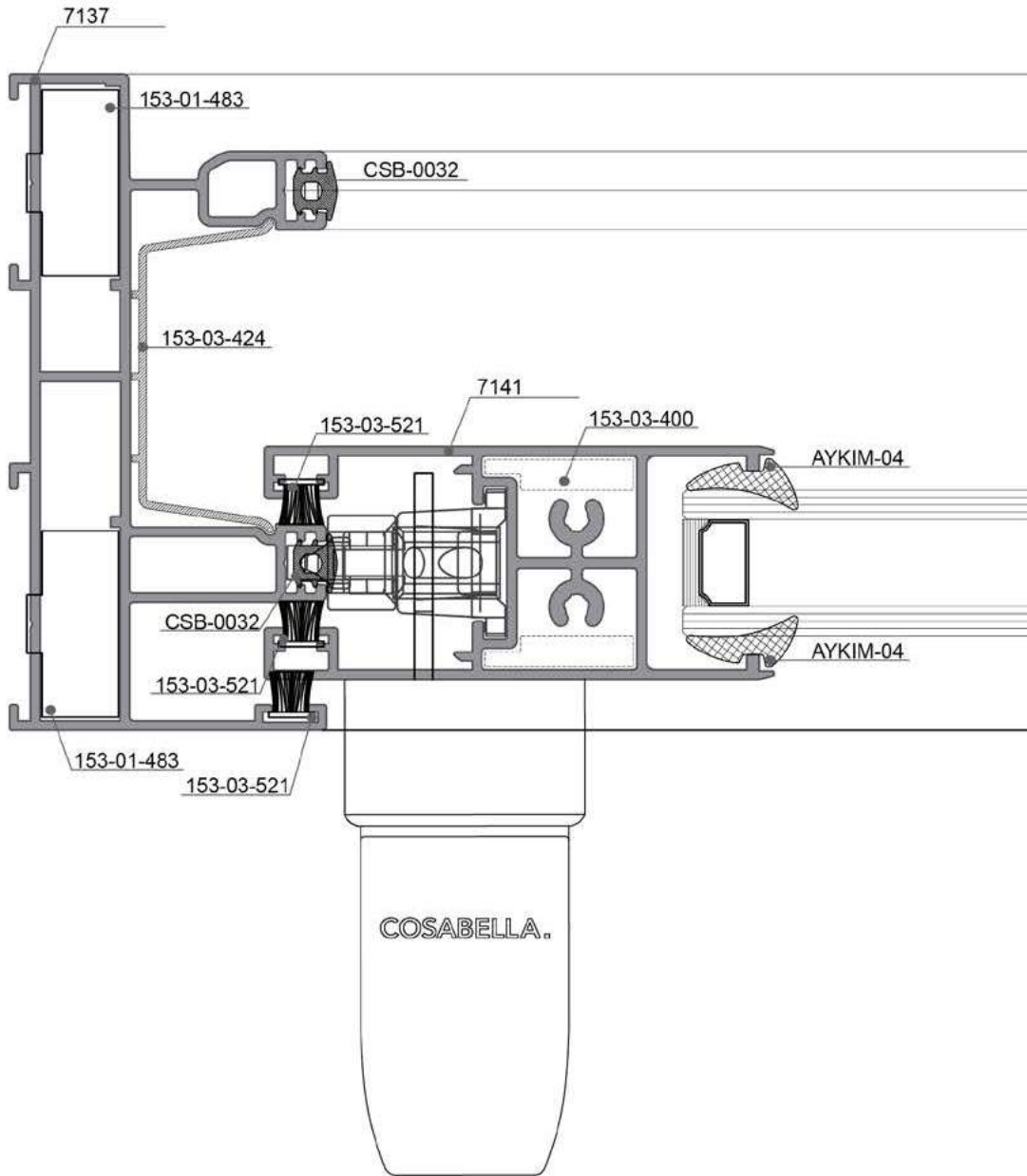
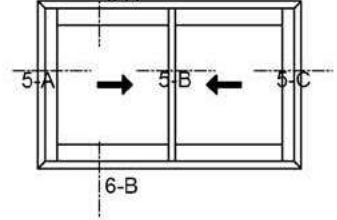
90° Klasik Sürme
 90° Classical Slide 6-A

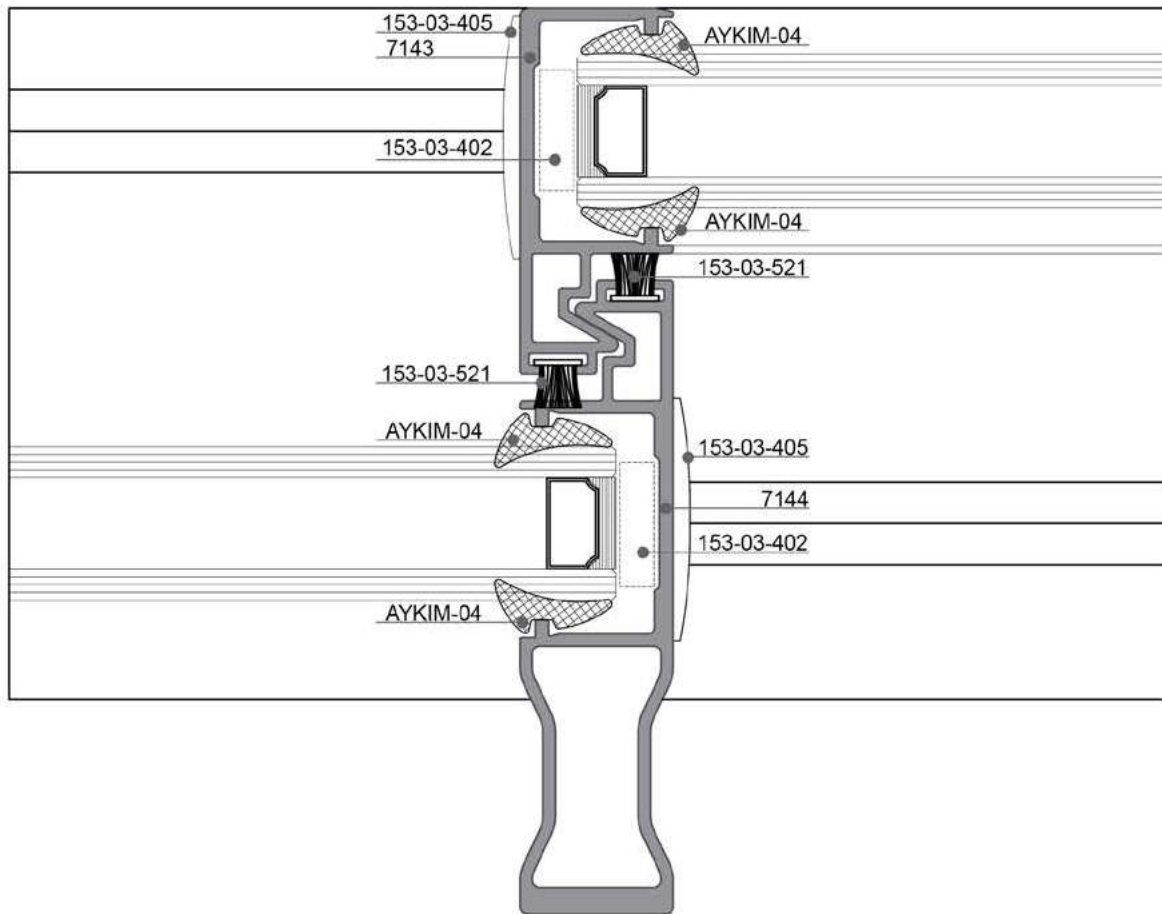
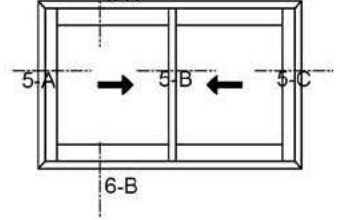
 5-A DETAYI
 DETAIL

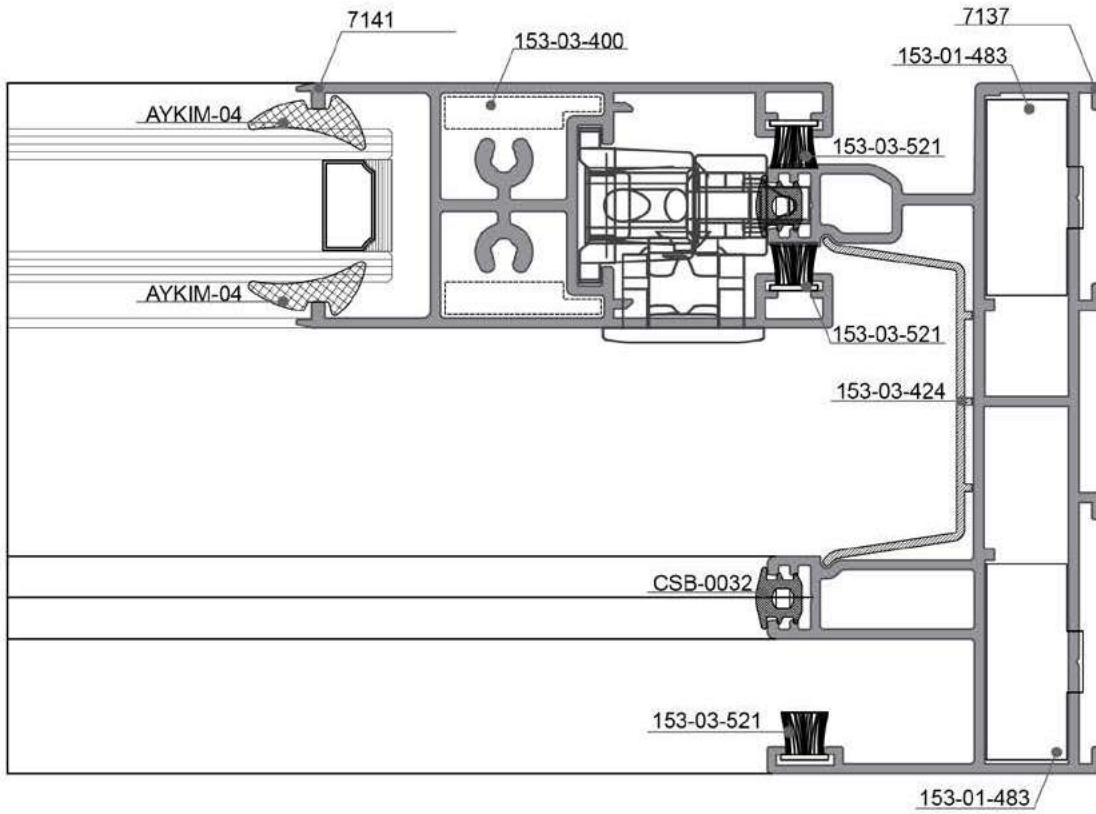
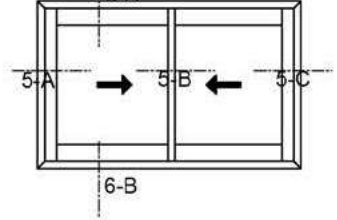
90° Klasik Sürme
90° Classical Slide | 6-A5-B DETAYI
DETAIL

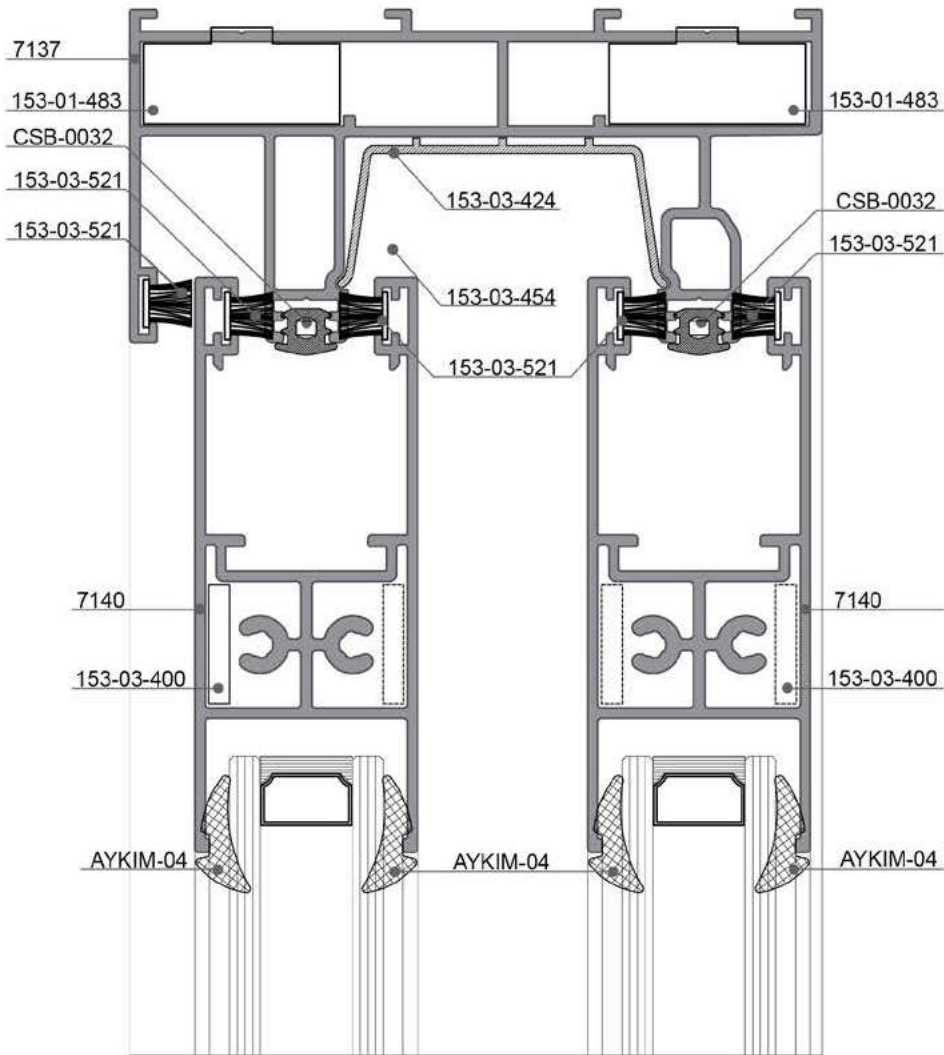
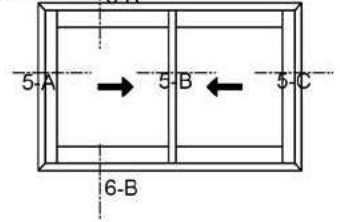
90° Klasik Sürme
 90° Classical Slide | 6-A

 5-C DETAYI
 DETAIL

90° Klasik Sürme
90° Classical Side | 6-A6-A DETAYI
DETAIL

Ölçek: 1:1 / Scale: 1:1

90° Klasik Sürme

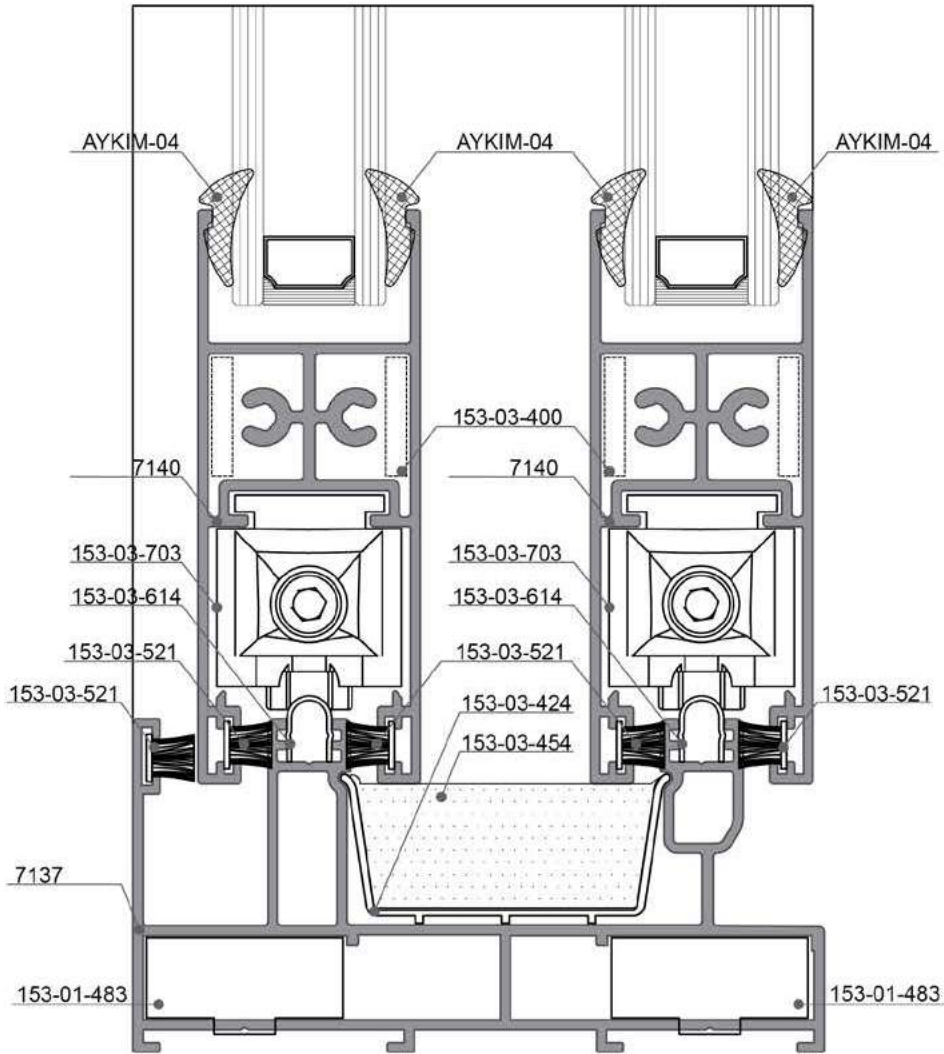
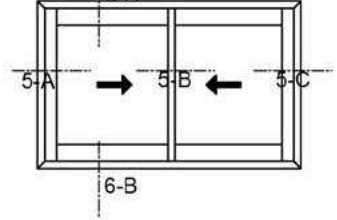
90° Classical Slide | 6-A

 6-B DETAYI
 DETAIL

Ölçek: 1:1 / Scale: 1:1

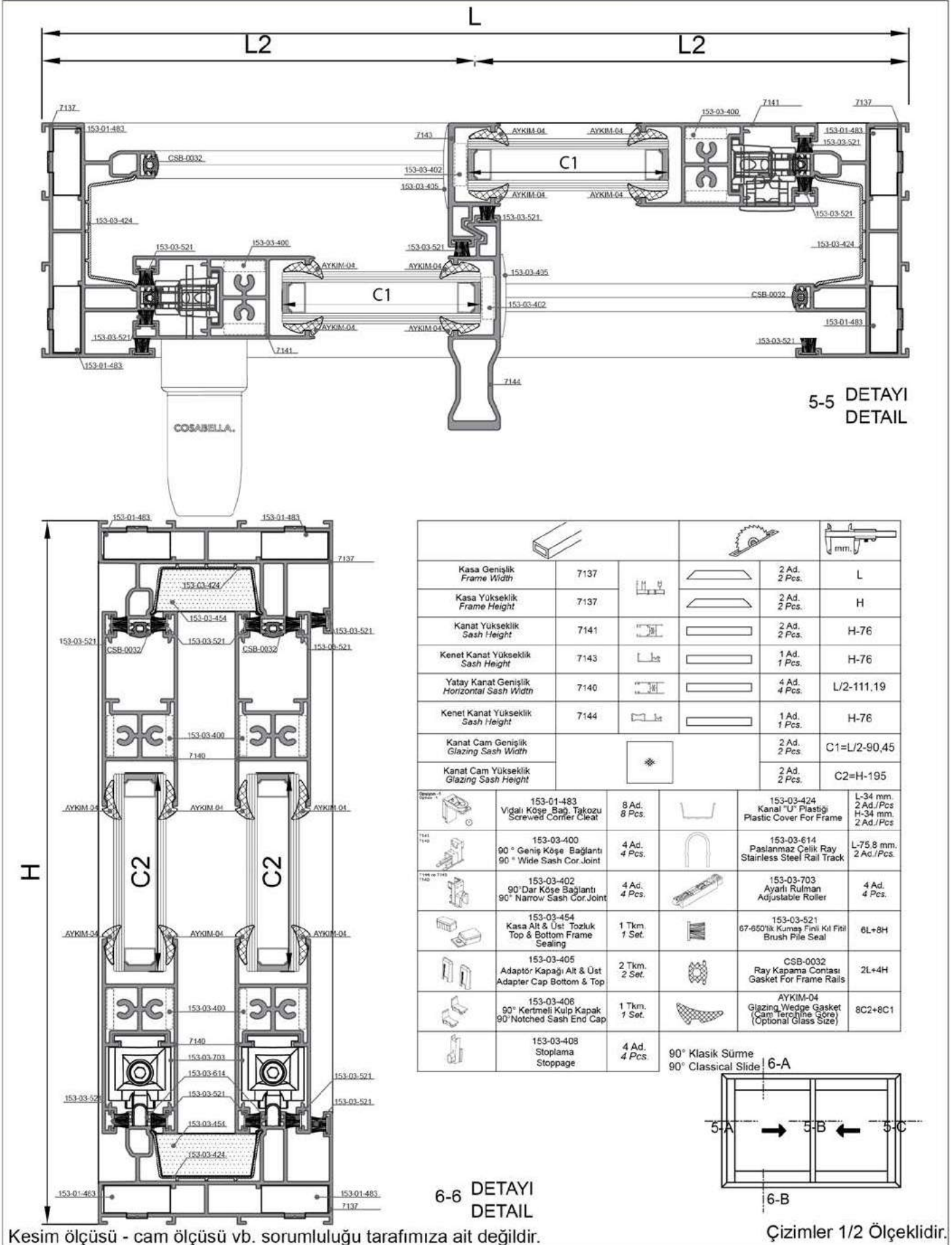

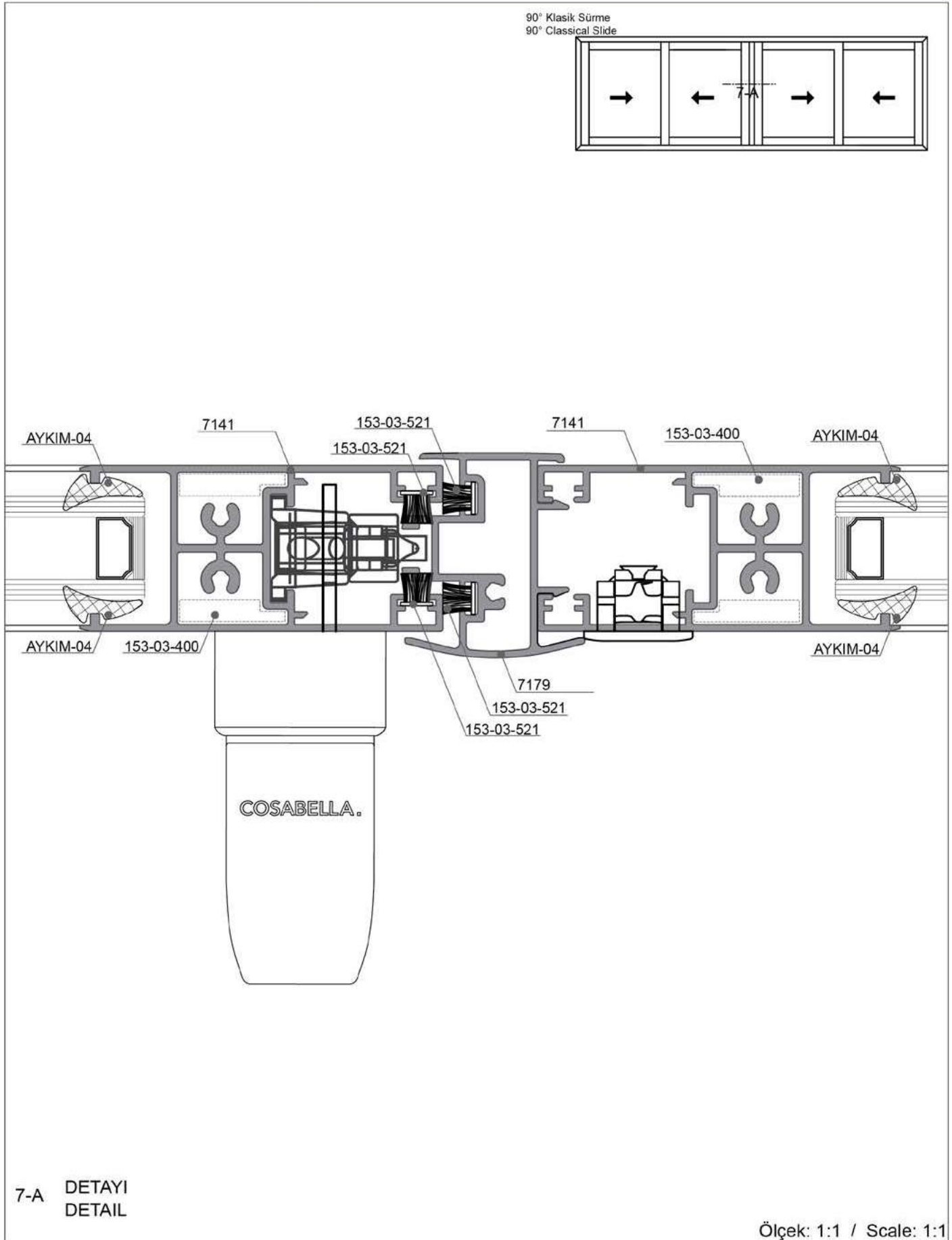

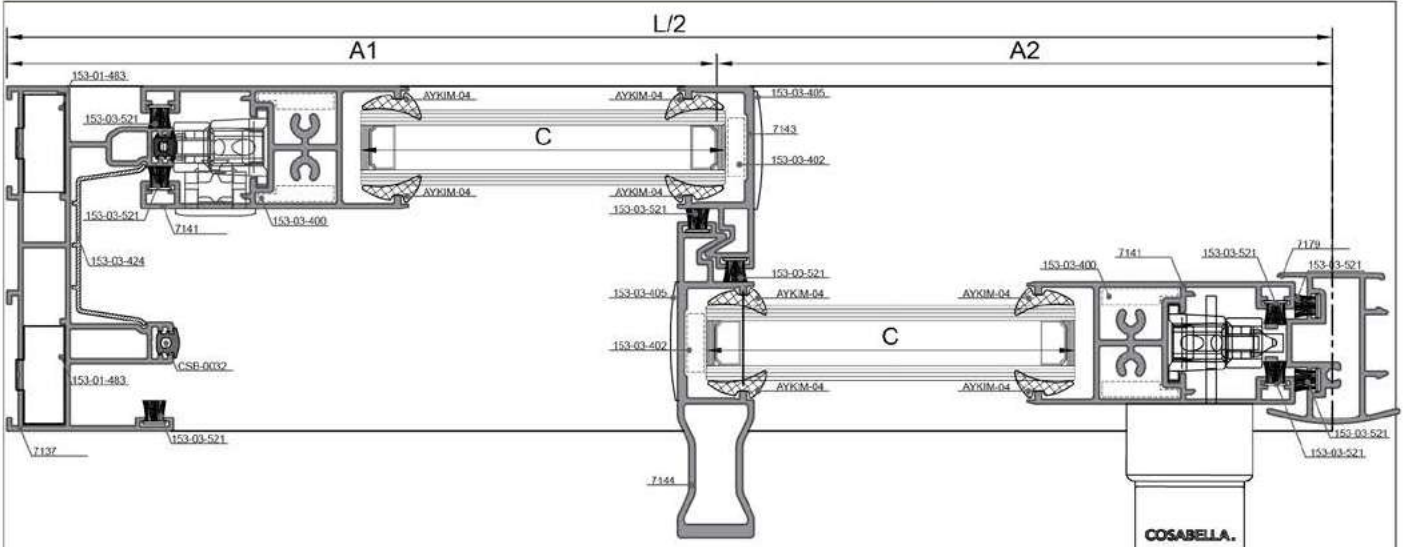

Kasa Genişlik Frame Width	7137			2 Ad. 2 Pcs.	L
Kasa Yükseklik Frame Height	7137			2 Ad. 2 Pcs.	H
Kanat Yükseklik Sash Height	7141			4 Ad. 4 Pcs.	H-76
Yatay Kanat Genişlik Horizontal Sash Width	7140			8 Ad. 8 Pcs.	A1-111,02
Takviyeli Kenet Kanat Yükseklik Sash Height	7144			2 Ad. 2 Pcs.	H-76
Kenet Kanat Yükseklik Sash Height	7143			2 Ad. 2 Pcs.	H-76
Adaptör Profili Yükseklik Adapter Profile Height	7179			1 Ad. 1 Pcs.	H-106
Kanat Cam Genişlik Glazing Sash Width				1 Ad. 1 Pcs.	A1-90,34
Kanat Cam Yükseklik Glazing Sash Height				1 Ad. 1 Pcs.	H-195

	153-01-483 Vidalı Köşe Bağ. Takozu Screwed Corner Cleat	8 Ad. 8 Pcs.		153-03-424 Kanal "U" Plastik Plastic Cover For Frame	L-34 mm. 2 Ad./Pcs. H-34 mm. 2 Ad./Pcs.
	153-03-400 90° Geniş Köşe Bağlantı 90° Wide Sash Cor.Joint	8 Ad. 8 Pcs.		153-03-614 Paslanmaz Çelik Ray Stainless Steel Rail Track	L-75,8 mm. 2 Ad./Pcs.
	153-03-402 90° Dar Köşe Bağlantı 90° Narrow Sash Cor.Joint	8 Ad. 8 Pcs.		153-03-703 Ayarlı Rulman Adjustable Roller	8 Ad. 8 Pcs.
	153-03-454 Kasa Alt & Üst Tozluk Top & Bottom Frame Sealing	2 Tkm. 2 Set.		153-03-408 Stoplama Stoppage	8 Ad. 8 Pcs.
	153-03-405 Adaptör Kapağı Alt & Üst Adapter Cap Bottom & Top	4 Tkm. 4 Set.		153-03-521 67-650'li Kumuş Fınlı Kıl Fıtlı Brush Pile Seal	6L+14H
	153-03-406 90° Kertmeli Kulüp Kapak 90° Notched Sash End Cap	2 Tkm. 2 Set.		CSB-0032 Ray Kapama Contası Gasket For Frame Rails	2L+4H
	153-03-407 4'lü Kanat Adaptör Kapağı Cosabella 332-T 4 Winged Lid	1 Tkm. 1 Set.		AYKIM-04 Glazing Wedge Gasket (Cam Terçihine Göre) (Optional Glass Size)	16C+16C2

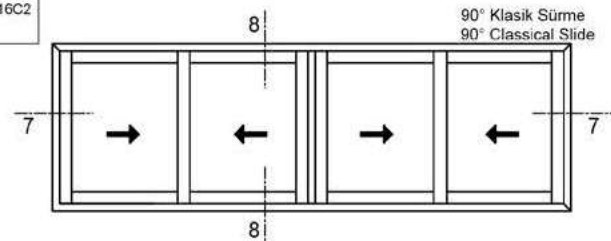

Kesim ölçüsü - cam ölçüsü vb. sorumluluğu tarafımıza ait değildir.

Çizimler 1/2 ölçeklidir.

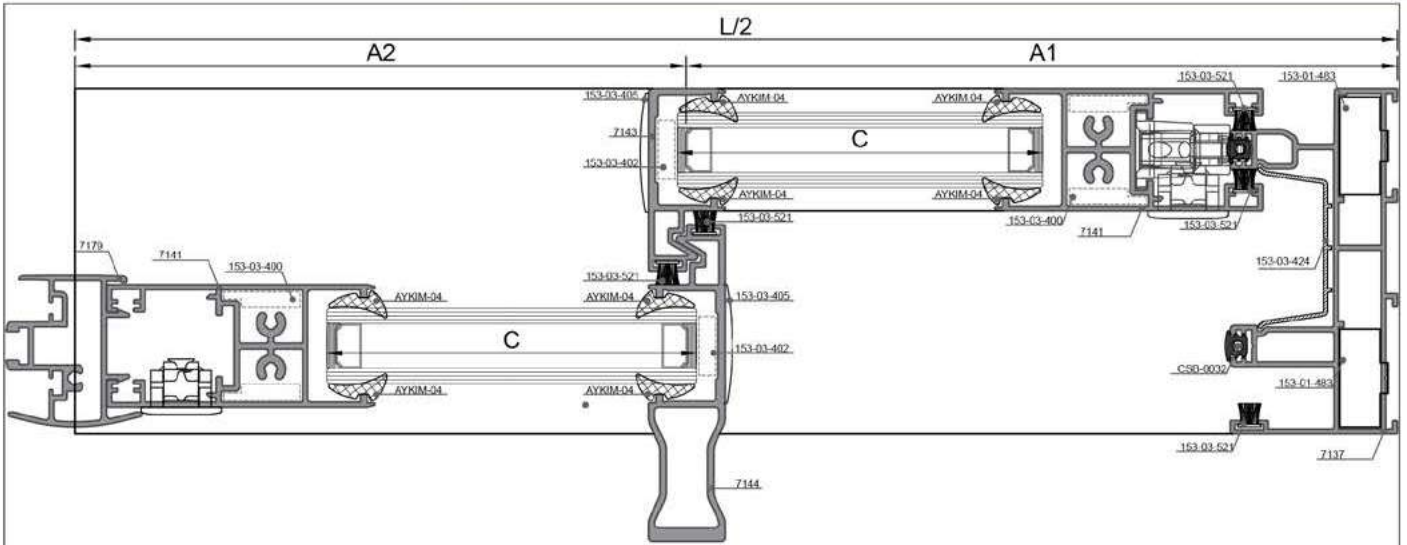
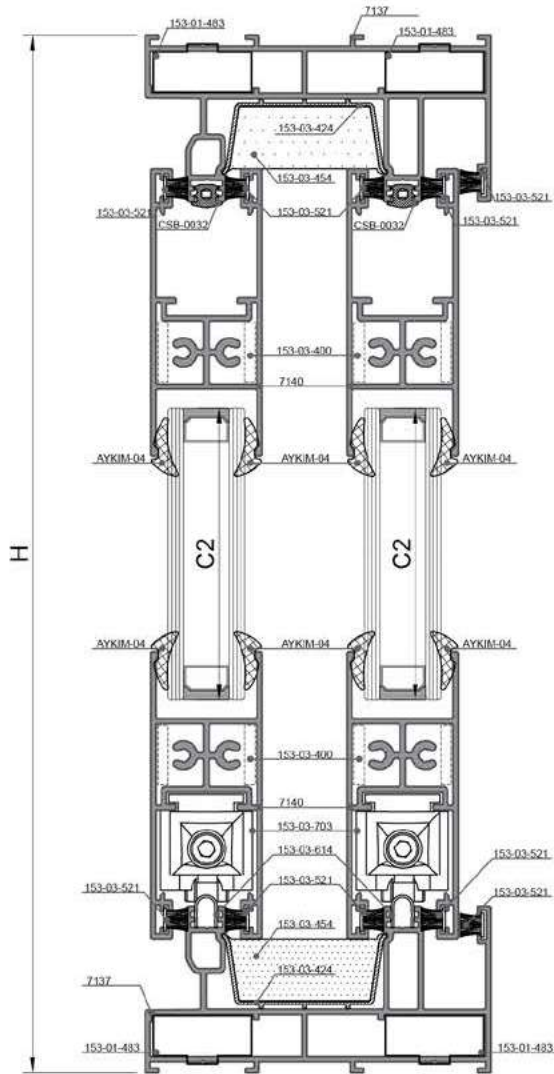
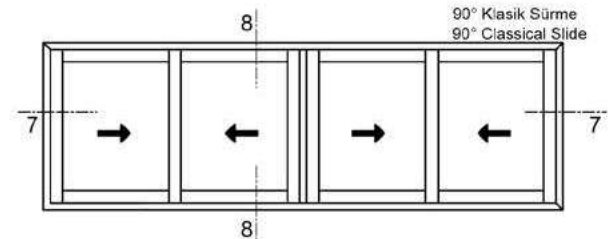

 7-7 DETAYI
 DETAIL

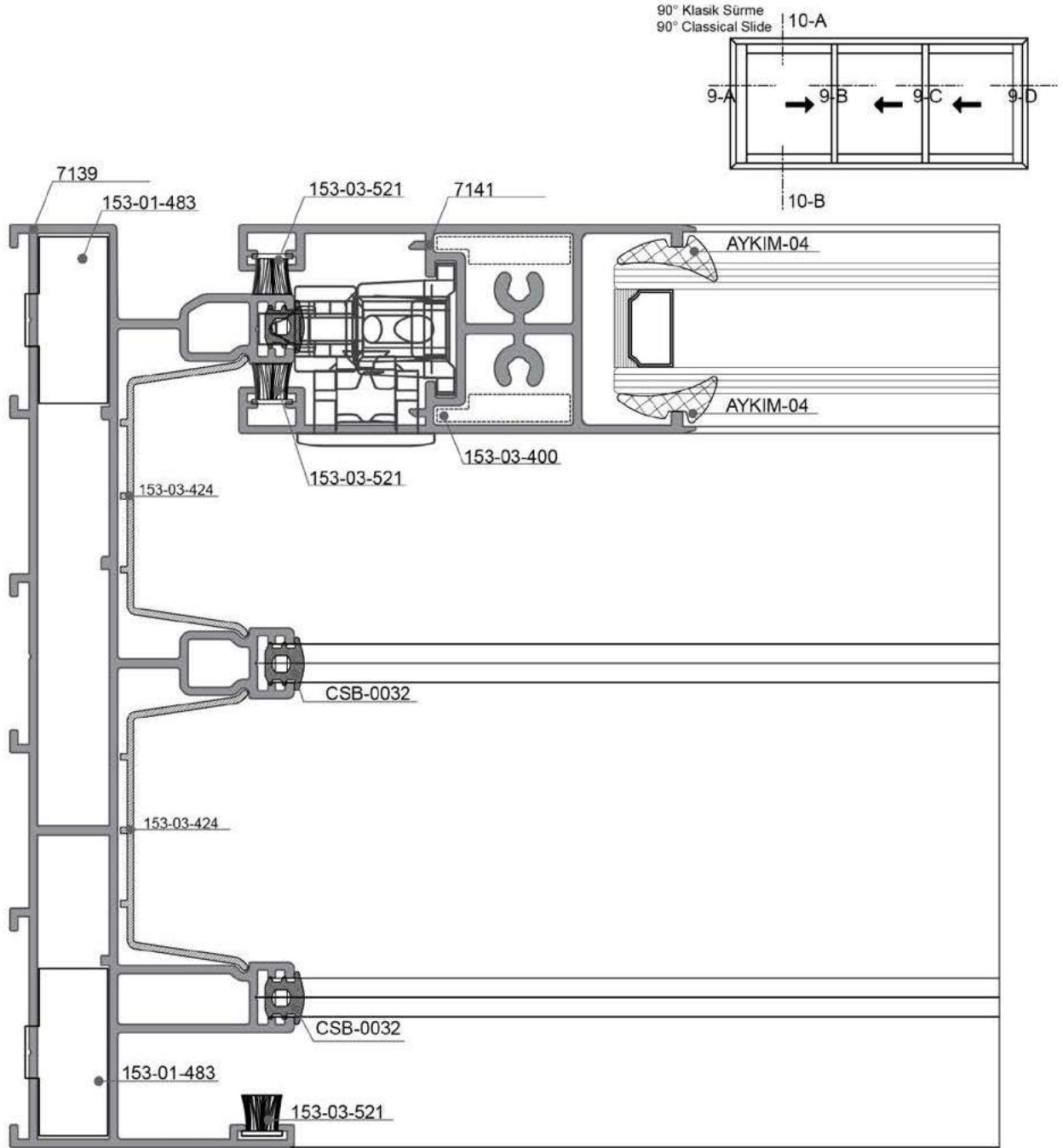
 8-8 DETAYI
 DETAIL

Çizimler 1/2 ölçeklidir.

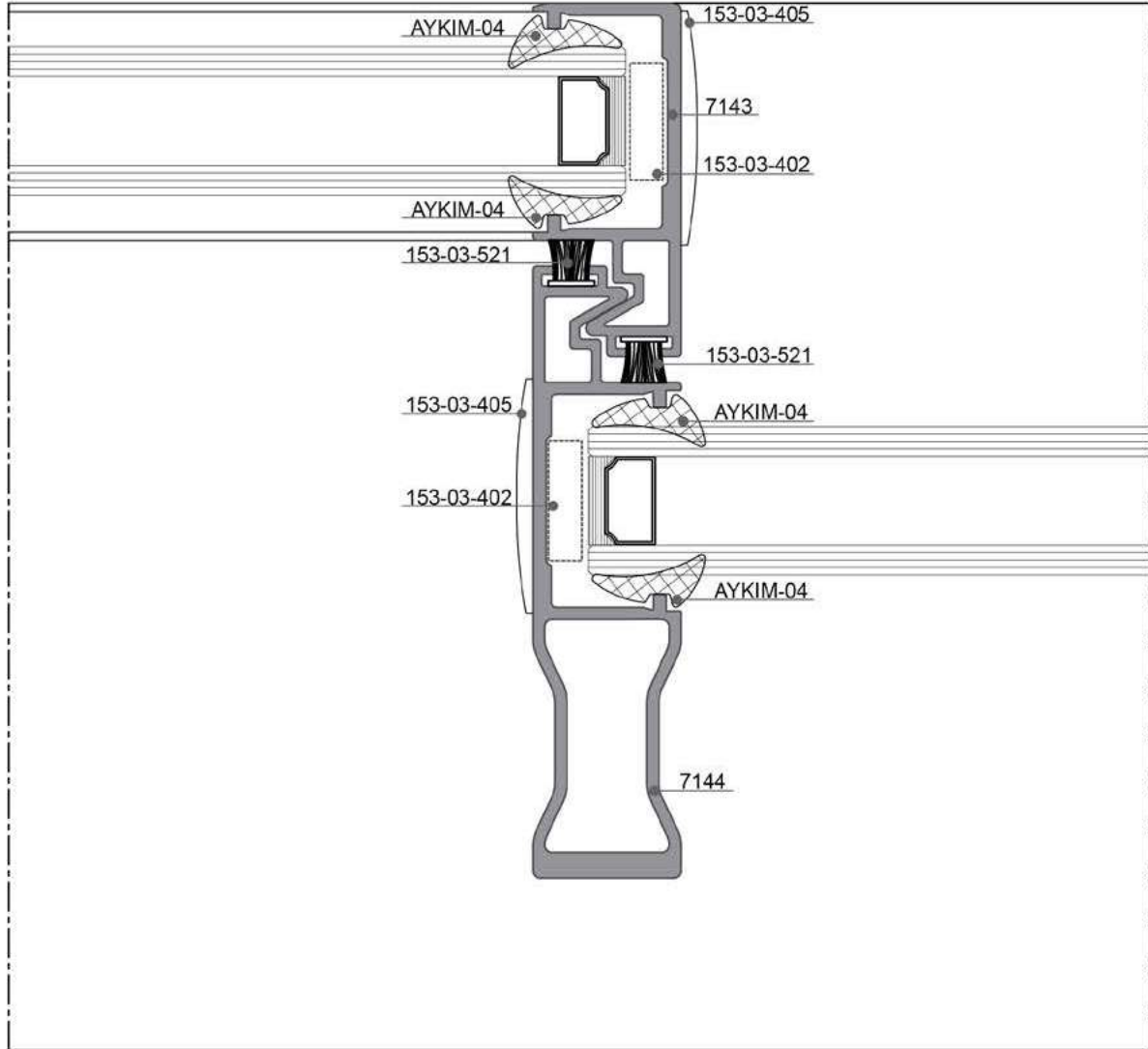
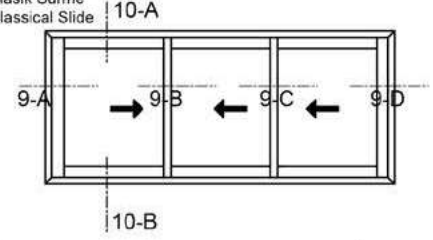

9-A DETAYI
DETAIL

Ölçek: 1:1 Scale: 1:1

90° Klasik Sürme
 90° Classical Slide

 9-B DETAYI
 DETAIL

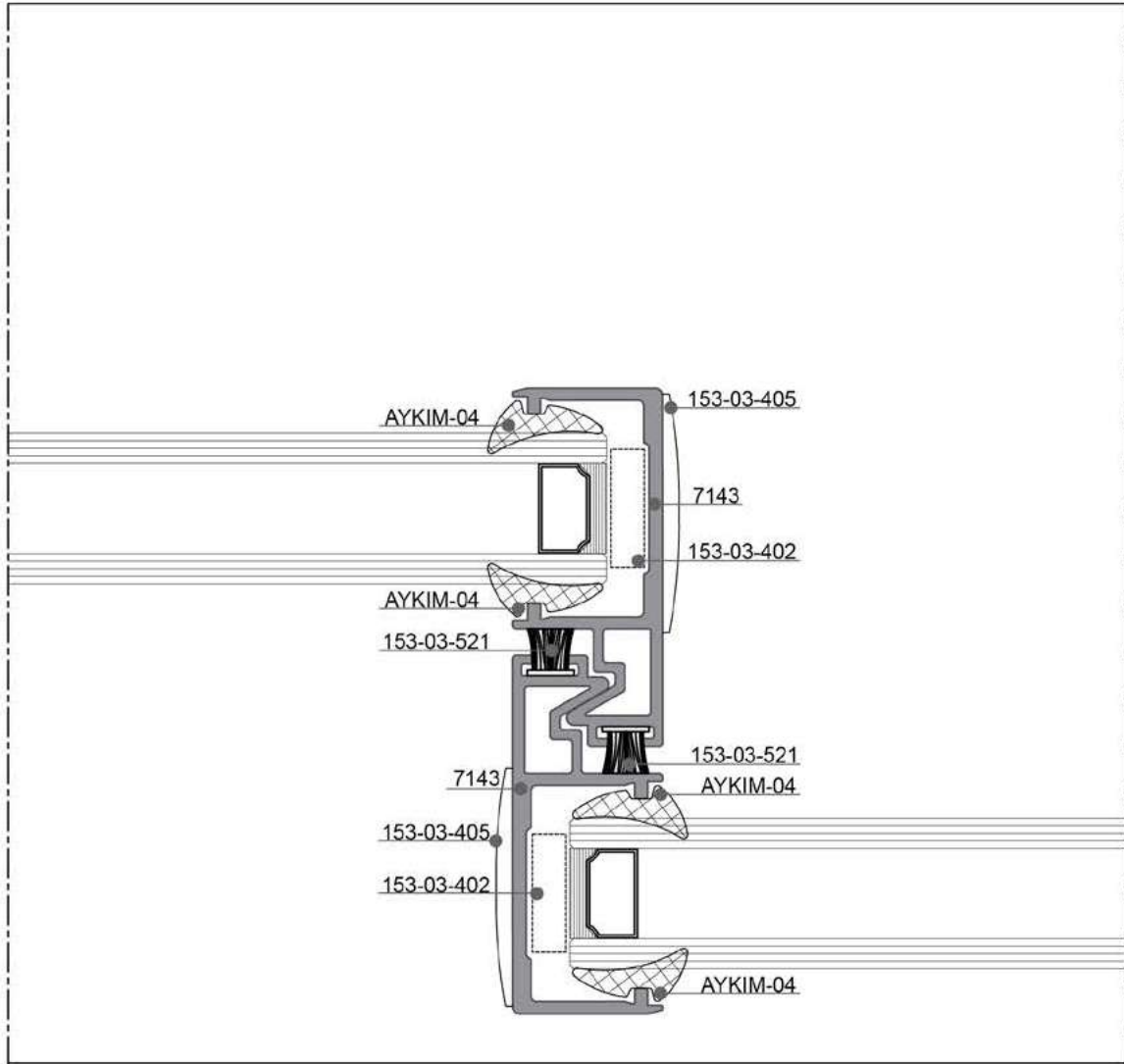
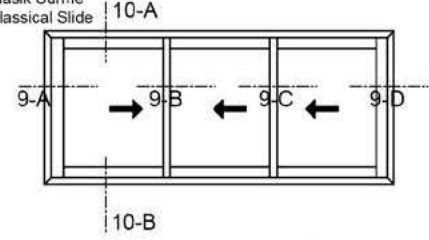
Ölçek: 1:1 Scale: 1:1

90° Klasik Sürme
90° Classical Slide9-C DETAYI
DETAIL

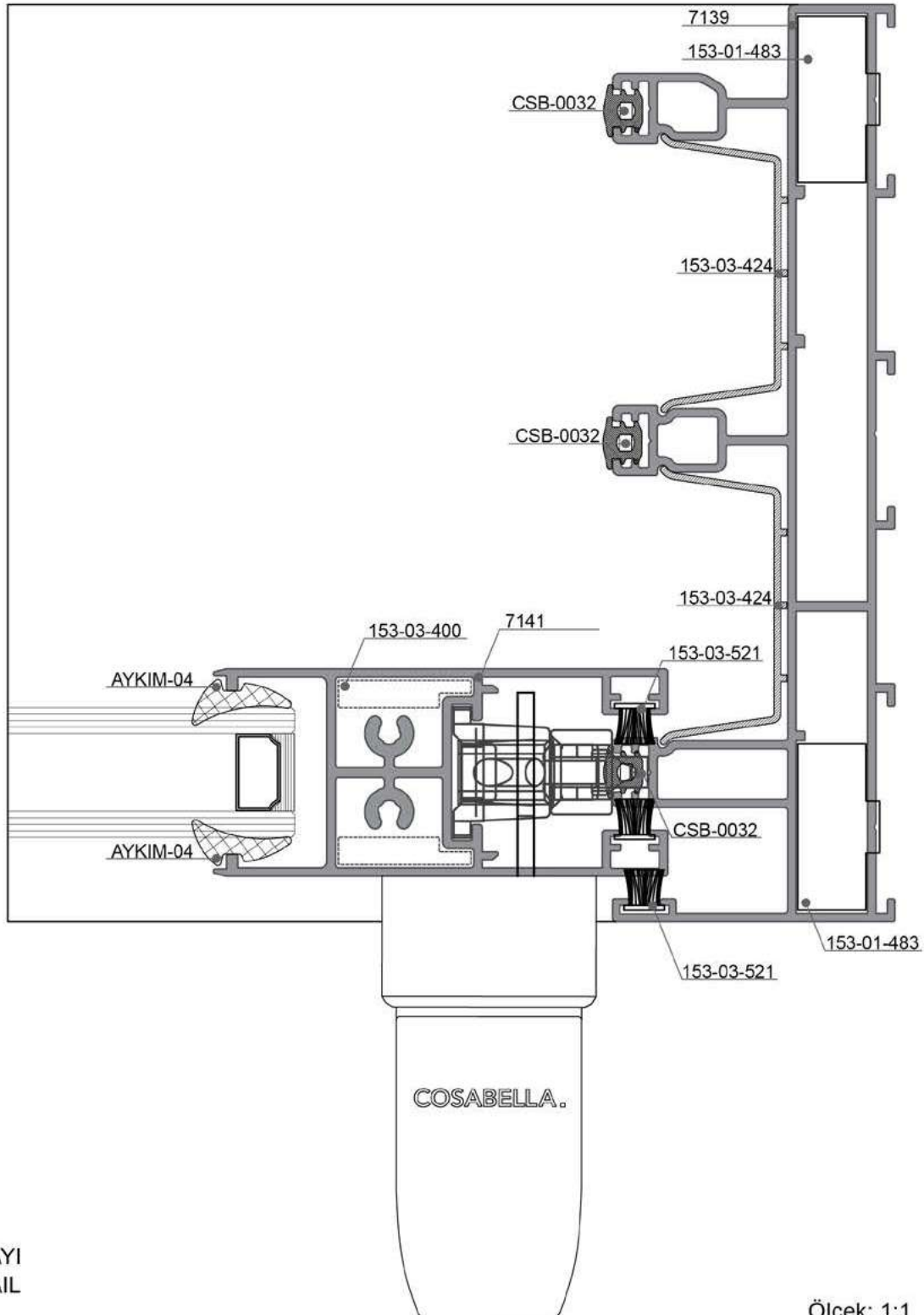
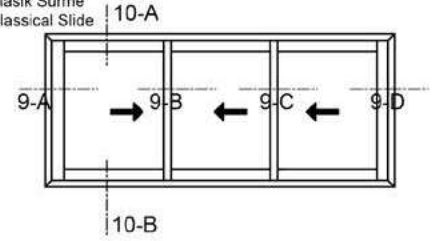
Ölçek: 1:1 Scale: 1:1

90° Klasik Sürme
 90° Classical Slide

 9-D
 DETAYI
 DETAIL

Ölçek: 1:1 Scale: 1:1

90° Klasik Sürme
90° Classical Slide

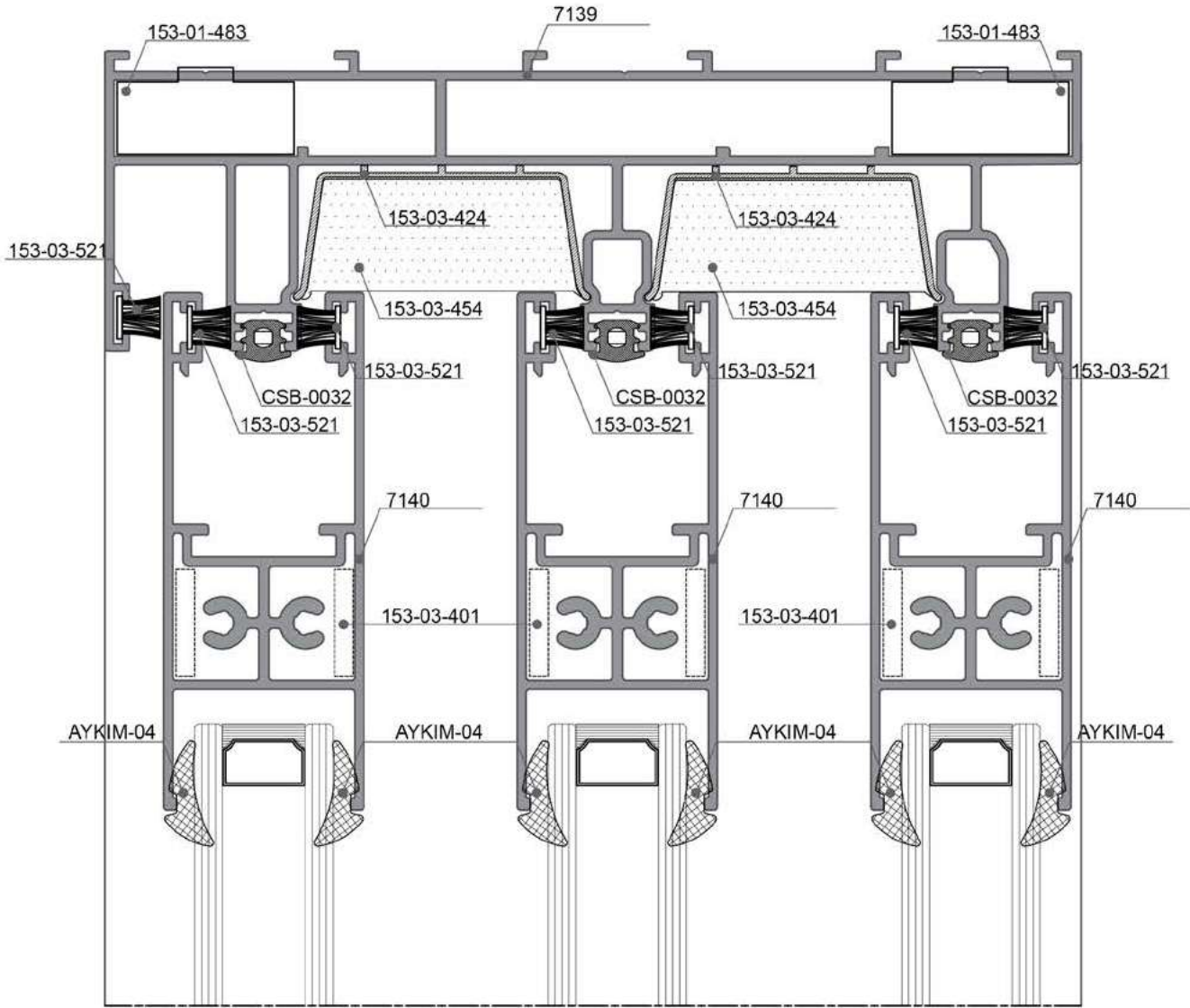
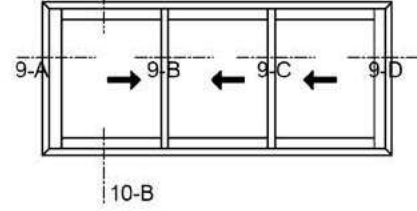
10-A

10-A DETAYI
DETAIL

Ölçek: 1:1 Scale: 1:1

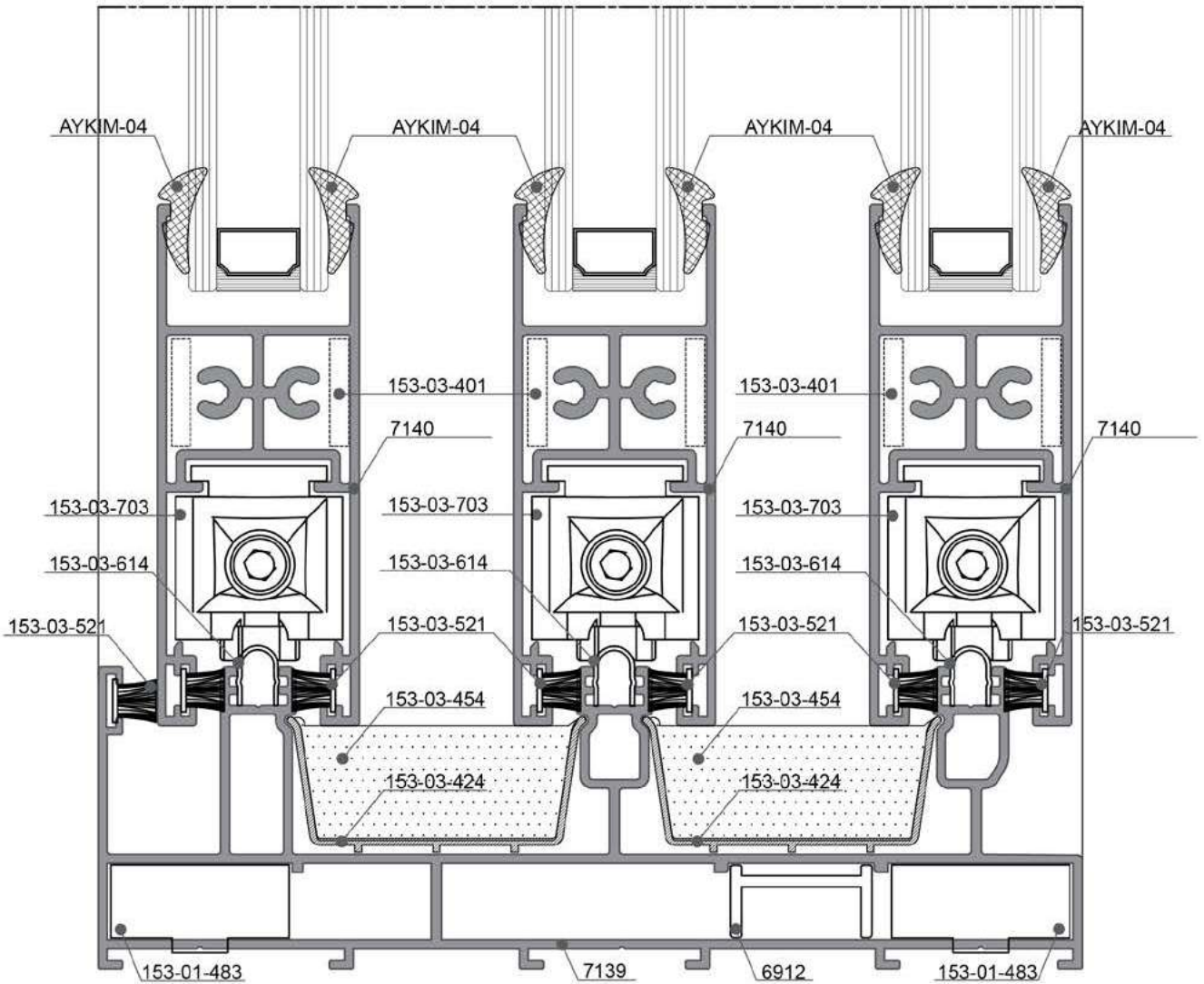
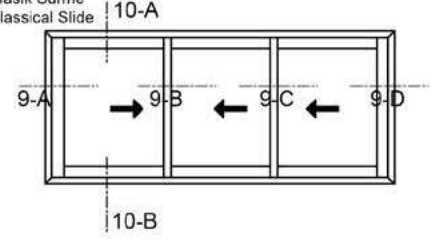
90° Klasik Sürme
 90° Classical Slide

 10-B DETAYI
 DETAIL

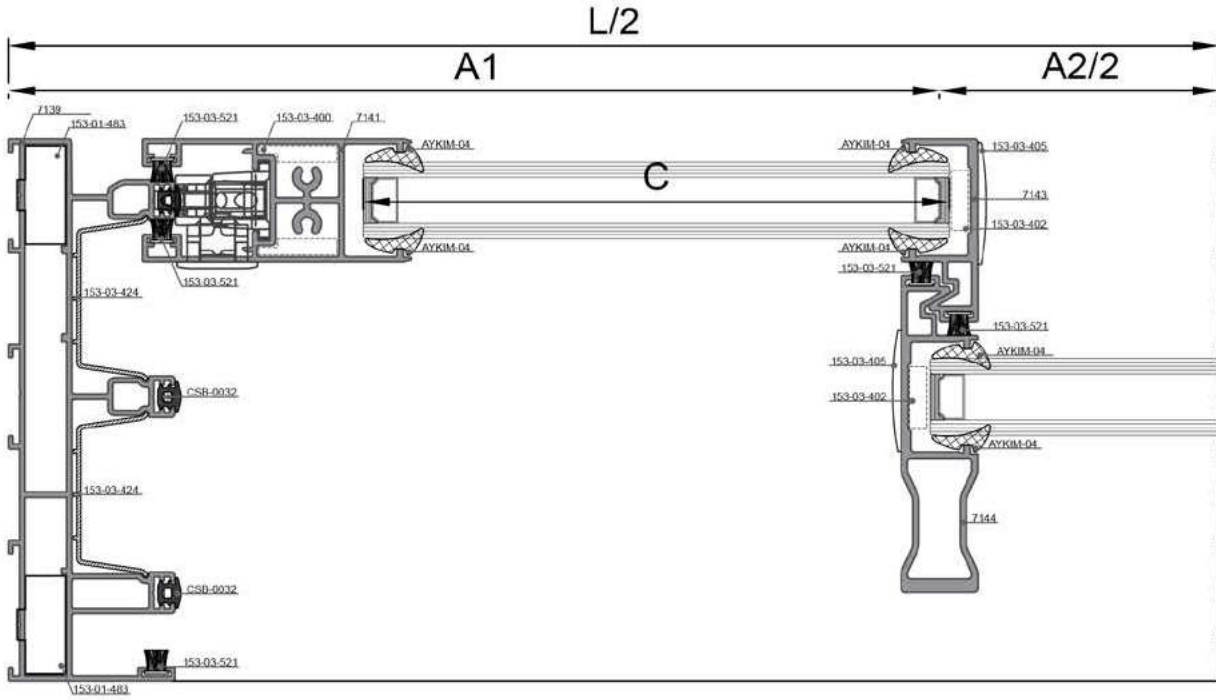
Ölçek: 1:1 Scale: 1:1

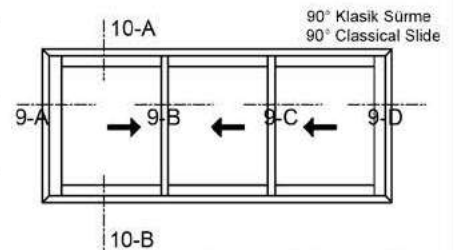

	Kasa Genişlik Frame Width	7139		2 Ad. 2 Pcs.	L
	Kasa Yükseklik Frame Height	7139		2 Ad. 2 Pcs.	H
	Kanat Yükseklik Sash Height	7141		2 Ad. 2 Pcs.	H-76
	Yatay Kanat Genişlik Horizontal Sash Width	7140		6 Ad. 6 Pcs.	A1-111,12
	Kenet Kanat Yükseklik Sash Height	7143		3 Ad. 3 Pcs.	H-76
	Kenet Kanat Yükseklik Sash Height	7144		1 Ad. 1 Pcs.	H-76
	Kanat Cam Genişlik Glazing Sash Width			3 Ad. 3 Pcs.	C=A1-90
	Kanat Cam Yükseklik Glazing Sash Height			3 Ad. 3 Pcs.	C'=H-195
	153-01-483 Vidalı Köşe Bağ Takozu Screwed Corner Cleat	8 Ad. 8 Pcs.		153-03-614 Paslanmaz Çelik Ray Stainless Steel Rail Track	L-75,8 mm. 3 Ad./Pcs.
	153-03-400 90° Geniş Köşe Bağlantı 90° Wide Sash Cor.Joint	4 Ad. 4 Pcs.		153-03-703 Ayarlı Rulman Adjustable Roller	6 Ad. 6 Pcs.
	153-03-402 90° Dar Köşe Bağlantı 90° Narrow Sash Cor.Joint	8 Ad. 8 Pcs.		153-03-454 Kasa Alt & Üst Tozluk Top & Bottom Frame Sealing	2 Tkm. 2 Set.
	153-03-405 Adaptör Kapağı Alt & Üst Adapter Cap Bottom & Top	4 Tkm. 4 Set.		153-03-521 67-650'lik Kumaş Finli Kıl Fitalı Brush Pile Seal	10H+8L
	153-03-408 Stoplama Stoppage	4 Ad. 4 Pcs.		CSB-0032 Ray Kapama Contası Gasket For Frame Rails	6H+3L
	153-03-406 90° Kertmeli Kulp Kapak 90° Notched Sash End Cap	1 Tkm. 1 Set.		AYKIM-04 Glazing Wedge Gasket (Cam Terçihine Göre) (Optional Glass Size)	12C+12C'
	153-03-424 Kanal "U" Plastik Plastic Cover For Frame	L-34 mm. 2 Ad./Pcs H-34 mm. 2 Ad./Pcs			



Kesim ölçüsü - cam ölçüsü vb. sorumluluğu tarafımıza ait değildir.

Çizimler 1/2 ölçeklidir.

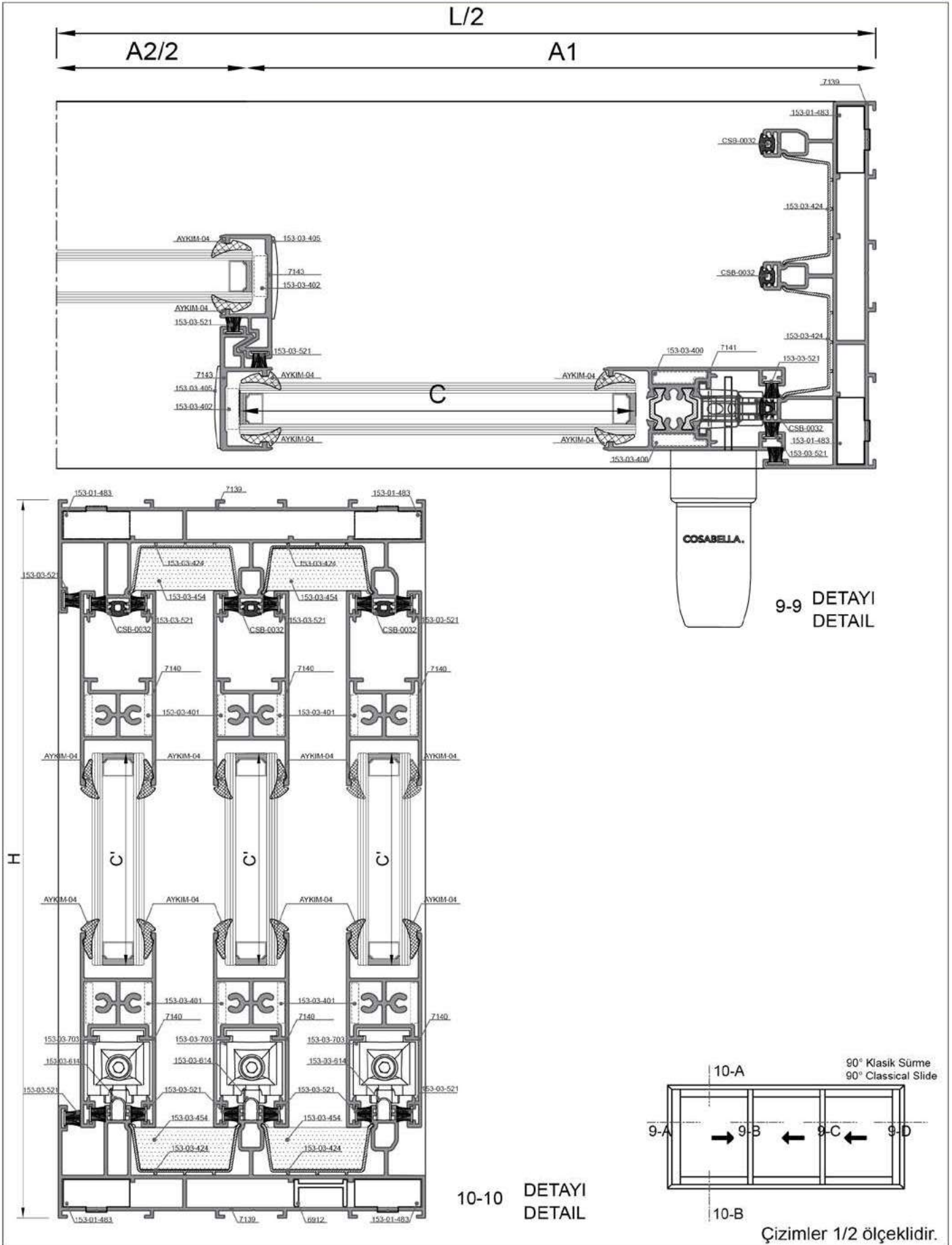

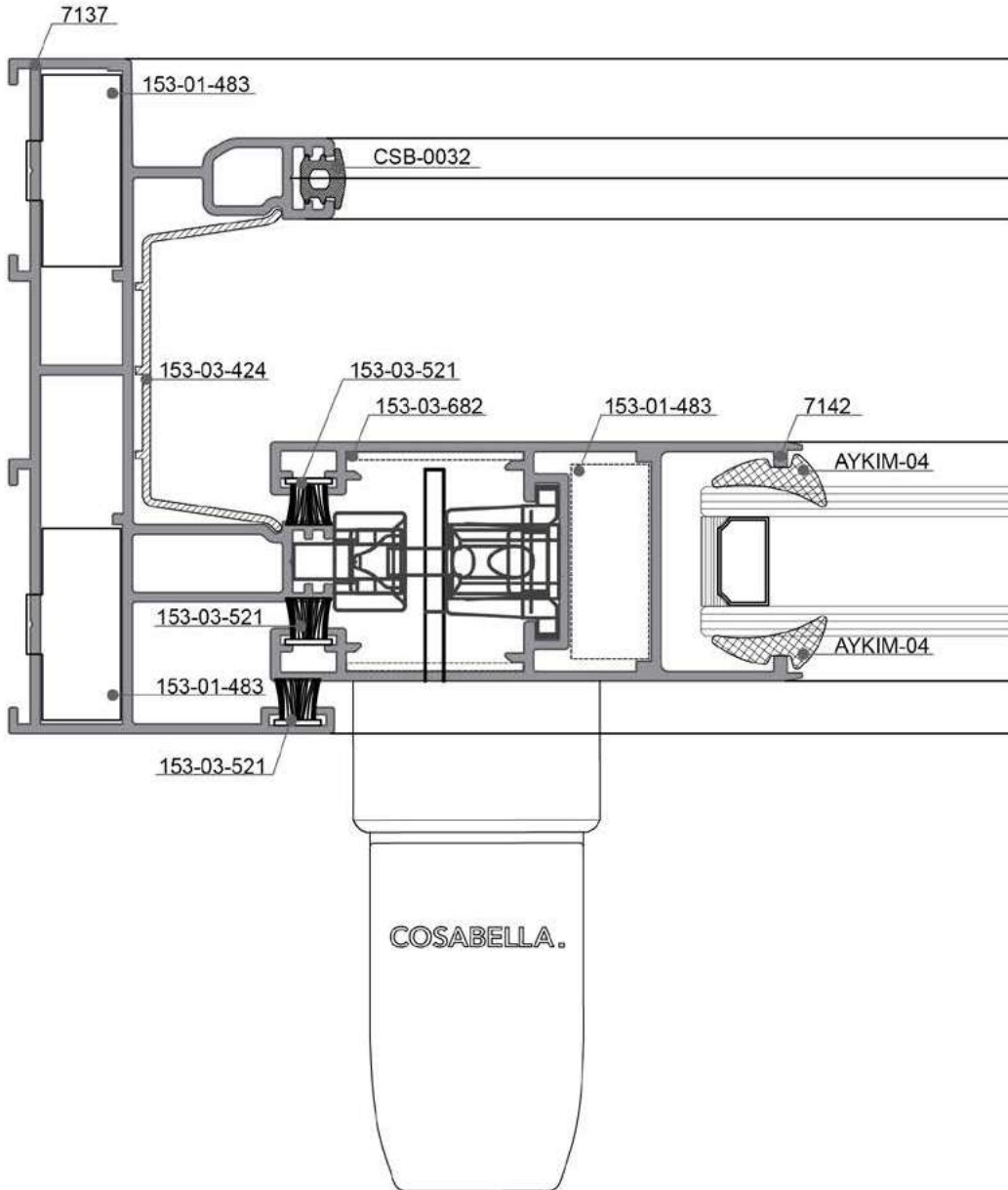
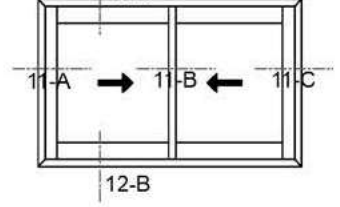
45° Klasik Sürme
45° Classical Slide 12-A11-A DETAYI
DETAIL

Ölçek: 1:1 / Scale: 1:1

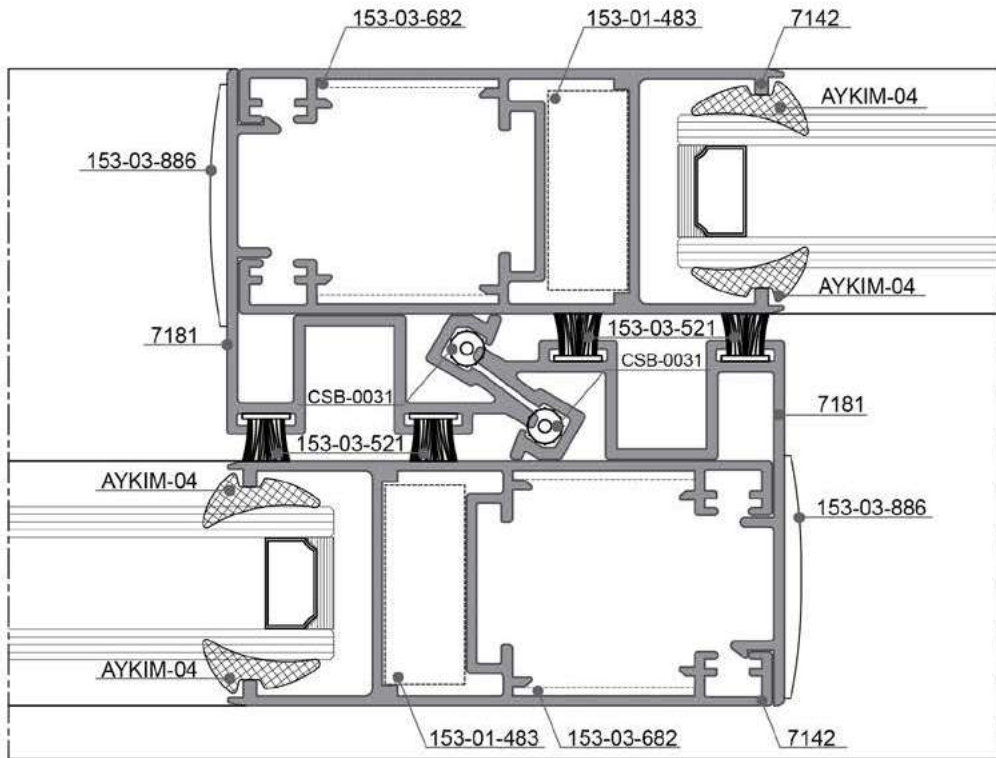
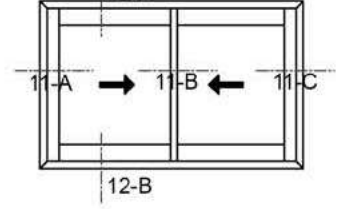
45° Klasik Sürme
 45° Classical Slide: 12-A

 11-B DETAYI
 DETAIL

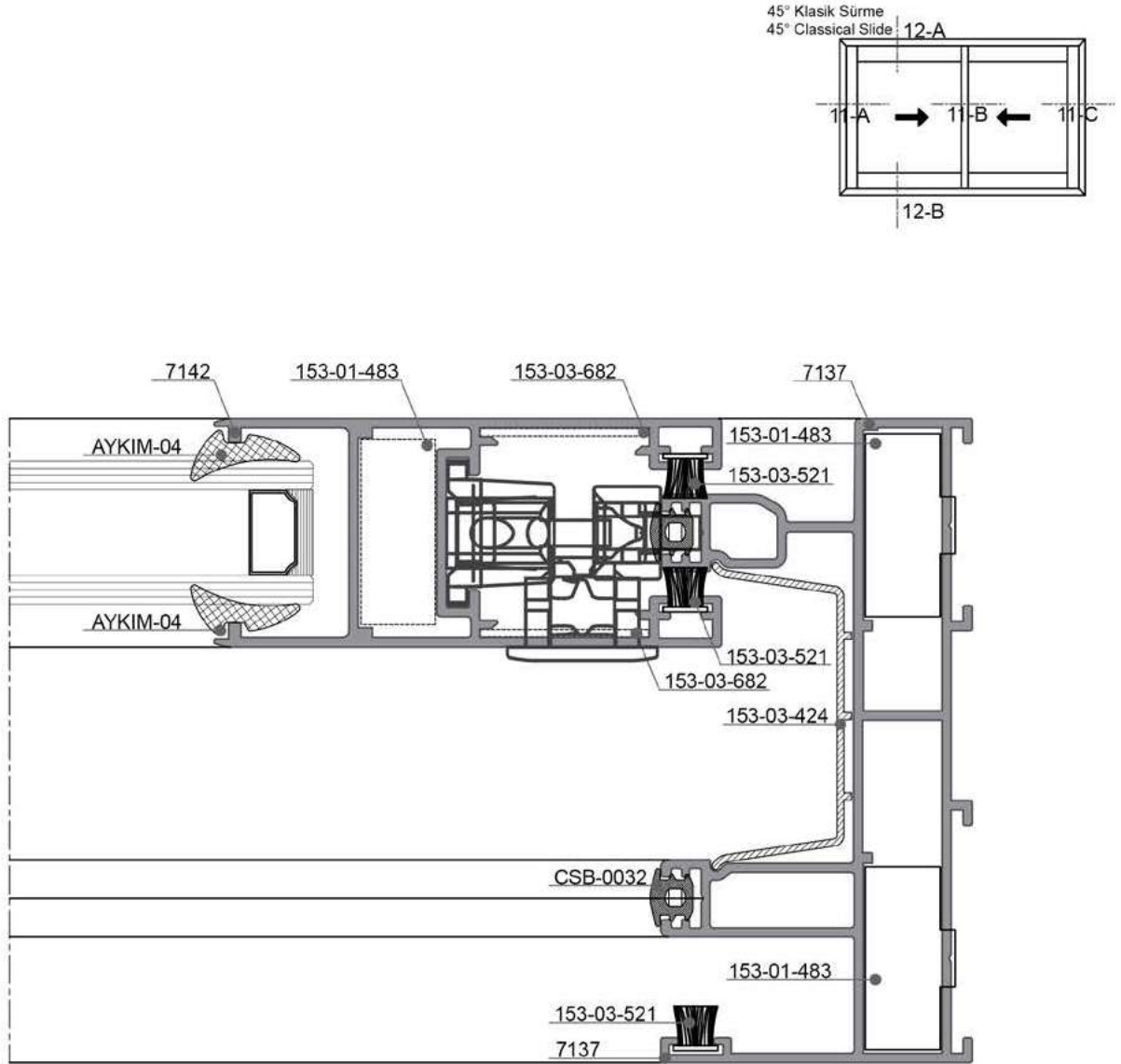
Ölçek: 1:1 / Scale: 1:1

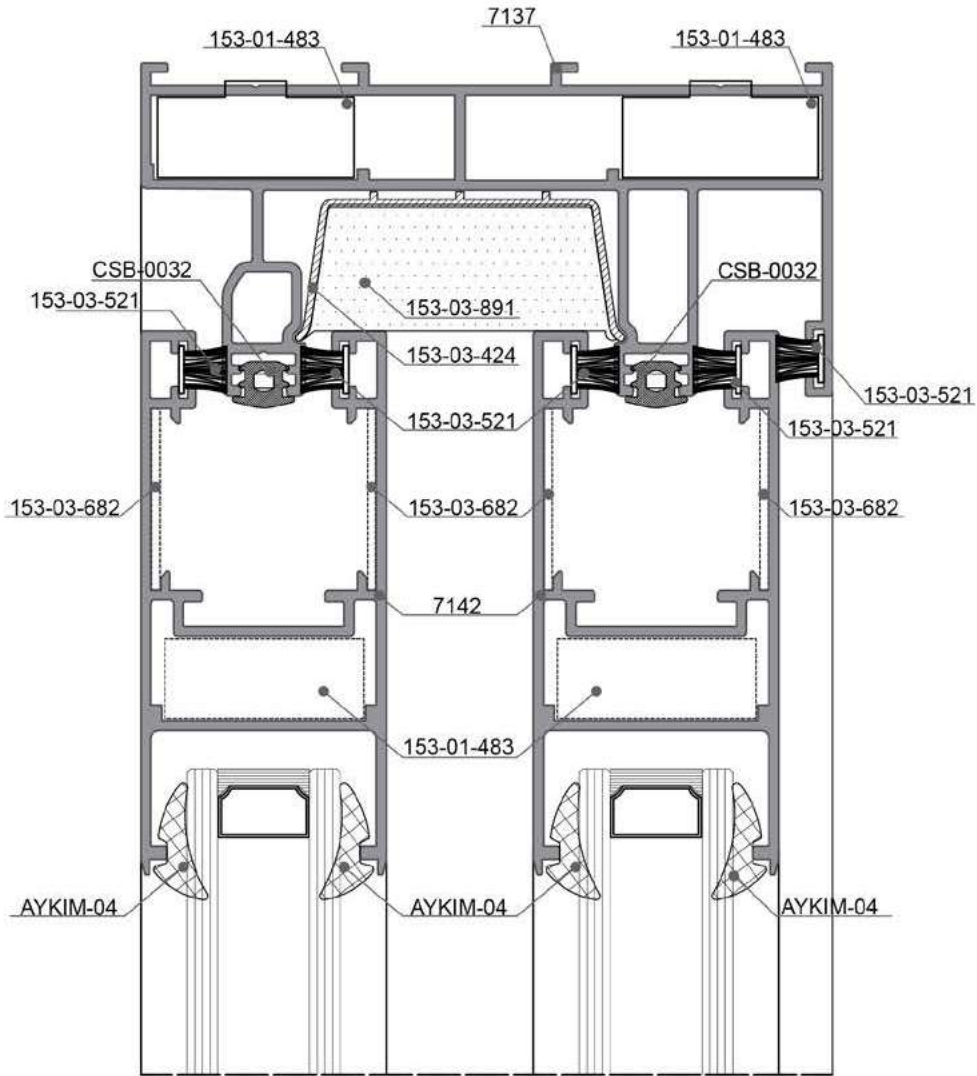
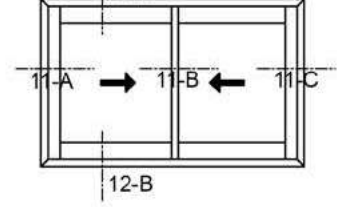

11-C DETAYI
DETAIL

Ölçek: 1:1 / Scale: 1:1

45° Klasik Sürme
 45° Classical Slide: 12-A

 12-A DETAYI
 DETAIL

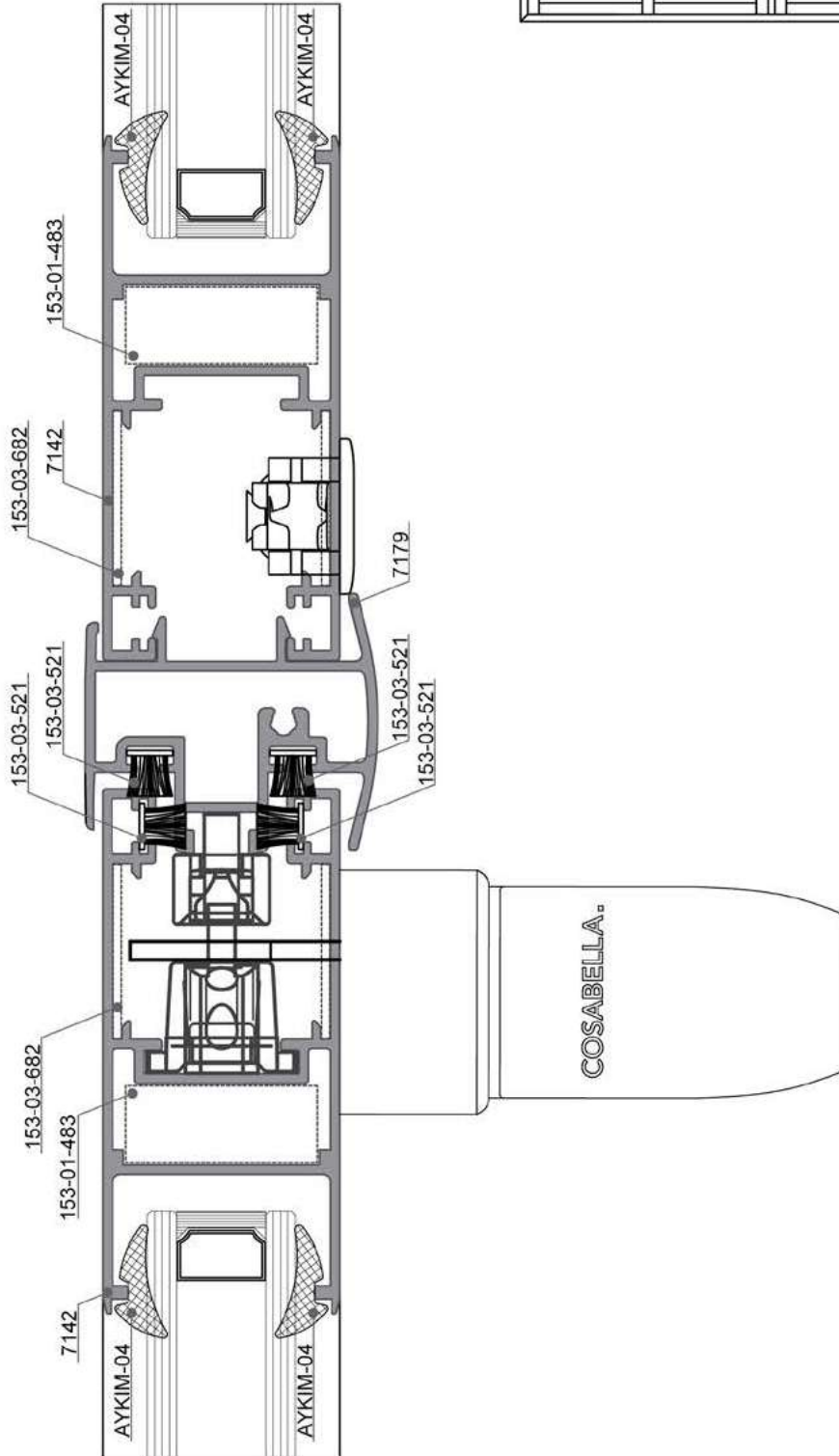
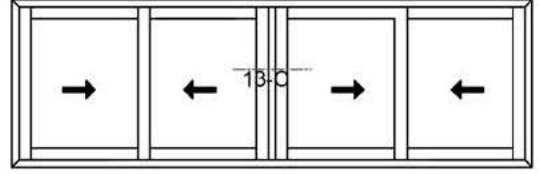
Ölçek: 1:1 / Scale: 1:1

45° Klasik Sürme
45° Classical Slide13-C DETAYI
DETAIL

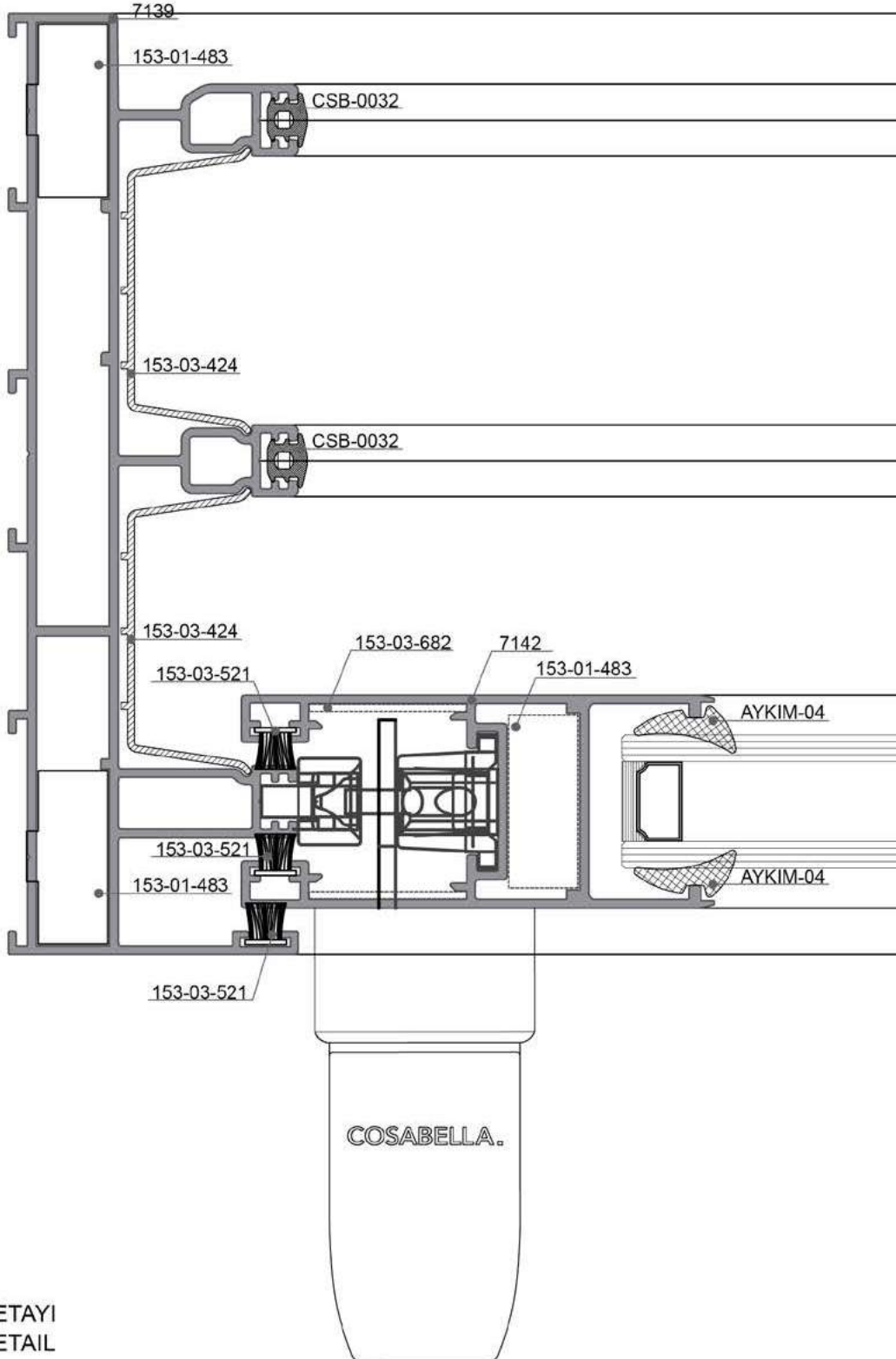
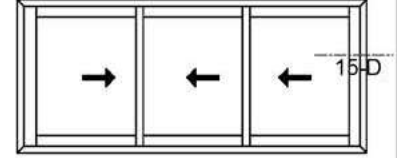
Ölçek: 1:1 / Scale: 1:1

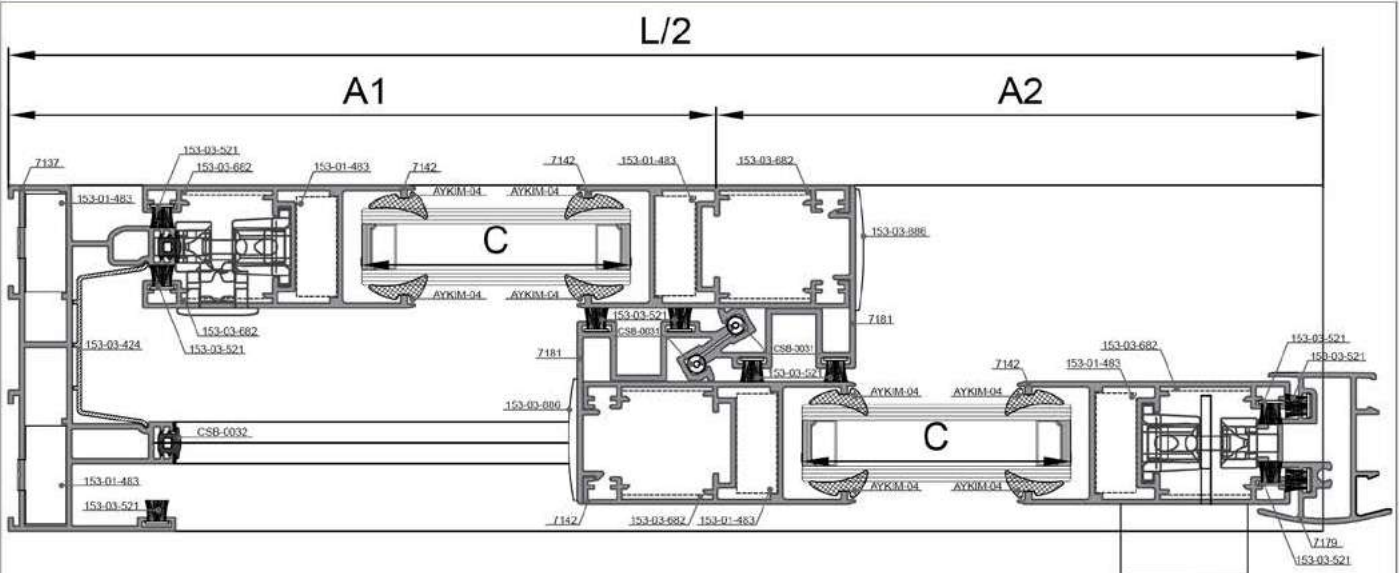
45° Klasik Sürme
 45 Classical Slide

 15-D DETAYI
 DETAIL

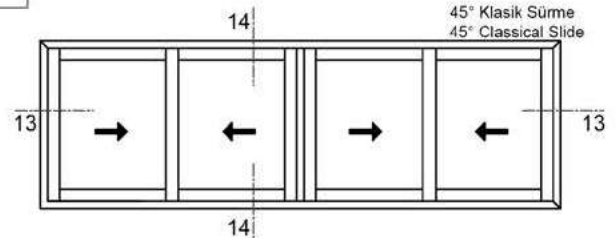

Kasa Genişlik Frame Width	7137			2 Ad. 2 Pcs.	L
Kasa Yükseklik Frame Height	7137			2 Ad. 2 Pcs.	H
Kanat Genişlik Sash Width	7142			8 Ad. 8 Pcs.	A1+6,16
Kanat Yükseklik Sash Height	7142			8 Ad. 8 Pcs.	H-70
Kenet Adaptör Yükseklik Adapter Height	7181			4 Ad. 4 Pcs.	H-70
Adaptör Profili Yükseklik Adapter Profile Height	7179			1 Ad. 1 Pcs.	H-106
Kanat Cam Genişlik Glazing Sash Width				1 Ad. 1 Pcs.	A1-141
Kanat Cam Yükseklik Glazing Sash Height				1 Ad. 1 Pcs.	H-217

	153-01-483 Vıgalı Köşe Bağ Takozu Screwed Corner Cleat	24 Ad. 24 Pcs.		153-03-614 Paslanmaz Çelik Ray Stainless Steel Rail Track	L-75,8 mm. 2 Ad./Pcs.
	153-03-891 Kasa Alt & Üst Tozluk Top & Bottom Frame Sealing	2 Tkm. 2 Set.		153-03-703 Ayarlı Rulman Adjustable Roller	8 Ad. 8 Pcs.
	153-03-886 Adaptör Kapağı Alt & Üst Adapter Cap Bottom & Top	4 Tkm. 4 Set.		153-03-682 Köşe Gönye Alignment Square	16 Ad. 16 Pcs.
	153-03-407 4'lü Kanat Adaptör Kapağı Cosabella S32-T 4 Winged Lid	1 Tkm. 1 Set.		153-03-521 67-850'li Kumaş Fınlı Kıl Fıtlı Brush Pile Seal	6L+18H
	153-03-408 Stoplama Stoppage	8 Ad. 8 Pcs.		CSB-0032 Ray Kapama Contası Gasket For Frame Rails	2L+4H
	153-03-888 Sallantı Engelleyici Shake Reducer	4 Ad. 4 Pcs.		AYKIM-04 Glazing Wedge Gasket (Cam Terçhine Göre) (Optional Glass Size)	16C+16C'
	153-03-424 Kanal "U" Plastik Plastic Cover For Frame	L-34 mm. 2 Ad./Pcs. H-34 mm. 2 Ad./Pcs.			



Kesim ölçüsü - cam ölçüsü vb. sorumluluğu tarafımıza ait değildir.

Çizimler 1/2 ölçeklidir.

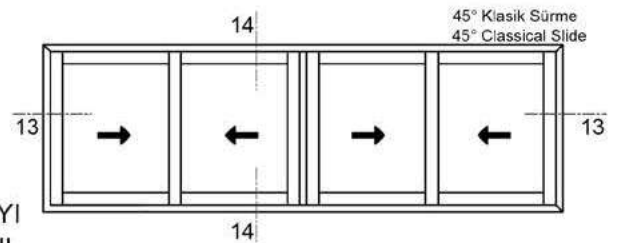
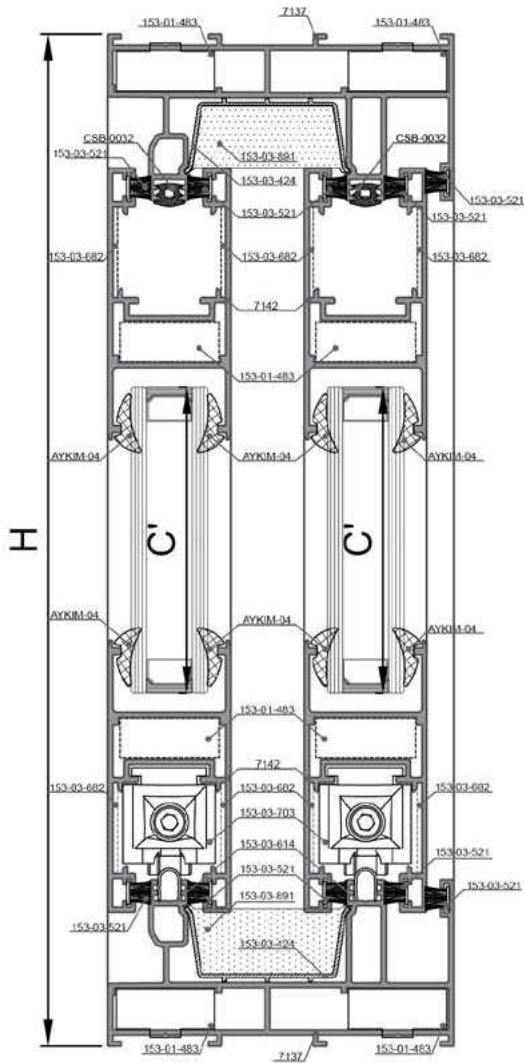
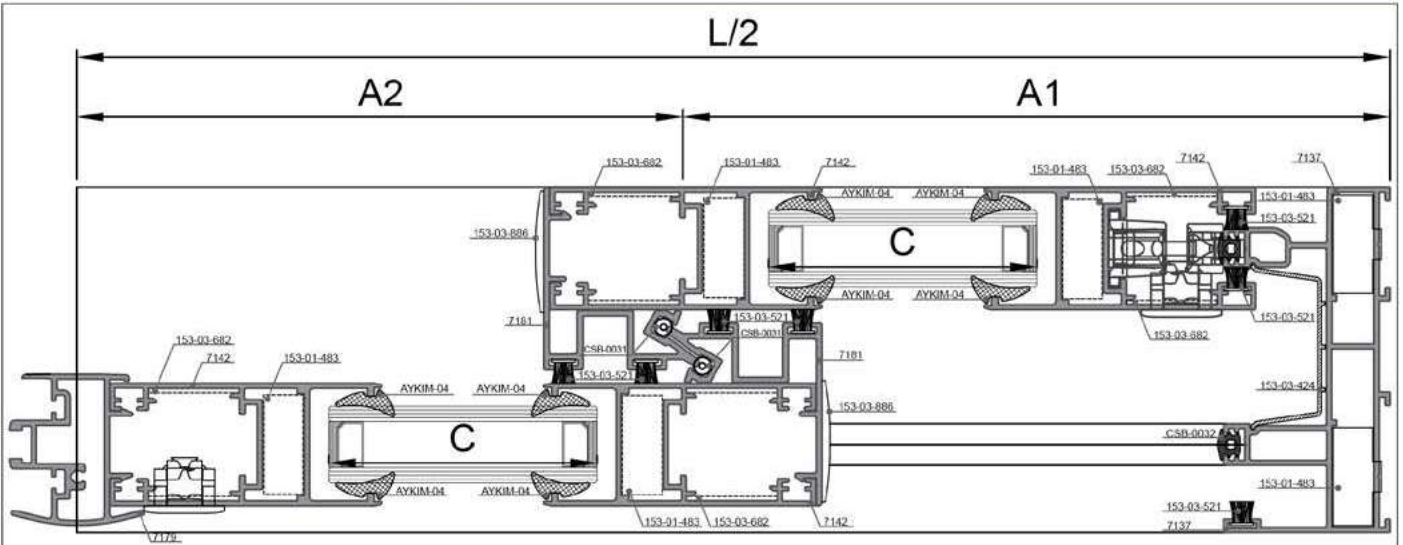
 14-14 DETAYI
 DETAIL

Kesim ölçüsü - cam ölçüsü vb. sorumluluğu tarafımıza ait değildir.

Çizimler 1/2 ölçeklidir.

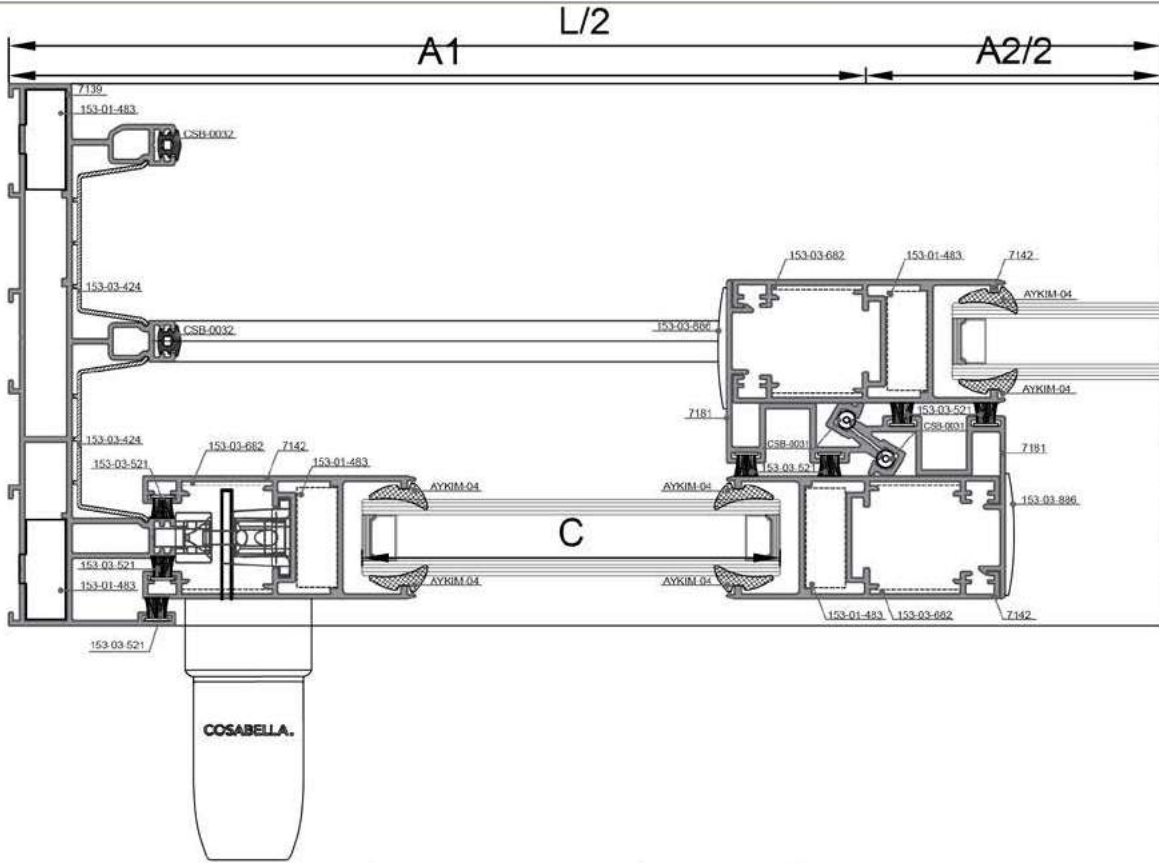

	Kasa Genişlik Frame Width	7139		2 Ad. 2 Pcs.	L
	Kasa Yükseklik Frame Height	7139		2 Ad. 2 Pcs.	H
	Kanat Genişlik Sash Width	7142		6 Ad. 6 Pcs.	A1+6,16
	Kanat Yükseklik Sash Height	7142		6 Ad. 6 Pcs.	H-70
	Kenet Adaptör Yükseklik Adapter Height	7181		4 Ad. 4 Pcs.	H-70
	Kanat Cam Genişlik Glazing Sash Width			1 Ad. 1 Pcs.	A1-141
	Kanat Cam Yükseklik Glazing Sash Height			1 Ad. 1 Pcs.	H-217

	153-01-483 Vidalı Köşe Bağ Takozu Screwed Corner Cleat	20 Ad. 20 Pcs.		153-03-614 Paslanmaz Çelik Ray Stainless Steel Rail Track	L:75,8 mm. 3 Ad./Pcs.
	153-03-891 Kasa Alt & Üst Tozluk Top & Bottom Frame Sealing	2 Tkm. 2 Set.		153-03-703 Ayarlı Rulman Adjustable Roller	6 Ad. 6 Pcs.
	153-03-886 Adaptör Kapığı Alt & Üst Adapter Cap Bottom & Top	4 Tkm. 4 Set.		153-03-682 Kanat Köşe Gönye Alignment Square	24 Ad. 24 Pcs.
	153-03-408 Stoplama Stoppage	4 Ad. 4 Pcs.		153-03-521 67-650'li Kumaş Fınlı Kıl Fıllı Brush Pile Seal	10H+8L
	153-03-424 Kanal "U" Plastik Plastic Cover For Frame	L:34 mm. 2 Ad./Pcs. H:34 mm. 2 Ad./Pcs.		CSB-0032 Ray Kapama Contası Gasket For Frame Rails	3L+6H
	153-03-888 Sallantı Engelleyici Shake Reducer	4 Ad. 4 Pcs.		AYKIM-04 Glazing Wedge Gasket (Cam Tercihi Göre) (Optional Glass Size)	12C+12C'

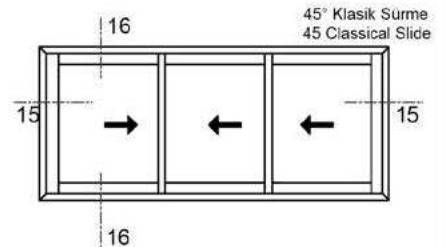

Kesim ölçüsü - cam ölçüsü vb. sorumluluğu tarafımıza ait değildir.

Çizimler 1/2 ölçeklidir.

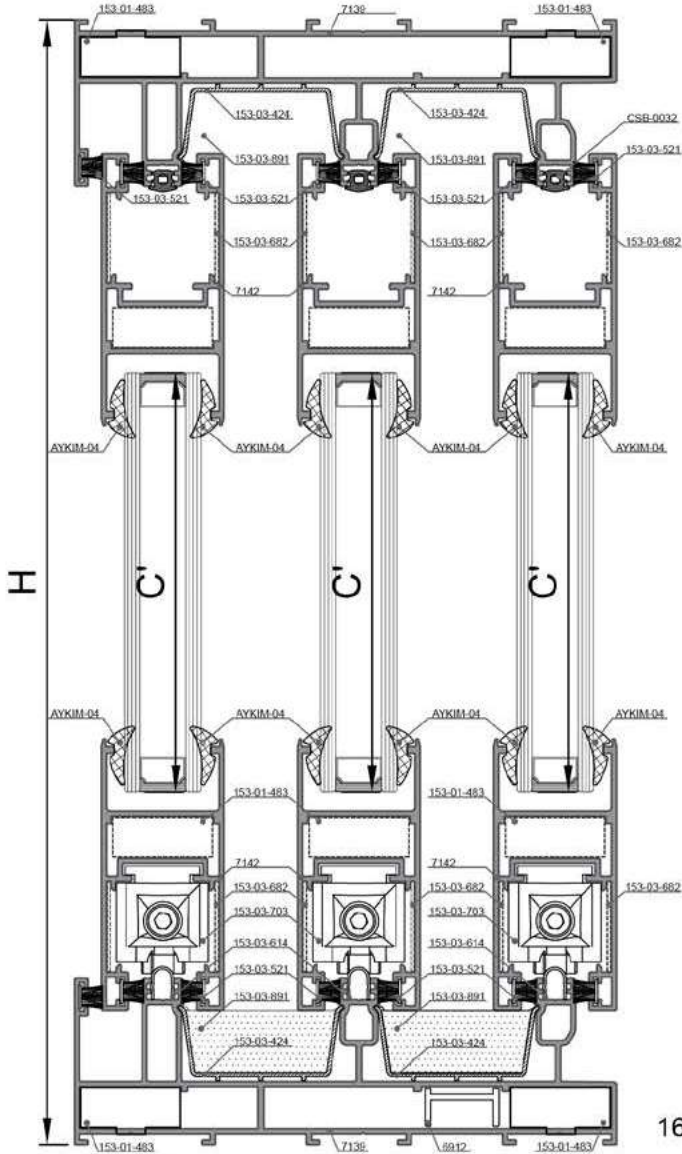
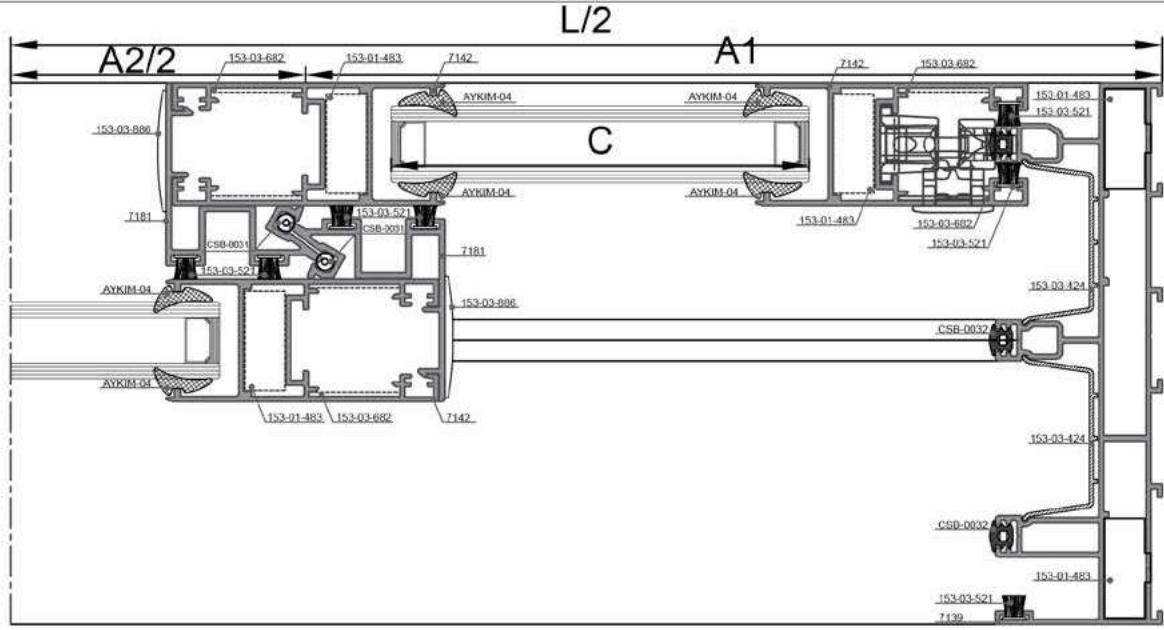

 15-15 DETAYI
 DETAIL

 16-16 DETAYI
 DETAIL

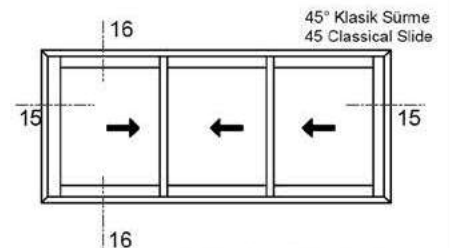
Kesim ölçüsü - cam ölçüsü vb. sorumluluğu tarafımıza ait değildir.

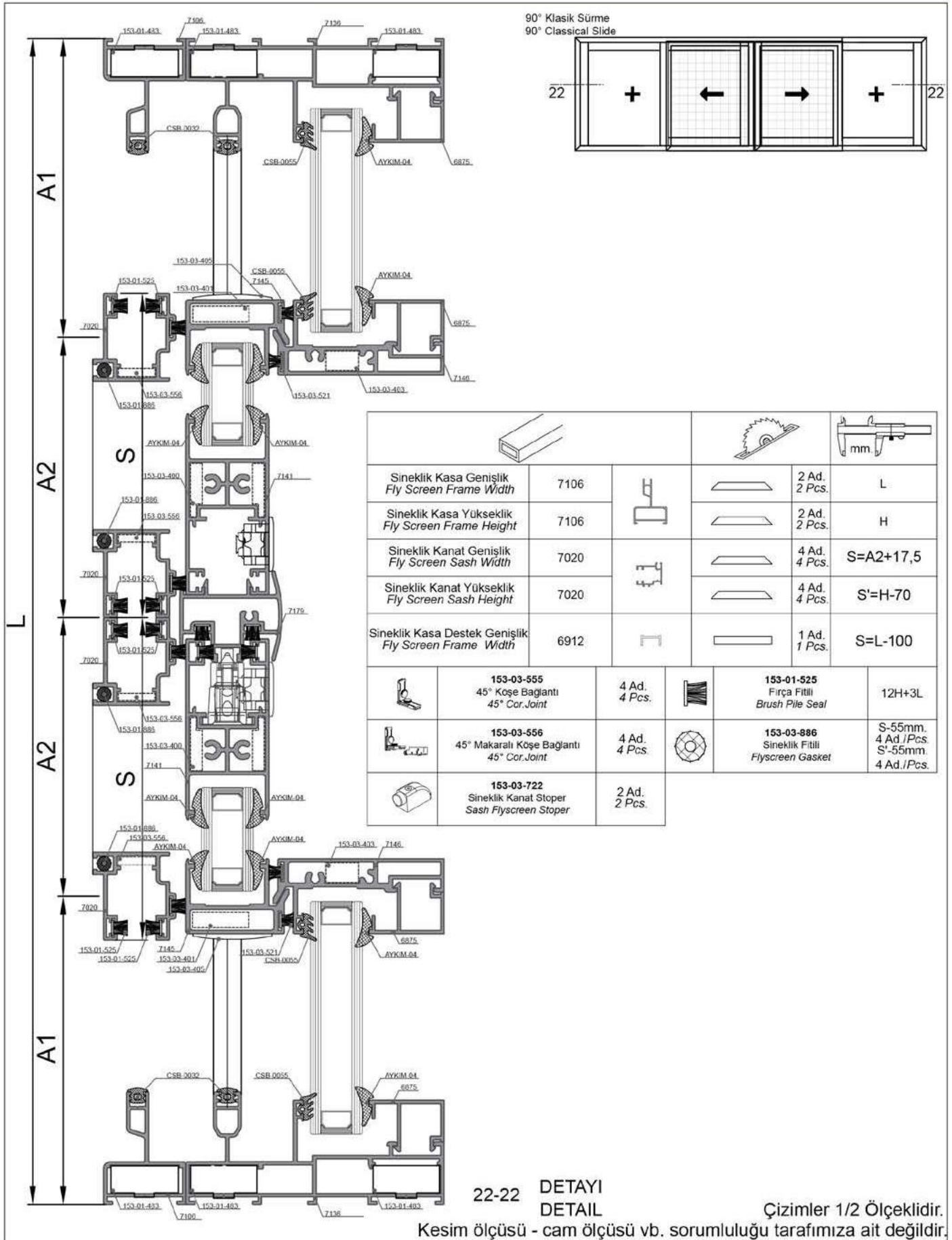

Çizimler 1/2 ölçeklidir.



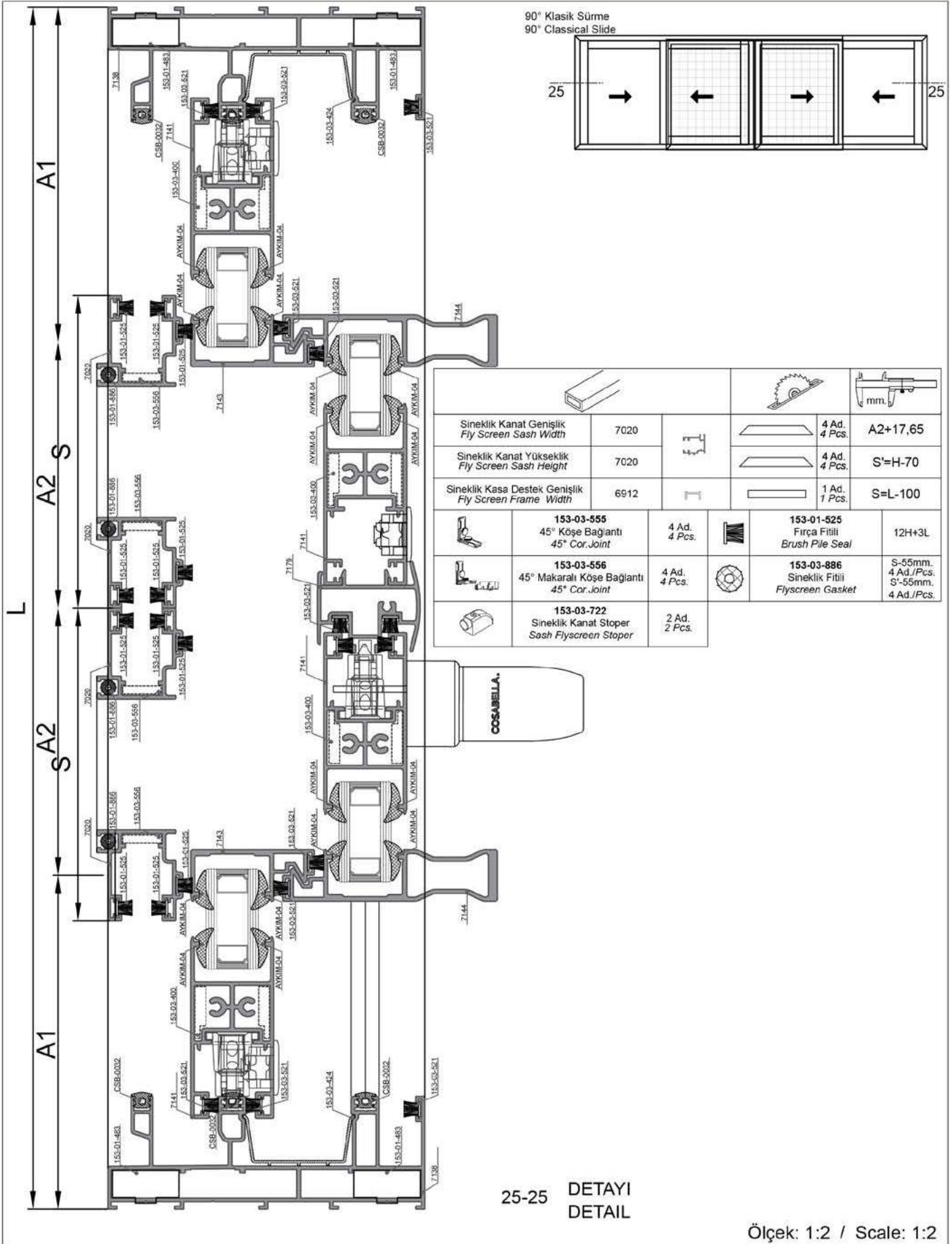

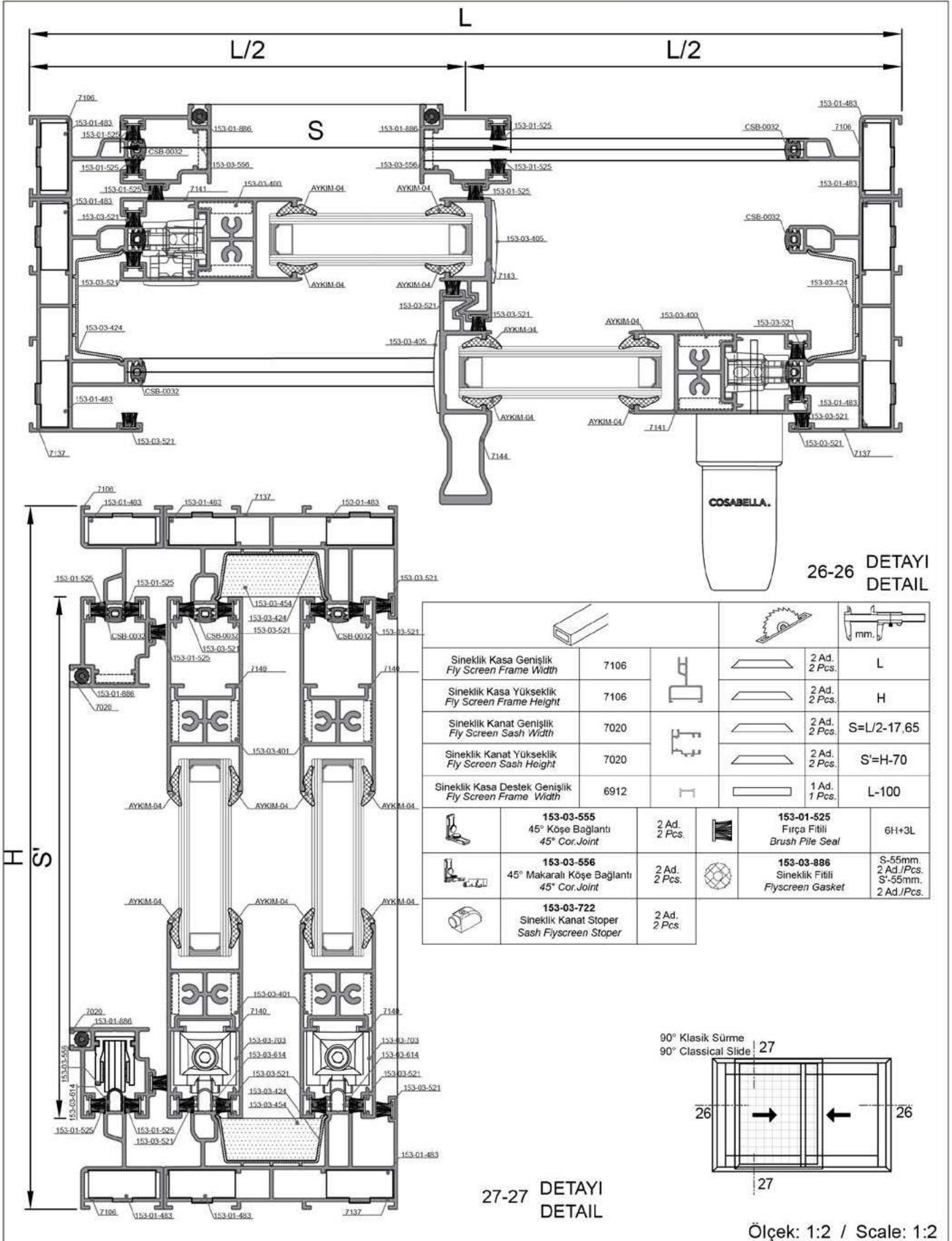

90° Klasik Sürme
90° Classical Slide

				mm.
Sineklik Kasa Genişlik Fly Screen Frame Width	7106			2 Ad. 2 Pcs. L
Sineklik Kasa Yükseklik Fly Screen Frame Height	7106			2 Ad. 2 Pcs. H
Sineklik Kanat Genişlik Fly Screen Sash Width	7020			4 Ad. 4 Pcs. S=A2+17
Sineklik Kanat Yükseklik Fly Screen Sash Height	7020			4 Ad. 4 Pcs. S'=H-70
Sineklik Kasa Destek Genişlik Fly Screen Frame Width	6912			1 Ad. 1 Pcs. S=L-100

	153-03-555 45° Köşe Bağlantı 45° Cor.Joint	4 Ad. 4 Pcs.
	153-03-556 45° Makaralı Köşe Bağlantı 45° Cor.Joint	4 Ad. 4 Pcs.
	153-03-722 Sineklik Kanat Stoper Sash Flyscreen Stoper	2 Ad. 2 Pcs.
	153-01-525 Fırça Fitolü Brush Pile Seal	12H+3L
	153-03-886 Sineklik Fitilli Flyscreen Gasket	S-55mm. 4 Ad./Pcs. S'-55mm. 4 Ad./Pcs.

30-30 DETAYI
DETAIL



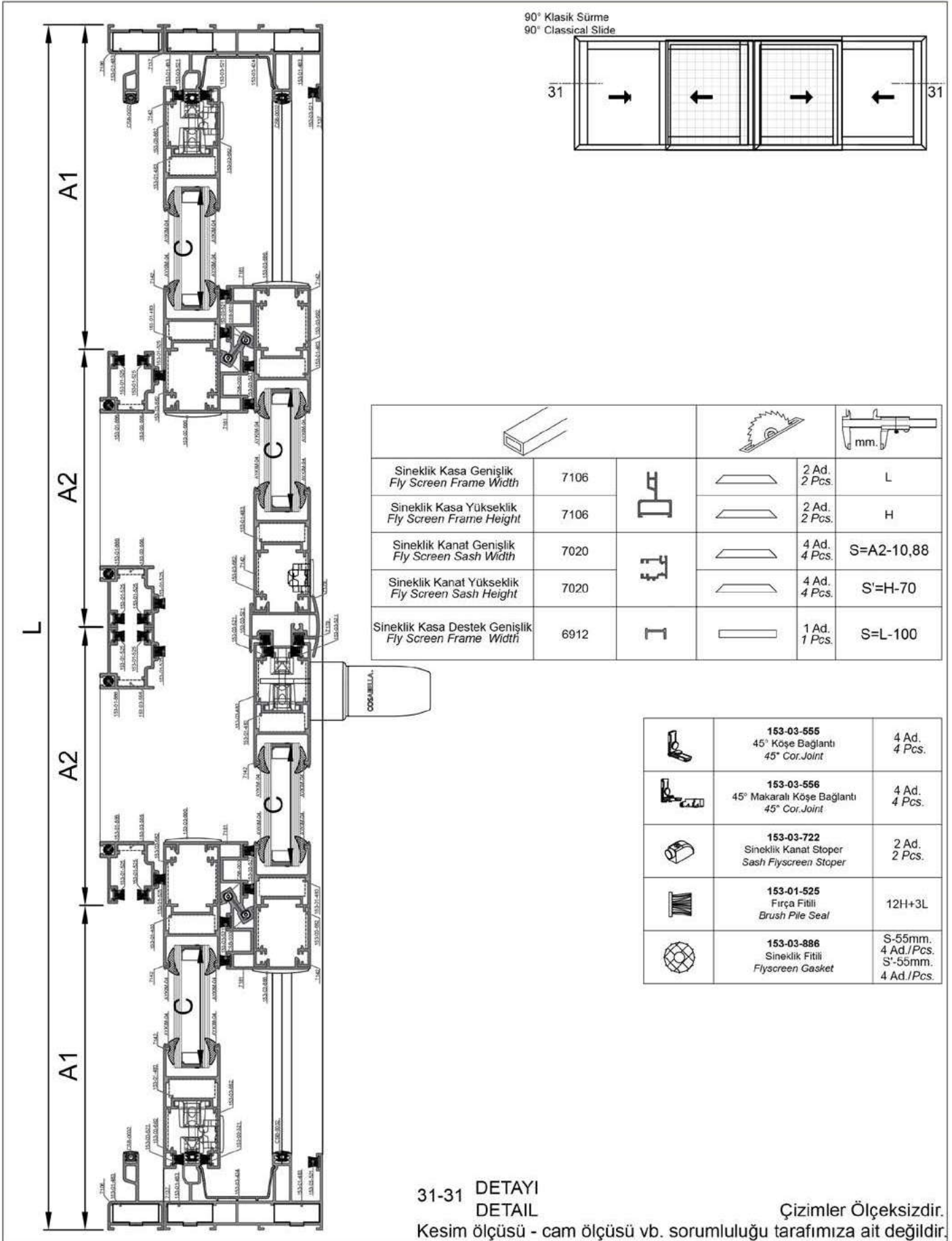





Ölçek: 1:2 / Scale: 1:2

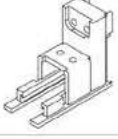

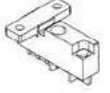

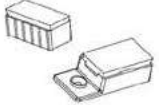
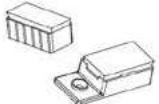
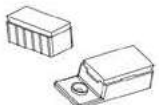







Aksesuarlar / Accessories

SD22

COSABELLA®
innovative aluminum solutions







Ürün Çizimi Drawing	Ürün Kodu Product No	Ürün Adı Product Name	Kullanıldığı Profiller Profiles Used
	153-01-483	Kasa Bağlantı Takoğu 11/26 <i>Joint Corner</i>	7136 7138 7139 7137
	153-03-400	90° Geniş Köşe Bağlantı Takoğu <i>90° Wide Sash Cor.Joint</i>	7141 7140
	153-03-401	90° Dar Köşe Bağlantı Takoğu <i>90° Narrow Sash Cor.Joint</i>	7145 7140
	153-03-402	90° Dar Köşe Bağlantı Takoğu <i>90° Narrow Sash Cor.Joint</i>	7143 ve 7144 7140
	153-03-403	90° Dar Köşe Bağlantı Takoğu <i>90° Narrow Sash Cor.Joint</i>	7146 7136
	153-03-682	Kanat Köşe Gönye <i>Alignment Square</i>	-
	153-03-504	Kasa Alt & Üst Tozluk <i>Central Top & Bottom Sealing</i>	
	153-03-454	Kasa Alt & Üst Tozluk <i>Central Top & Bottom Sealing</i>	-
	153-03-891	45° Kasa Alt & Üst Tozluk <i>Central Top & Bottom Sealing</i>	-
	153-03-405	Adaptör Kapağı Alt & Üst <i>Adapter Cap Bottom & Top</i>	-
	153-03-886	45° Kanat Adaptör Kapağı Alt & Üst <i>Adapter Cap Bottom & Top</i>	-
	153-03-406	SD-33 Kenetli Alt-Üst Kulp Kapağı <i>SD-33 Sash Bottom & Top Cap</i>	-

Ürün Çizimi Drawing	Ürün Kodu Product No	Ürün Adı Product Name	Kullanıldığı Profiller Profiles Used
	153-03-407	Cosabella SD-32 4'lü Kanat Adaptör Kapağı <i>Cosabella S32-T 4 Winged Lid</i>	-
	153-03-408	Stoplama <i>Stoppage</i>	-
	153-03-888	Sallantı Engelleyici Shake Reducer	-
	153-03-424	Kanal "U" Plastiği <i>U Duct Plastic</i>	-
	153-03-703	Ayarlı Rulman <i>Adjustable Roller</i>	-
	153-03-614	Paslanmaz Çelik Ray Stainless Steel Rail Track	-
	153-03-412	Adaptör Kenetleme Klipsi <i>Plastic Lock Clips</i>	-
	153-03-409	Sabitleme Takoza <i>Fixing Wedge</i>	-
	153-01-410	Sabitleme Aparatı <i>Fixing Device</i>	-
	153-01-356	POLYAMİD TİJ POLYAMIDE TIJ	-
	153-03-423	Tijli Sistem Karşılığı EQUIPMENT FOR TIJI SYS.	-

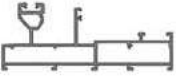
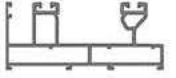
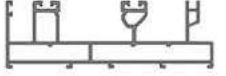
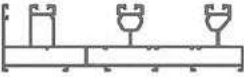
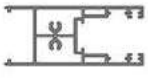
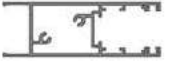
Ürün Çizimi Drawing	Ürün Kodu Product No	Ürün Adı Product Name	Kullanıldığı Profiller Profiles Used
	153-03-973	COSABELLA Kilitleme Parçası COSABELLA Locking Part	-
	153-03-986	Stac Maçalı Kol Spades Handle 986-Siyah 986-Black	-
	153-03-479	Stac Kıvrık Eksenel Kol Sol Spades Handle 478-Siyah 478-Black	-
	153-03-478	Stac Kıvrık Eksenel Kol Sağ Spades Handle 479-Siyah 479-Black	-
	153-03-317	Tijli Gömme Kilit Pimi Tij Mixed Lock Pin	-
	153-03-801 153-03-812 153-03-814	Tijli Gömme Kilit Karşılığı 801 renkil, 812 eloksal, 814 beyaz 814 color, 812 silver, 814 white	-
	153-03-802 153-03-813 153-03-815	Tijli Gömme Kilit Mixed Lock With Hinge 802 renkil, 813 eloksal, 815 beyaz 802 color, 813 silver, 815 white	-
	153-02-789	Tahliye Tapası Drain Plug	-
	153-03-722	Sineklik Kanat Stoper Sash Flyscreen Stoper	-
	153-03-555	45° Köşe Bağlantı 45° Corner Joint	-
	153-03-556	45° Makaralı Köşe Bağlantı 45° Corner Joint	-
	153-03-521	67-650'lik Kumaş Finli Kıl Fitol Brush Pile Seal	-

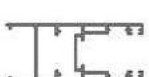
SD22
SD23
SD32
SD33
SD35
WD42
WD52
FS72

SD23

Profil Profile	Profil Kodu Profile Nr	Ağırlık (kg/m.) Weight (kg/m.)	X mm.	Y mm.	Jx cm ⁴	Jy cm ⁴
	7152 Tekli Kasa Profili Frame Profile	1,502kg/mt	111,1 mm	43,42 mm	64,02	7,55
	7153 Sürme Kasa Profili Frame Profile	1,637kg/mt	102,2 mm	43,5 mm	63,43	11,34
	7155 Sineklikli Kasa Profili Frame Profile	2,079kg/mt	134,48 mm	43,5 mm	132,11	14,13
	7154 Üçlü Kasa Profili Frame Profile	2,391kg/mt	157,04 mm	43,5 mm	212,02	16,55
	7157 Kilit Kanat Profili Sash Profile	1,559kg/mt	90 mm	38 mm	31,49	12,03
	7156 Yatay Kanat Pr. Sash Pr.	1,537kg/mt	102,5 mm	35 mm	44,20	11,40
	7182 Adaptör Profili Adapter Profile	0,674 kg/m	49,72 mm	53,7 mm	9,48	2,66
	7158 45° Kanat Profili Sash Profile	1,374kg/mt	89,5 mm	38 mm	29,51	12,41
	7159 Kenet Kanat Pr. Sash Pr.	0,826kg/mt	53,2 mm	37 mm	10,40	2,86
	7160 Takviyeli Kenet Kanat Profili Sash Profile	1,421kg/mt	95 mm	37 mm	52,46	7,47
	7161 Kenet Kanat Pr. Sash Pr.	0,729kg/mt	45,74 mm	37 mm	7,16	2,7

Profil Profile	Profil Kodu Profile Nr	Ağırlık (kg/m.) Weight (kg/m.)	X mm.	Y mm.	Jx cm ⁴	Jy cm ⁴
	7162 Orta Kayıt Profili Middle Transom Profile	1,015kg/mt	71,34 mm	37 mm	18,56	2,59
	7180 Kilitleme Profili Adapter Profile	0,803kg/mt	35,27 mm	45,53 mm	6,29	2,47
	6912 H Destek Profili H Support Profile	0,148 kg/m	19,33 mm	9,88 mm	-	-
	6875 Cam Çıta Profili Glazing Bread Pr.	0,271 kg/m	29 mm	19,86 mm	-	-
	6865 Adaptör Profili Adapter Profile	0,541kg/m	69,6 mm	23,6 mm	13,09	0,84
	6872 Adaptör Profili Adapter Profile	0,467kg/m	69,6 mm	18,6 mm	9,32	0,38
	7106 Sineklik Profili Fly Screen Profile	0,521 kg/m	31,8 mm	43,5 mm	-	-
	7020 Sineklik Profili Fly Screen Profile	0,532 kg/m	33,15 mm	35 mm	-	-

Sürme Tekli Kasa Profili - Sliding Frame Profile

7152

1,502 kg/mt

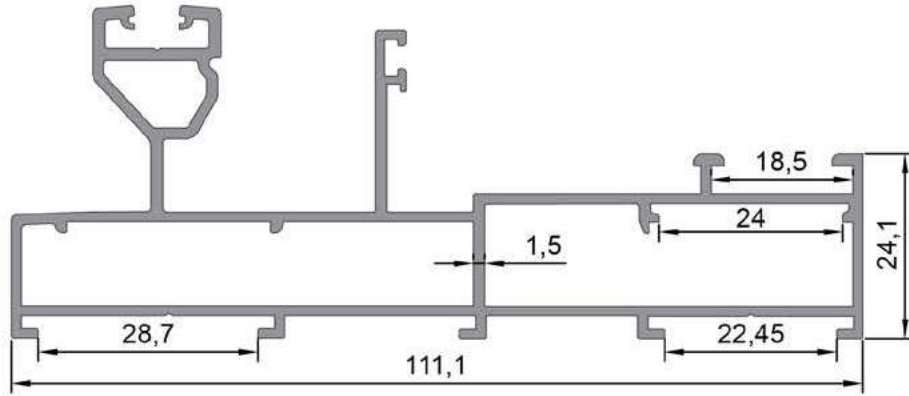
7152

Kod/Code	Et Kalın./Wall Thk.	Ürün Adı / Prod. Name	Ağırlığı / Weight	Köşe Takozu / C. Cleat
7152	1,5 mm	Tekli Kasa Pr. / Single Frame Profile	1,502 kg/mt	-

Sürme Kasa Profili - Sliding Frame Profile

7153

1,637 kg/mt

Kod	Et Kalın.	Ürün Adı	Ağırlığı	Köşe Takozu
				-

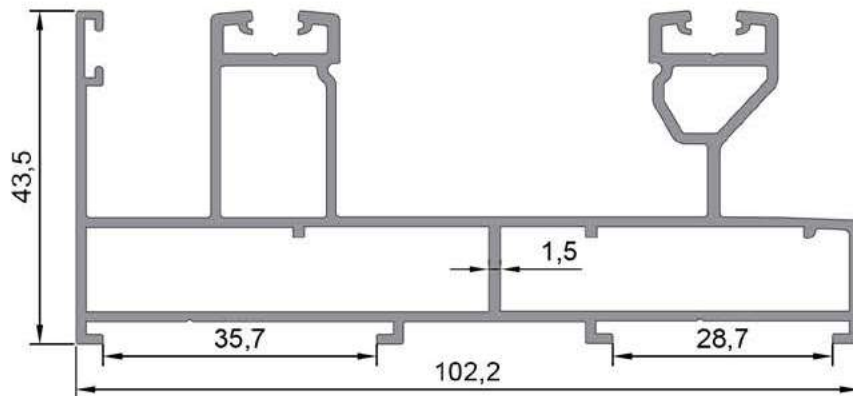

7153

Kod/Code	Et Kalın./Wall Thk.	Ürün Adı / Prod. Name	Ağırlığı / Weight	Köşe Takozu / C. Cleat
7153	1,5 mm	Sürme Kasa Pr. / Sliding Frame Pr.	1,637 kg/mt	-

Sineklikli Kasa Profili - Sliding Frame Profile

7155

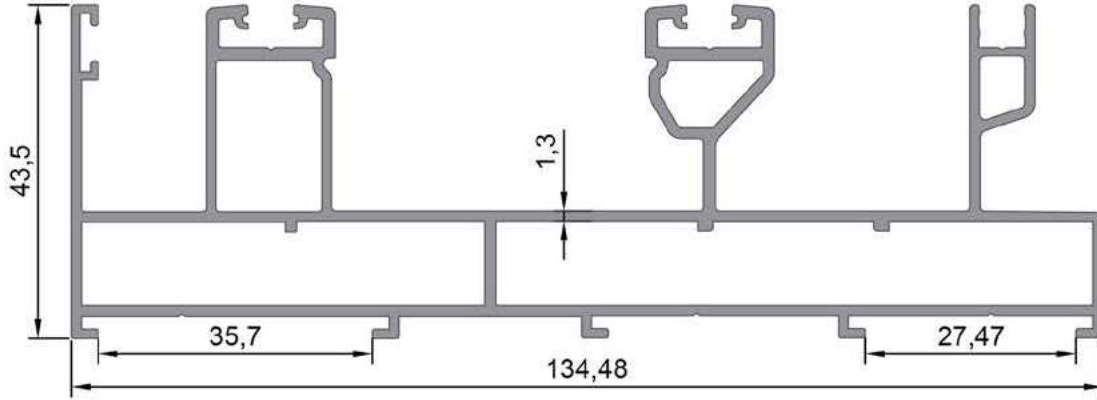
2,079 kg/mt



7155

Kod/Code	Et Kalın./Wall Thk.	Ürün Adı / Prod. Name	Ağırlığı / Weight	Köşe Takozu / C. Cleat
7155	1,3 mm	Sineklikli Kasa Pr./Fly Screen Frame Pr.	2,079 kg/mt	-

Üçlü Sürme Kasa Profili - Sliding Frame Profile

7154

2,391 kg/mt

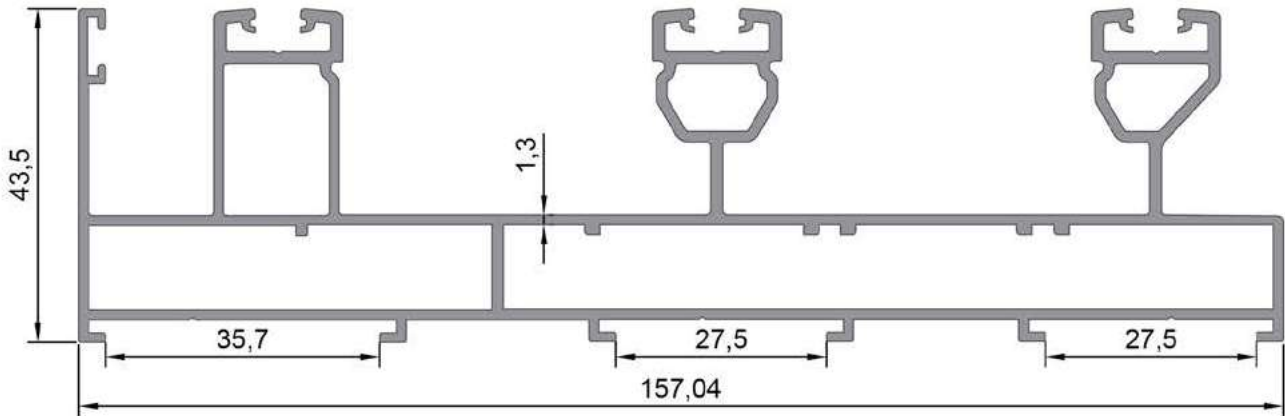

7154

Kod/Code	Et Kalın./Wall Thk.	Ürün Adı / Prod. Name	Ağırlığı / Weight	Köşe Takozu / C. Cleat
7154	1,3 mm	Üçlü Kasa Pr. / Triple Frame Pr.	2,391 kg/mt	-

90° Kilit Kanat Profili - Sash Profile

7157

1,559 kg/mt

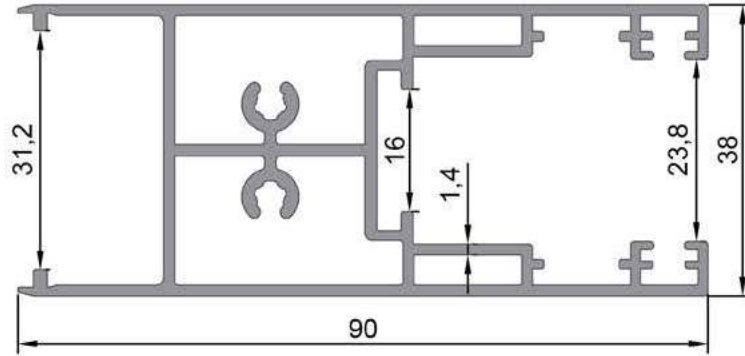

7157

Kod/Code	Et Kalın./Wall Thk.	Ürün Adı / Prod. Name	Ağırlığı / Weight	Köşe Takozu / C. Cleat
7157	1,4 mm	Kilit Kanat Pr. / Locking Sash Profile	1,559 kg/mt	-

Yatay Kanat Profili - Horizontal Sash Profile

7156

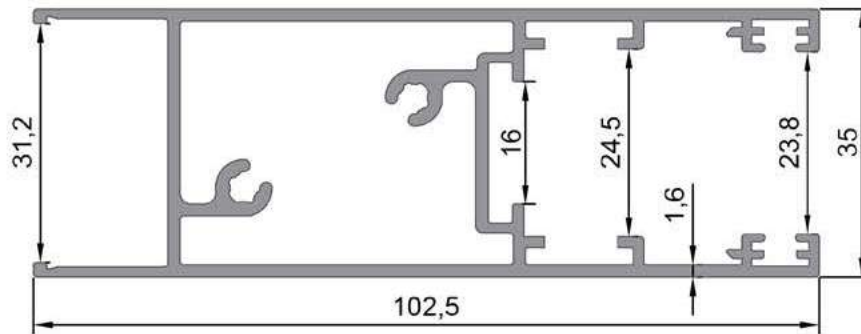
1,537 kg/mt



7156

Kod/Code	Et Kalın./Wall Thk.	Ürün Adı / Prod. Name	Ağırlığı / Weight	Köşe Takozu / C. Cleat
7156	1,6 mm	Yatay Kanat Pr. / Horizontal Sash Pr.	1,537 kg/mt	-

Kenet Profili - Sash Profile

7182

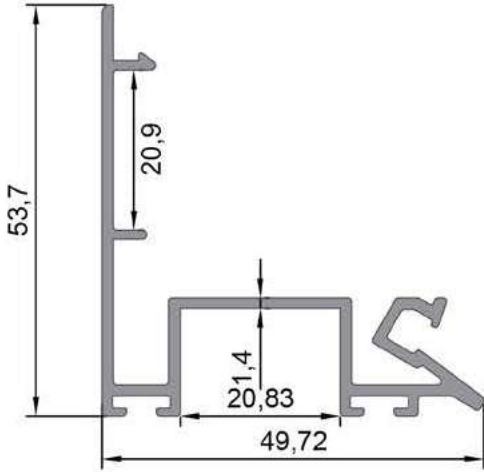
0,674 kg/mt



7182

45° Kanat Profili - Sash Profile

7158

1,374 kg/mt

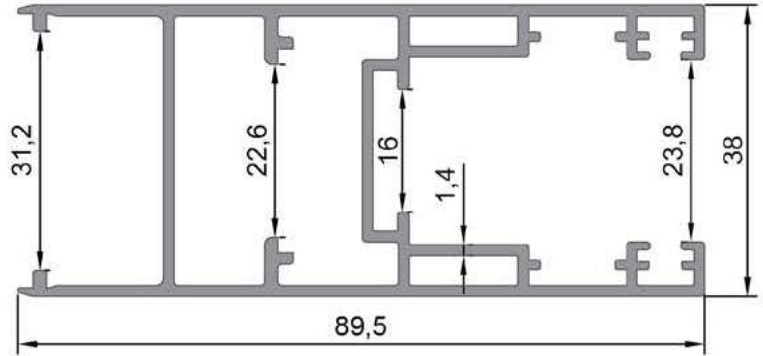

7158

Kod/Code	Et Kalın./Wall Thk.	Ürün Adı / Prod. Name	Ağırlığı / Weight	Köşe Takozu / C. Cleat
7182	1,4 mm	Kenet Pr. / Interlock Profile	0,674 kg/mt	-
7158	1,4 mm	45° Kanat Pr. / 45° Sash Profile	1,374 kg/mt	-

Takviyesiz Kenet Kanat Profili - Sash Profile

7159

0,826 kg/mt

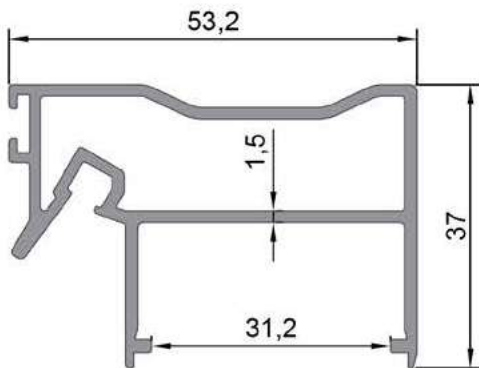

7159

Takviyeli Kenet Kanat Profili - Sash Profile

7160

1,421 kg/mt

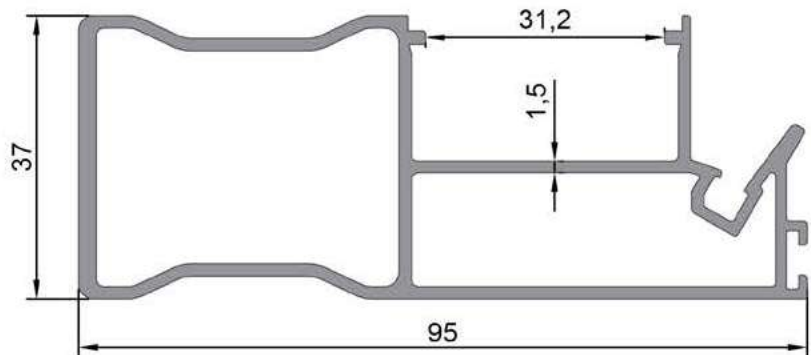

7160

Kod/Code	Et Kalın./Wall Thk.	Ürün Adı / Prod. Name	Ağırlığı / Weight	Köşe Takozu / C. Cleat
7159	1,5 mm	Takviyesiz Kanat / Non-Reinforced Sash Pr.	0,826 kg/mt	-
7160	1,5 mm	Takviyeli Kanat / Reinforced Sash Profile	1,421 kg/mt	-

Kenet Kanat Profili - Sash Profili

7161

0,729 kg/mt

Tekli Kasa Orta Kayıt Profili - Middle Transom Profile

7162

1,015 kg/mt

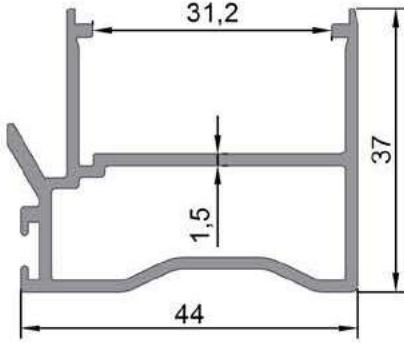
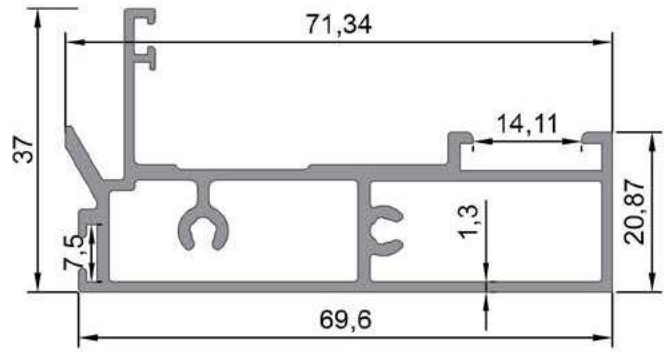
7161

7162

Kod/Code	Et Kalın./Wall Thk.	Ürün Adı / Prod. Name	Ağırlığı / Weight	Köşe Takozu / C. Cleat
7161	1,5 mm	Kenet Kanat Pr. / Interlock Sash Profile	0,729 kg/mt	-
7162	1,3 mm	Orta Kayıt Pr. / Middle Transom Profile	1,015 kg/mt	-

Orta Kilitleme Pr. - Center Locking Pr. H Destek Pr.- H Support Pr. Cam Çıta Pr. - Glazing Bead Pr.

7180

0,803 kg/mt

6912

0,148 kg/mt

6875

0,271 kg/mt

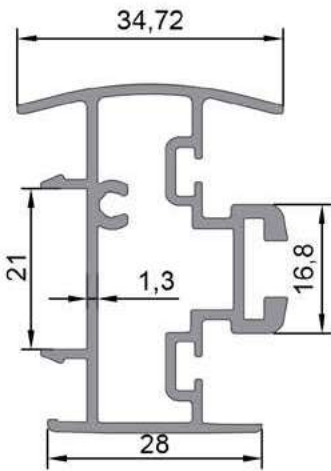
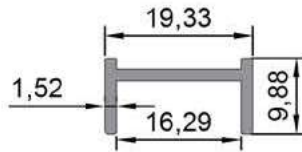
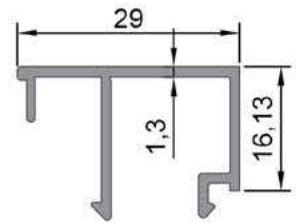
7180

6912

6875

Kod/Code	Et Kalın./Wall Thk.	Ürün Adı / Prod. Name	Ağırlığı / Weight	Köşe Takozu / C. Cleat
7180	1,3 mm	Orta Kilitleme Pr. / Center Locking Profile	0,803 kg/mt	-
6912	1,52mm	H Destek Pr. / H Support Profile	0,148 kg/mt	-
6875	1,3 mm	Cam Çıta / Glazing Bead Profile	0,271 kg/mt	-

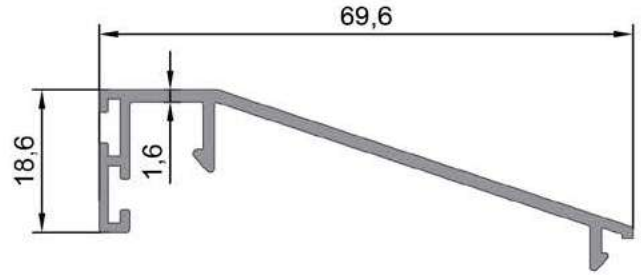
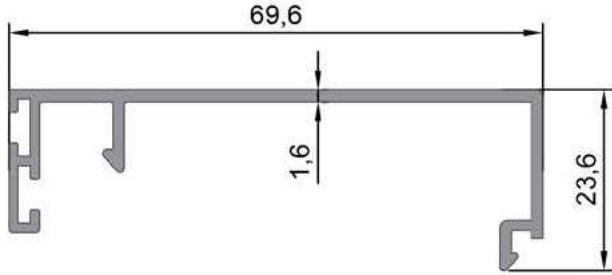
Tekli Kasa Adaptör Profili - Adapter Profile
6865
0,541 kg/m

Tekli Kasa Adaptör Profili - Adapter Profile
6872
0,467 kg/m



6865

6872

Kod/Code	Et Kalın./Wall Thk.	Ürün Adı / Prod. Name	Ağırlığı / Weight	Köşe Takozu / C. Cleat
6865	1,6 mm	Adaptör Pr. / Adapter Profile	0,541 kg/m	-
6872	1,6 mm	Adaptör Pr. / Adapter Profile	0,467 kg/m	-

Sineklik Kasa Profili-Fly Screen Frame Profile
7106
0,522 kg/m

Sineklik Kanat Profili-Fly Screen Profile
7020
0,532 kg/m

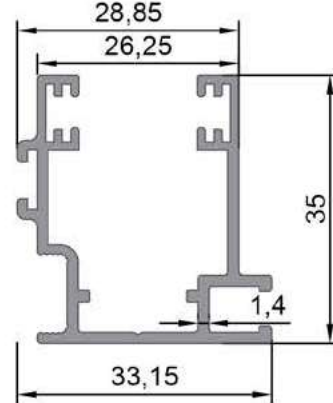
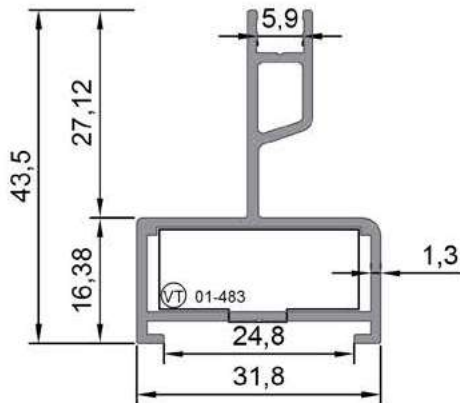

7106

7020

Kod/Code	Et Kalın./Wall Thk.	Ürün Adı / Prod. Name	Ağırlığı / Weight	Köşe Takozu / C. Cleat
7106	1,3 mm	Sineklik Kasa Pr. / Fly Screen Frame Pr.	0,522 kg/m	-
7020	1,4 mm	Sineklik Pr. / Fly Screen Profile	0,532 kg/m	-

90° Klasik Tek Ray Sürme

90° Classical Monorail Slide

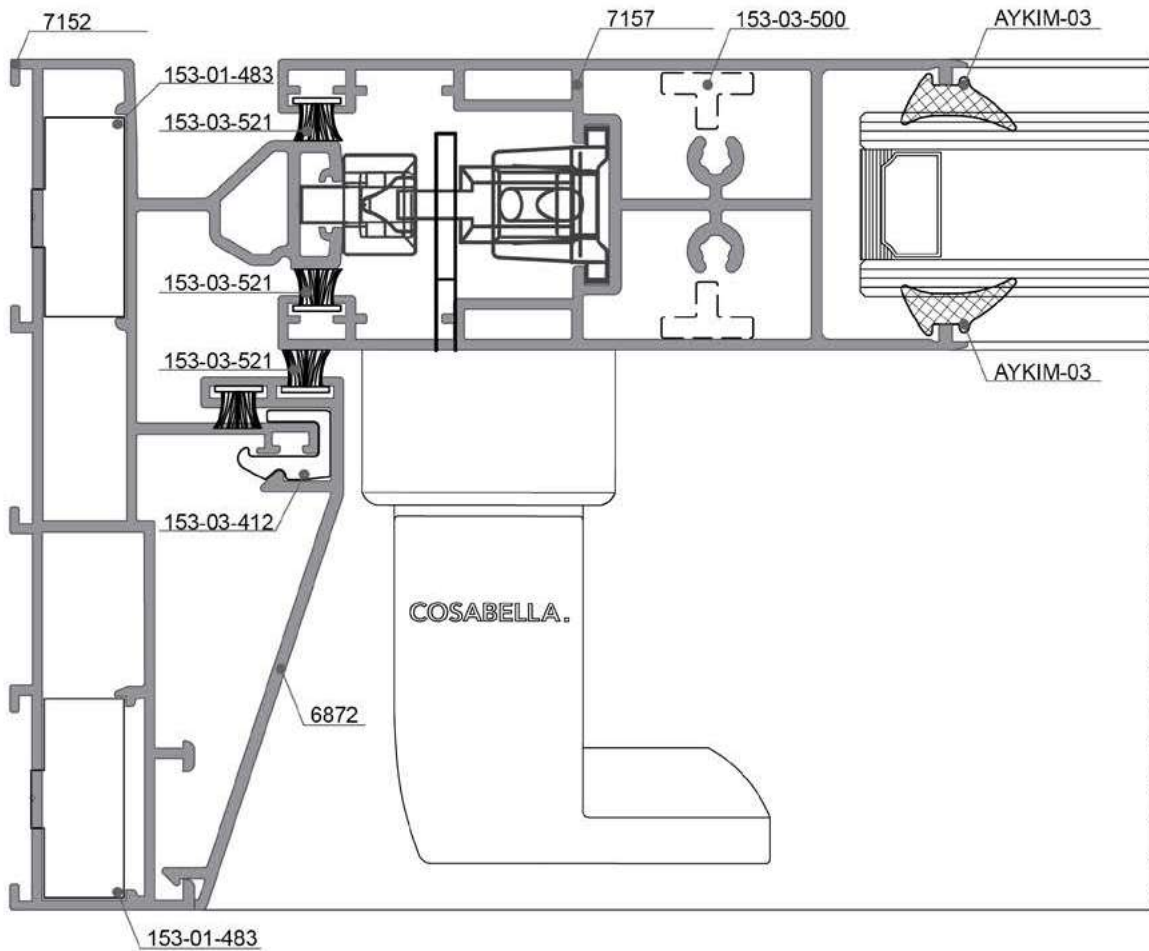
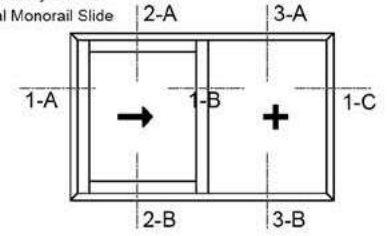
 1-A DETAYI
 DETAIL

Ölçek: 1:1 / Scale: 1:1

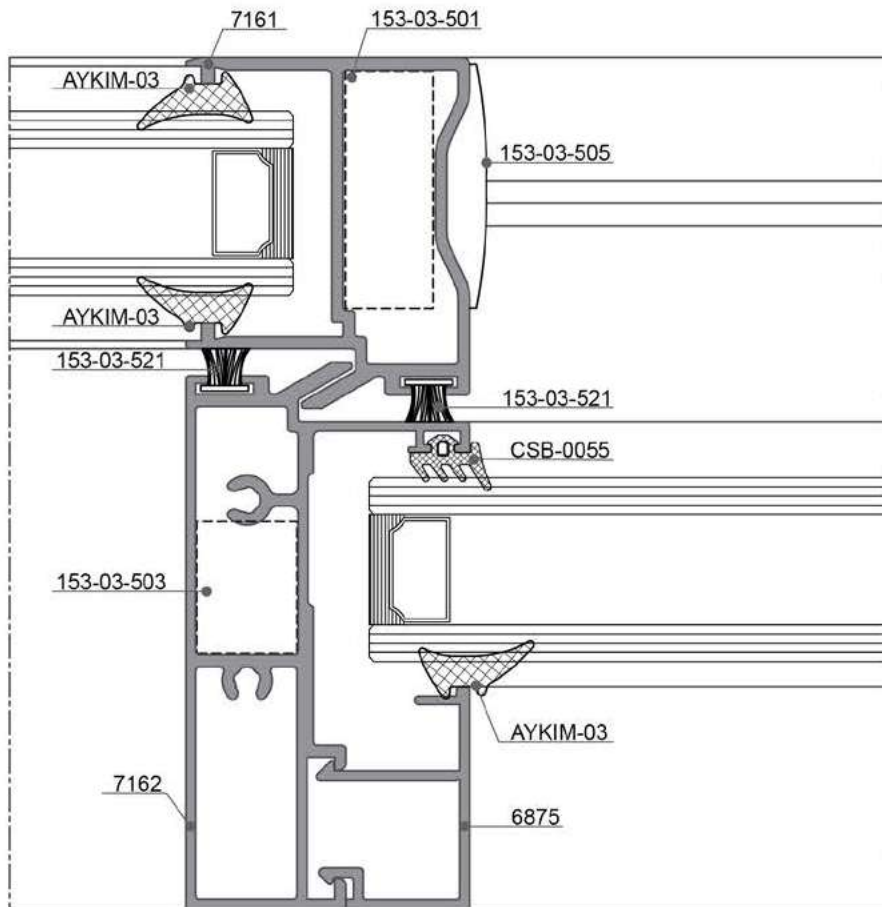
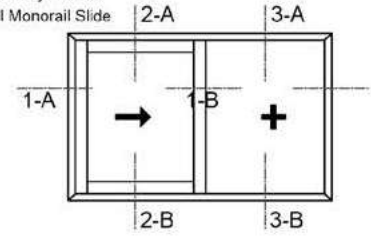
90° Klasik Tek Ray Sürme
90° Classical Monorail Slide1-B DETAYI
DETAIL

Ölçek: 1:1 / Scale: 1:1

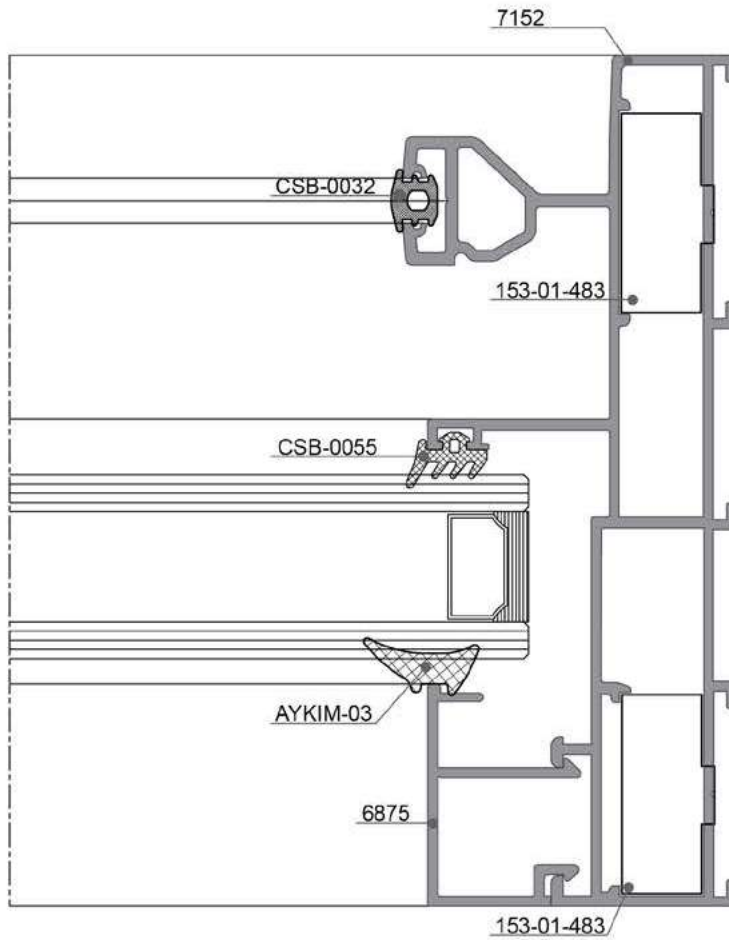
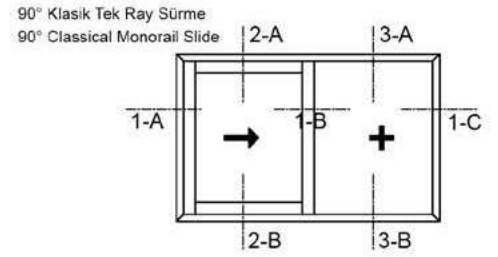
 1-C DETAYI
 DETAIL

Ölçek: 1:1 / Scale: 1:1

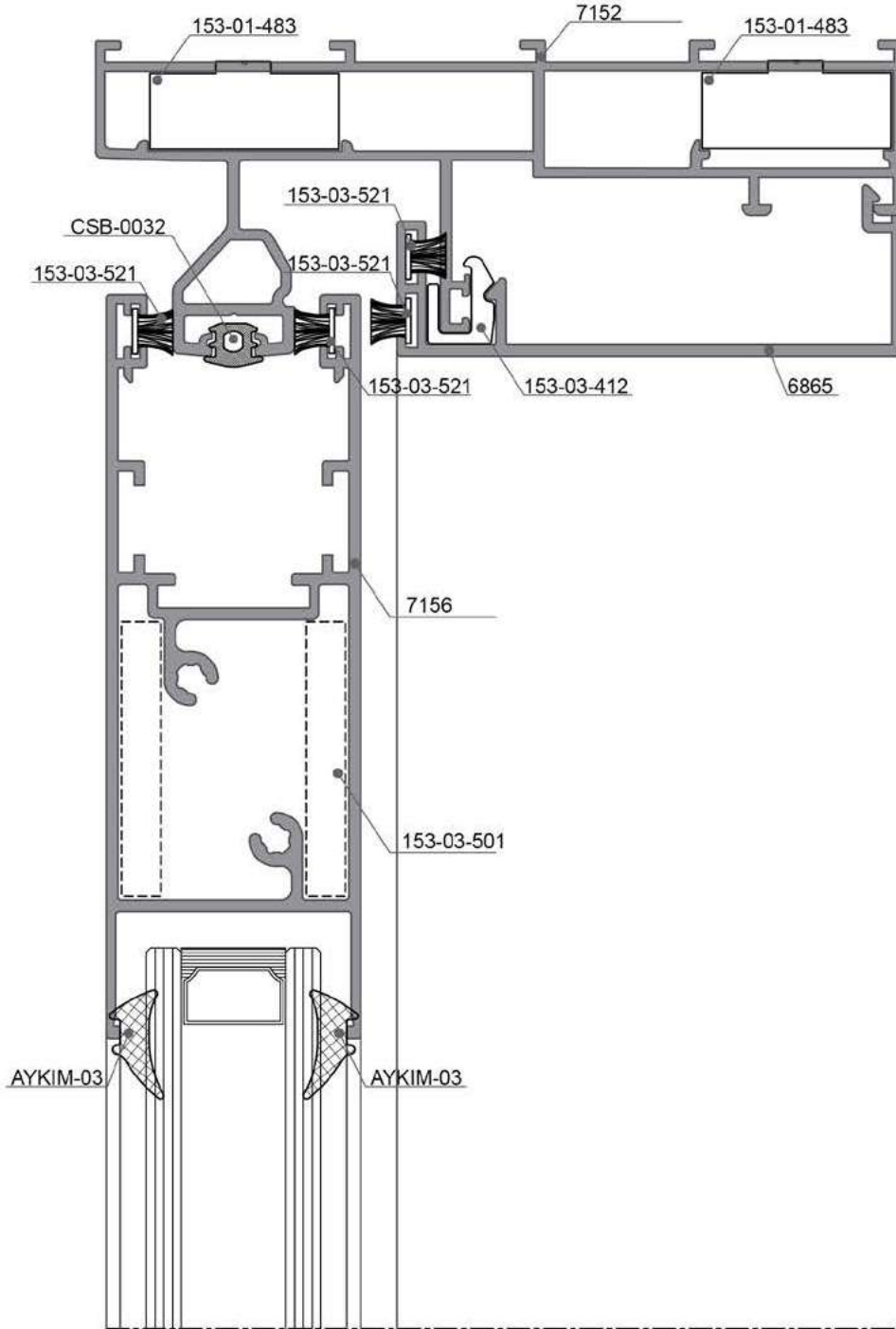
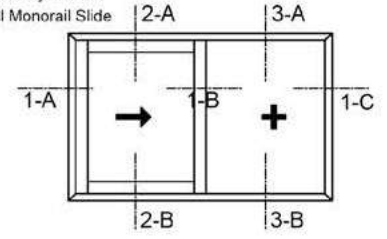
90° Klasik Tek Ray Sürme
90° Classical Monorail Slide2-A DETAYI
DETAIL

Ölçek: 1:1 / Scale: 1:1

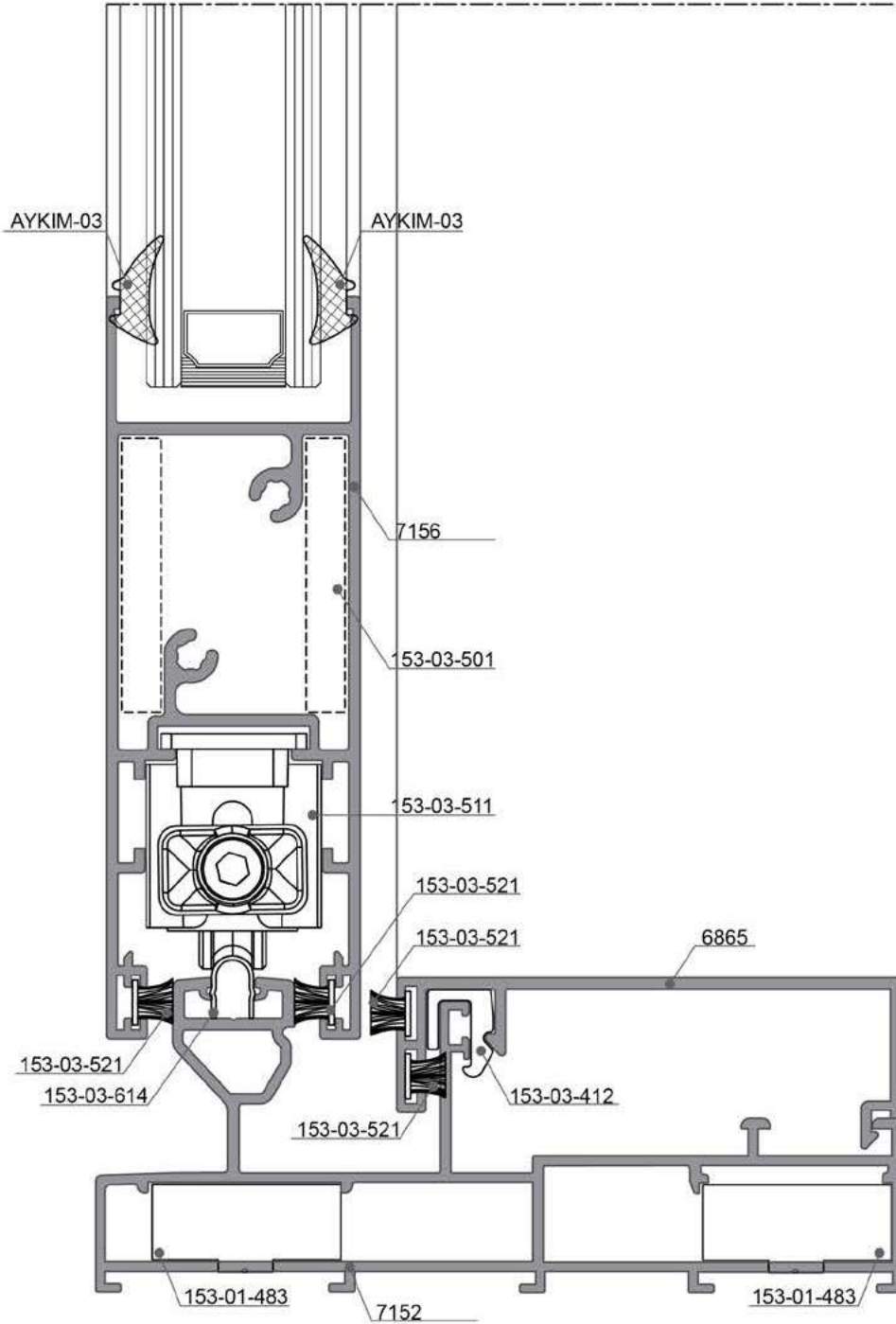
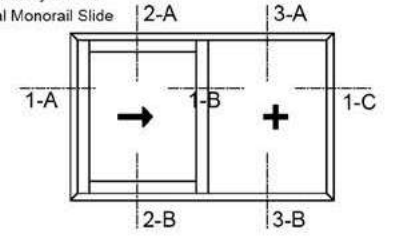
90° Klasik Tek Ray Sürme
 90° Classical Monorail Slide

 2-B
 DETAYI
 DETAIL

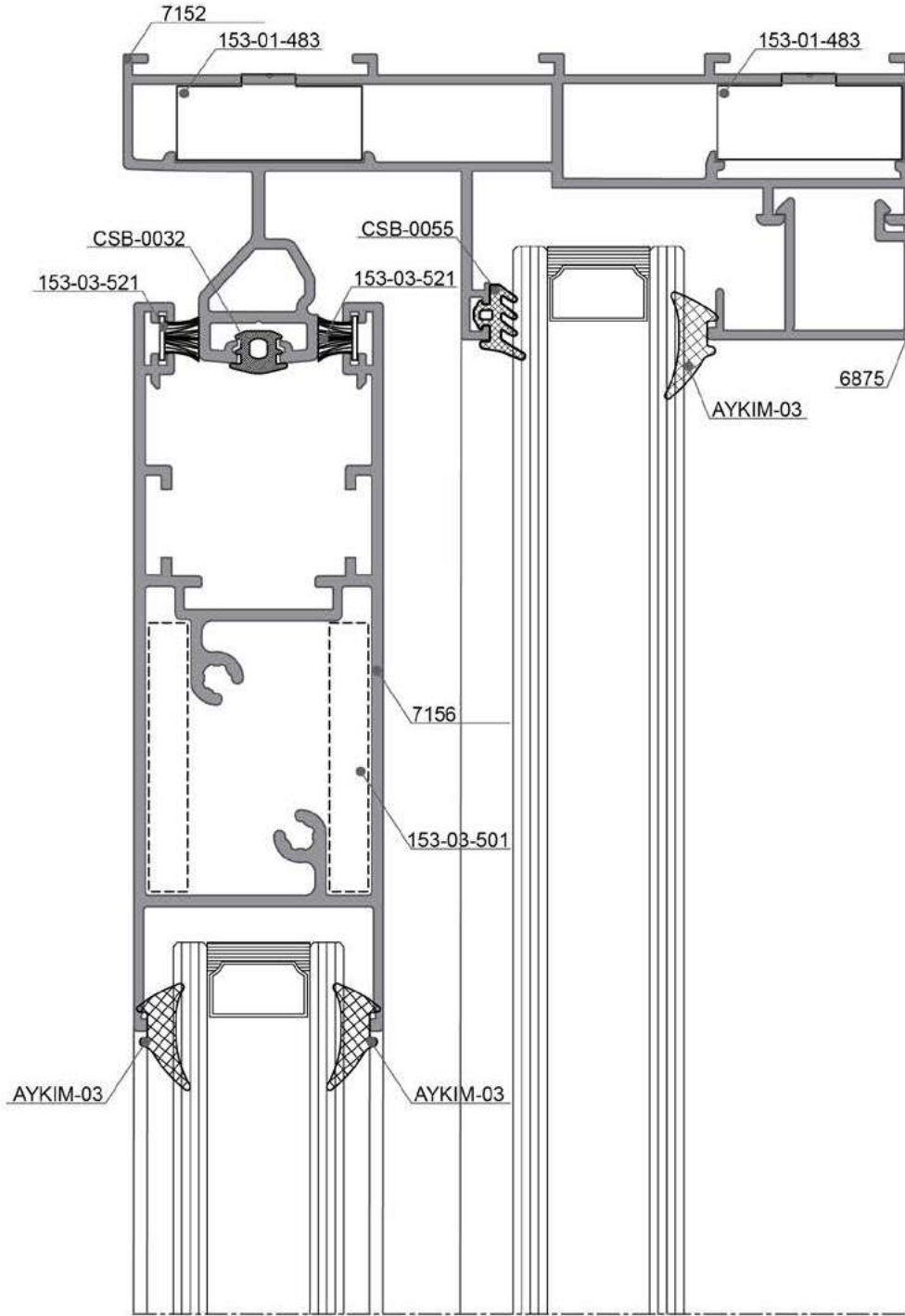
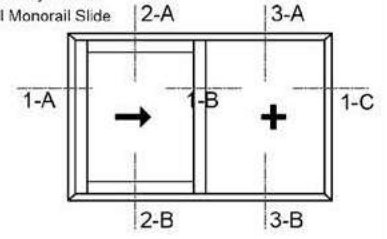
Ölçek: 1:1 / Scale: 1:1

90° Klasik Tek Ray Sürme
90° Classical Monorail Slide3-A DETAYI
DETAIL

Ölçek: 1:1 / Scale: 1:1

90° Klasik Tek Ray Sürme

90° Classical Monorail Slide

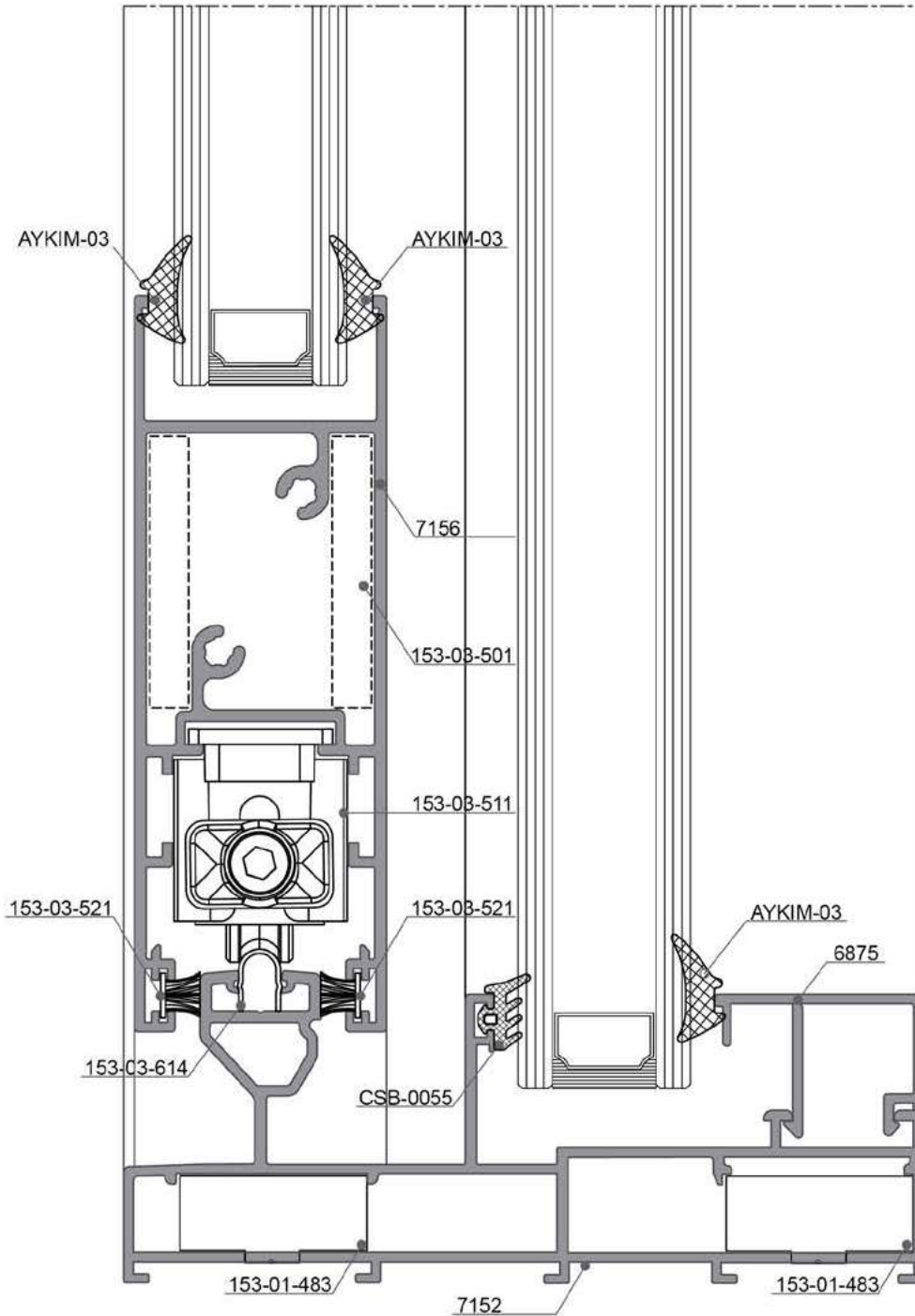
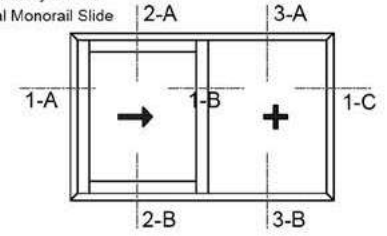
 3-B
 DETAYI
 DETAIL

Ölçek: 1:1 / Scale: 1:1

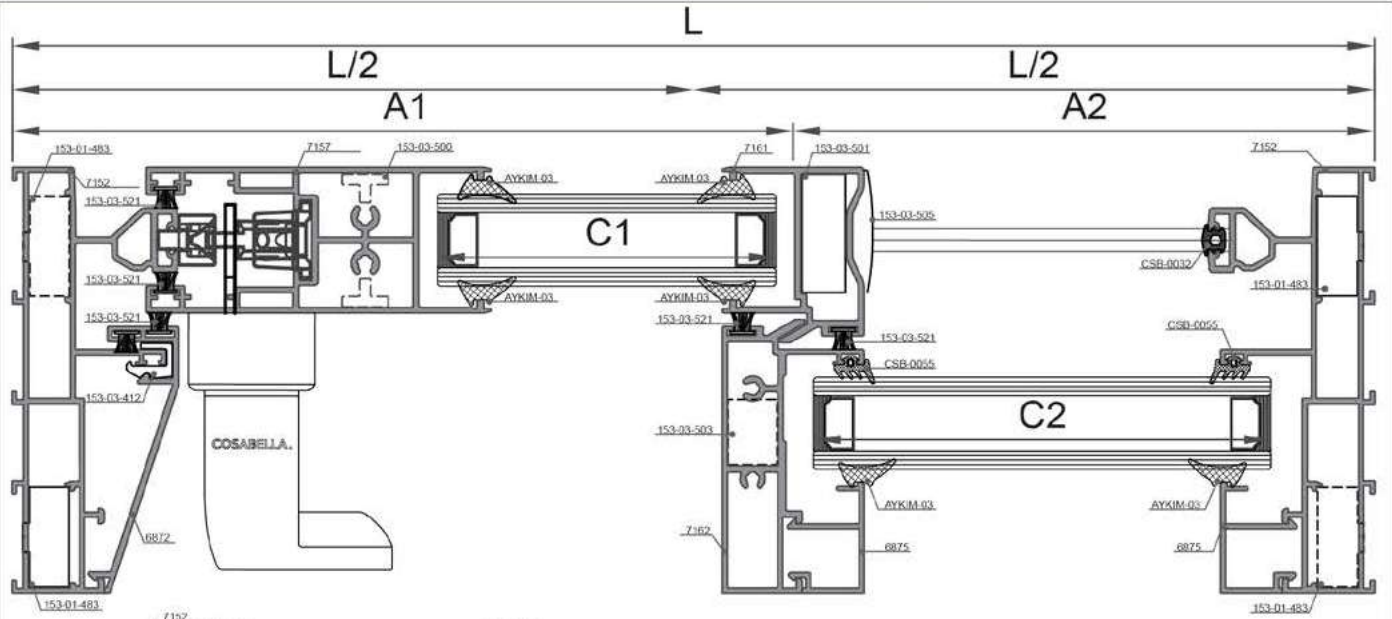
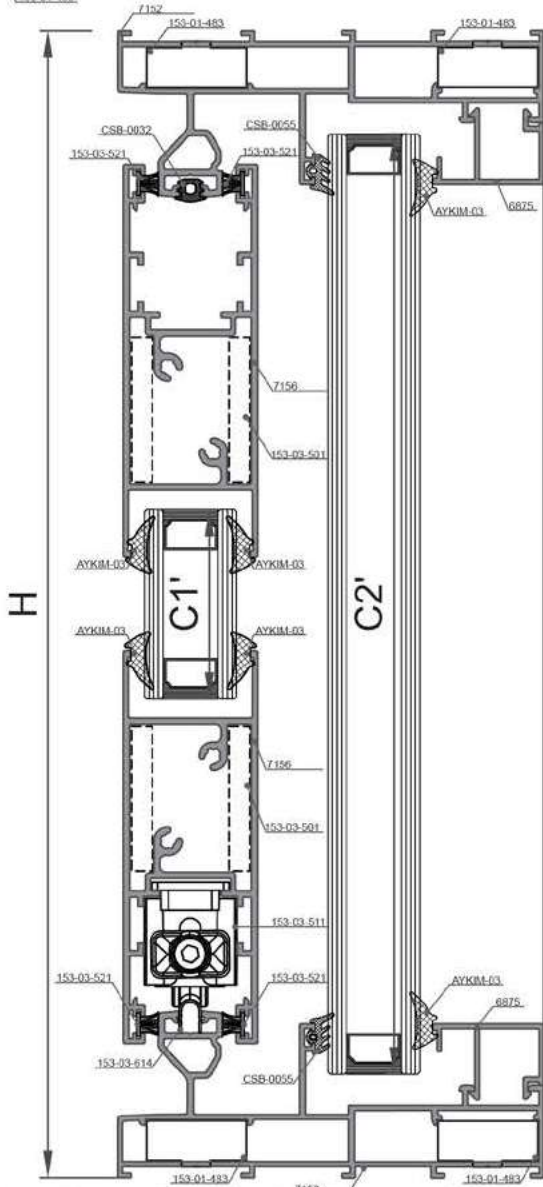
1-1 DETAYI
DETAIL3-3 DETAYI
DETAIL

Kesim ölçüsü - cam ölçüsü vb. sorumluluğu tarafımıza ait değildir.

	153-01-483 Vidalı Köşe Bağ. Takozu Screwed Corner Cleat	8 Ad. 8 Pcs.		153-03-511 Ayarlı Rulman Adjustable Roller	2 Ad. 2 Pcs.
	153-03-500 90° Geniş Köşe Bağlantı 90° Wide Sash Cor.Joint	2 Ad. 2 Pcs.		153-03-504 Kasa Alt & Üst Tozluğ Central Top & Bottom Sealing	1 Tkm. 1 Set.
	153-03-501 90°Dar Köşe Bağlantı 90° Narrow Sash Cor.Joint	2 Ad. 2 Pcs.		153-03-508 Stoplama Stoppage	2 Ad. 2 Pcs.
	153-03-503 90°Dar Köşe Bağlantı 90° Narrow Sash Cor.Joint	1 Tkm. 1 Set.		153-03-521 67-650'lik Kumuş Fınlı Kıl Fırlı Brush Pile Seal	6H+4L
	153-03-412 Adaptör Kinetleme Klipsi Plastic Lock Clips	30cm ara ile kullanılacak.		CSB-0032 Ray Kapama Contası Gasket For Frame Rails	2H+1L
	153-03-505 Adaptör Kapağı Alt & Üst Adapter Cap Bottom & Top	1 Tkm. 1 Set.		AYKIM-03 Glazing Wedge Gasket (Cam Terçimine Göre) (Optional Glass Size)	4C1'+4C1'+ 2C2'+2C2
	153-03-614 Paslanmaz Çelik Ray Stainless Steel Rail Track	L-75,64 mm. 1 Ad./Pcs.		CSB-0055 Dış Cam Contası External Glass Gasket	2C2'+2C2

90° Klasik Tek Ray Sürme
90° Classical Monorail Slide

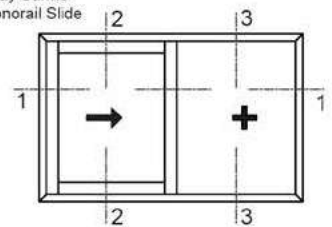

Çizimler 1/2 Ölçeklidir.

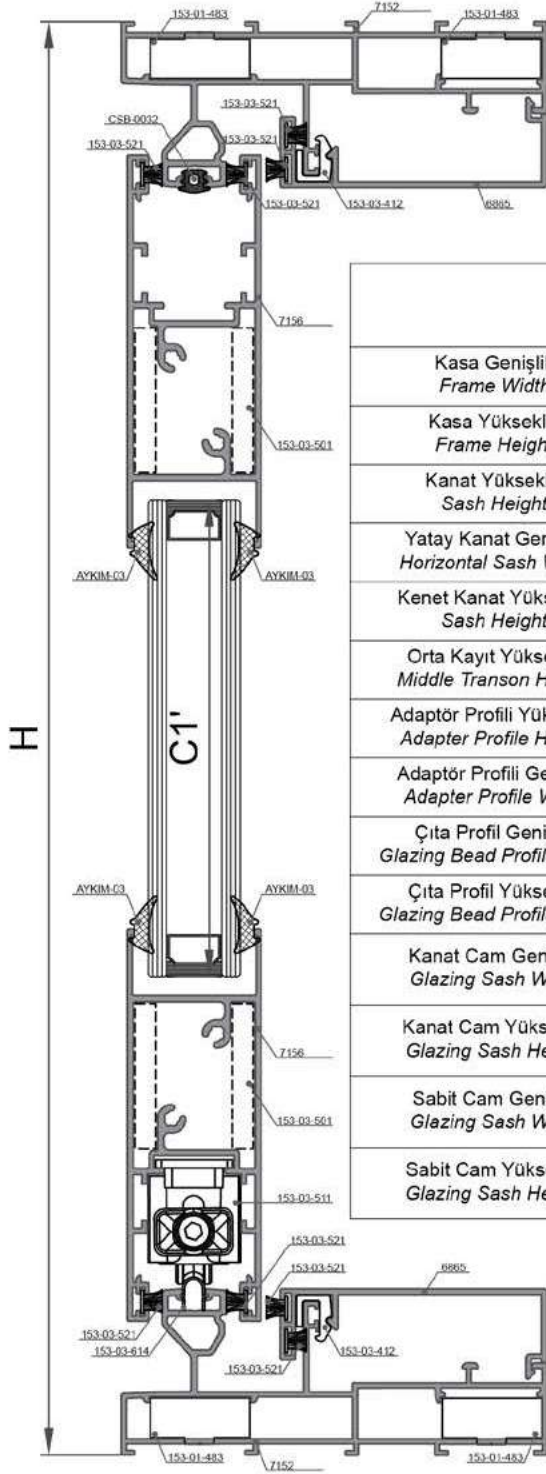

Kasa Genişlik Frame Width	7152			2 Ad. 2 Pcs.	L
Kasa Yükseklik Frame Height	7152			2 Ad. 2 Pcs.	H
Kanat Yükseklik Sash Height	7157			1 Ad. 1 Pcs.	H-76
Yatay Kanat Genişlik Horizontal Sash Width	7156			2 Ad. 2 Pcs.	A1-139,41
Kenet Kanat Yükseklik Sash Height	7161			1 Ad. 1 Pcs.	H-76
Orta Kayıt Yükseklik Middle Transon Height	7162			1 Ad. 1 Pcs.	H-80,46
Adaptör Profili Yükseklik Adapter Profile Height	6872			1 Ad. 1 Pcs.	H-87
Adaptör Profili Genişlik Adapter Profile Width	6865			2 Ad. 2 Pcs.	A1-42,51
Çıta Profil Genişlik Glazing Bead Profile Width	6875			2 Ad. 2 Pcs.	A2-26,39
Çıta Profil Yükseklik Glazing Bead Profile Height	6875			2 Ad. 2 Pcs.	H-80,46
Kanat Cam Genişlik Glazing Sash Width				1 Ad. 1 Pcs.	A1-115,42
Kanat Cam Yükseklik Glazing Sash Height				1 Ad. 1 Pcs.	H-250
Sabit Cam Genişlik Glazing Sash Width				1 Ad. 1 Pcs.	A2-32,4
Sabit Cam Yükseklik Glazing Sash Height				1 Ad. 1 Pcs.	H-54,2

 2-2 DETAYI
 DETAIL

Kesim ölçüsü - cam ölçüsü vb. sorumluluğu tarafımıza ait değildir.

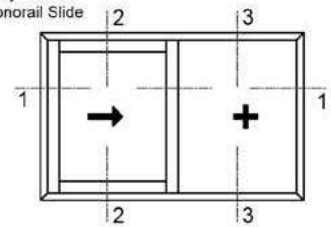
 90° Klasik Tek Ray Sürme
 90° Classical Monorail Slide

Çizimler 1/2 Ölçeklidir.

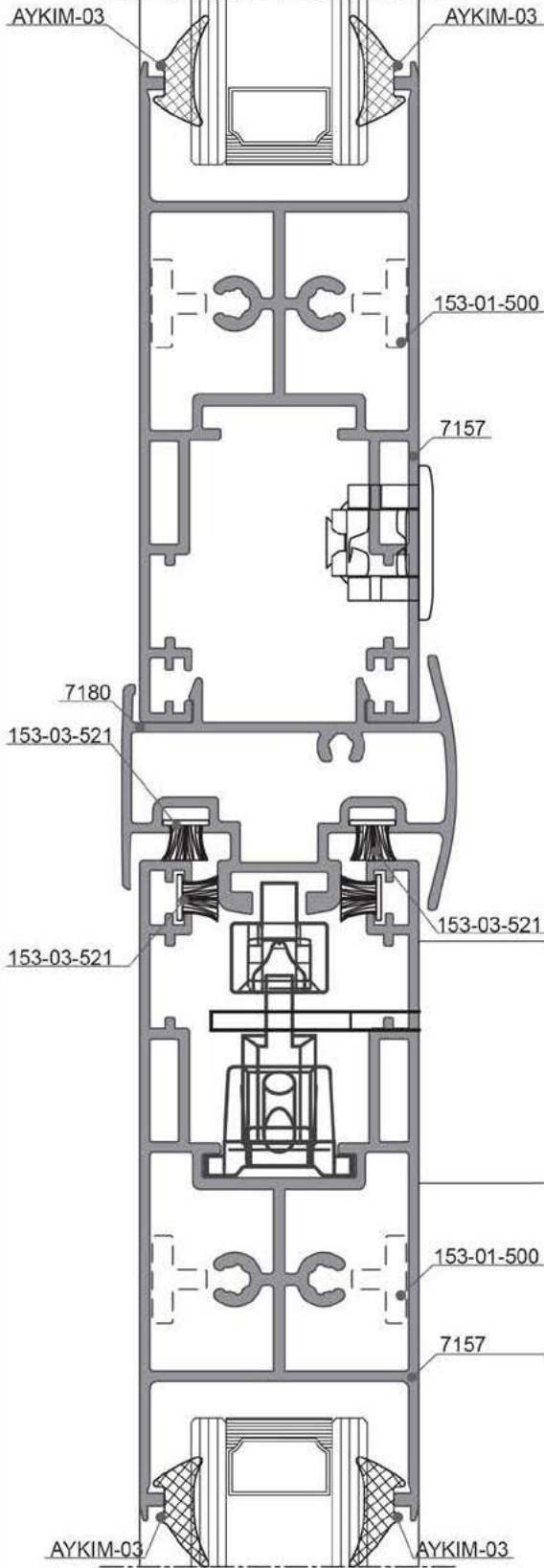
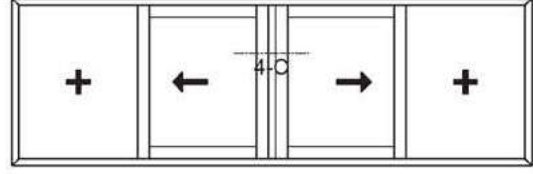
90° Klasik Tek Ray Sürme
90° Classical Monorail Slide4-C DETAYI
DETAIL

Ölçek: 1:1 / Scale: 1:1

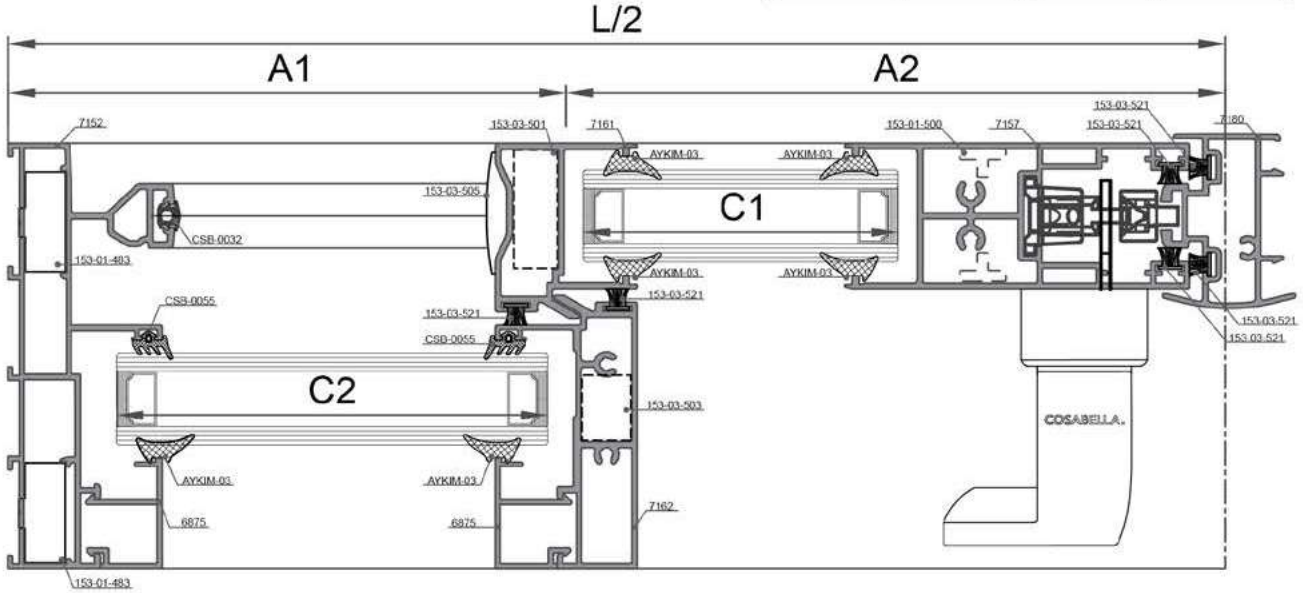
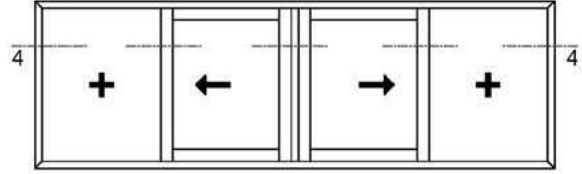
90° Klasik Tek Ray Sürme
 90° Classical Monorail Slide

Kasa Genişlik Frame Width	7152			2 Ad. 2 Pcs.	L
Kasa Yükseklik Frame Height	7152			2 Ad. 2 Pcs.	H
Yatay Kanat Genişlik Horizontal Sash Width	7156			4 Ad. 4 Pcs.	A2-113,9
Kanat Yükseklik Sash Height	7157			2 Ad. 2 Pcs.	H-76
Kenet Kanat Yükseklik Sash Height	7161			2 Ad. 2 Pcs.	H-76
Kenet Kanat Yükseklik Sash Height	7162			2 Ad. 2 Pcs.	H-76
Adaptör Profil Yükseklik Adapter Profile Height	7180			1 Ad. 1 Pcs.	H-106
Çıta Profil Genişlik - Yükseklik Glazing Bead Pr. Width - Height	6875			4 Ad. 4 Pcs.	A1-26,47 H-80,46
Kanat Cam Genişlik Glazing Sash Width				2 Ad. 2 Pcs.	A2-90
Kanat Cam Yükseklik Glazing Sash Height				2 Ad. 2 Pcs.	H-250
Sabit Cam Genişlik Glazing Sash Height				2 Ad. 2 Pcs.	A1-33
Sabit Cam Yükseklik Glazing Sash Height				2 Ad. 2 Pcs.	H-54,2

Kesim ölçüsü - cam ölçüsü vb. sorumluluğu tarafımıza ait değildir.

Çizimler 1/2 Ölçeklidir.

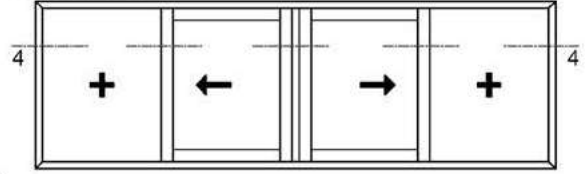
90° Klasik Tek Ray Sürme
90° Classical Monorail Slide

L/2

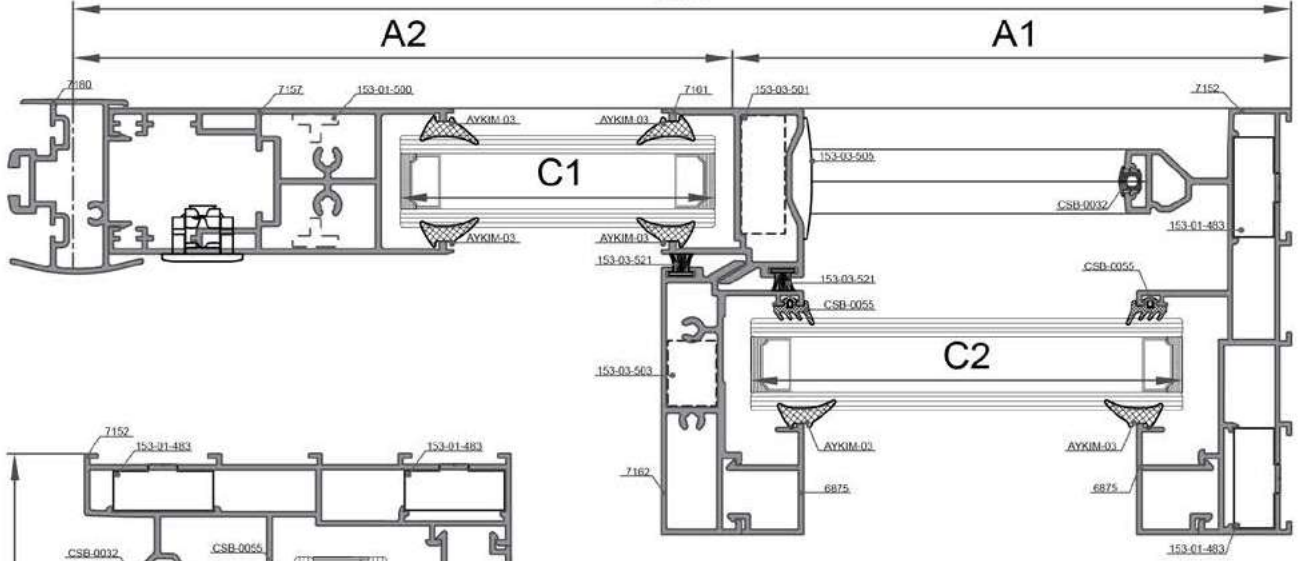
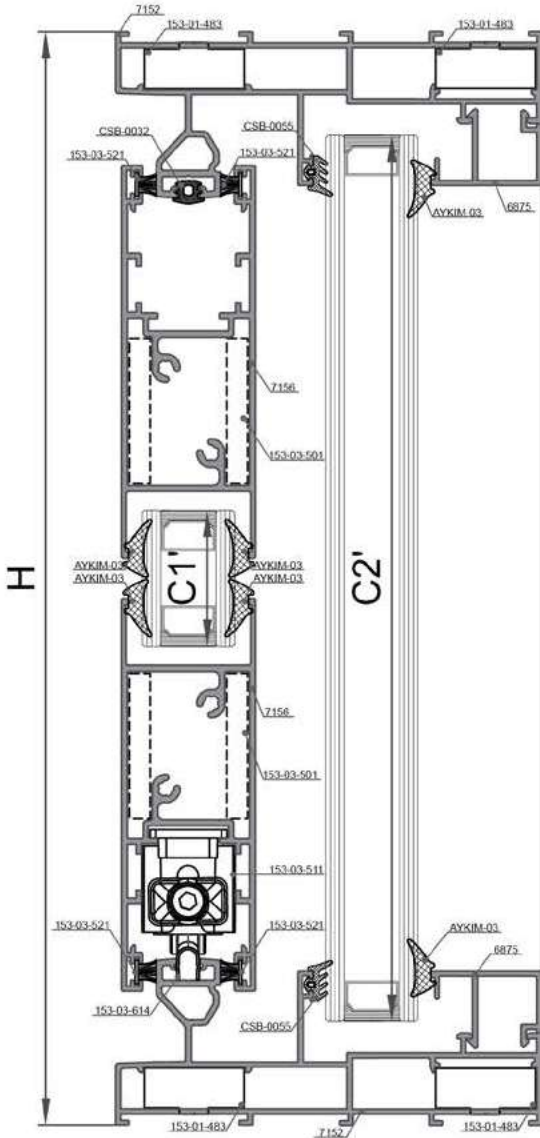
4-4 DETAYI
DETAIL

	153-01-483 Vidalı Köşe Bağ Takozu Screwed Corner Cleat	8 Ad. 8 Pcs.		153-03-504 Kasa Alt & Üst Tozluk Central Top & Bottom Sealing	2 Tkm. 2 Set.
	153-03-500 90° Geniş Köşe Bağlantı 90° Wide Sash Cor-Joint	4 Ad. 4 Pcs.		153-03-508 Stoplama Stoppage	4 Ad. 4 Pcs.
	153-03-501 90° Dar Köşe Bağlantı 90° Narrow Sash Cor-Joint	4 Ad. 4 Pcs.		153-03-507 Cosabella SD-33 4'lü Kanat Adaptör Kapağı Cosabella SD-33 4 Winged Lid	1 Tkm. 1 Set.
	153-03-503 90° Dar Köşe Bağlantı 90° Narrow Sash Cor-Joint	2 Tkm. 2 Set.		153-03-521 67-850'lik Kumşafı Fınlı Kıl Fıtlı Brush Pile Seal	8H+4L
	153-03-412 Adaptör Kemerleme Klipsi Plastic Lock Clips	30cm ara ile kullanılacak.		CSB-0032 Ray Kapama Contası Gasket For Frame Rails	2H+1L
	153-03-505 Adaptör Kapağı Alt & Üst Adapter Cap Bottom & Top	2 Tkm. 2 Set.		AYKIM-03 Glazing Wedge Gasket (Cam Terçimine Göre) (Optional Glass Size)	4C2+8C1+ 4C2+8C1'
	153-03-614 Paslanmaz Çelik Ray Stainless Steel Rail Track	L-75,04 mm. 1 Ad./Pcs.		CSB-0055 Dış Cam Contası External Glass Gasket	4C2+4C2
	153-03-511 Ayarlı Rulman Adjustable Roller	4 Ad. 4 Pcs.			

Çizimler 1/2 Ölçeklidir.

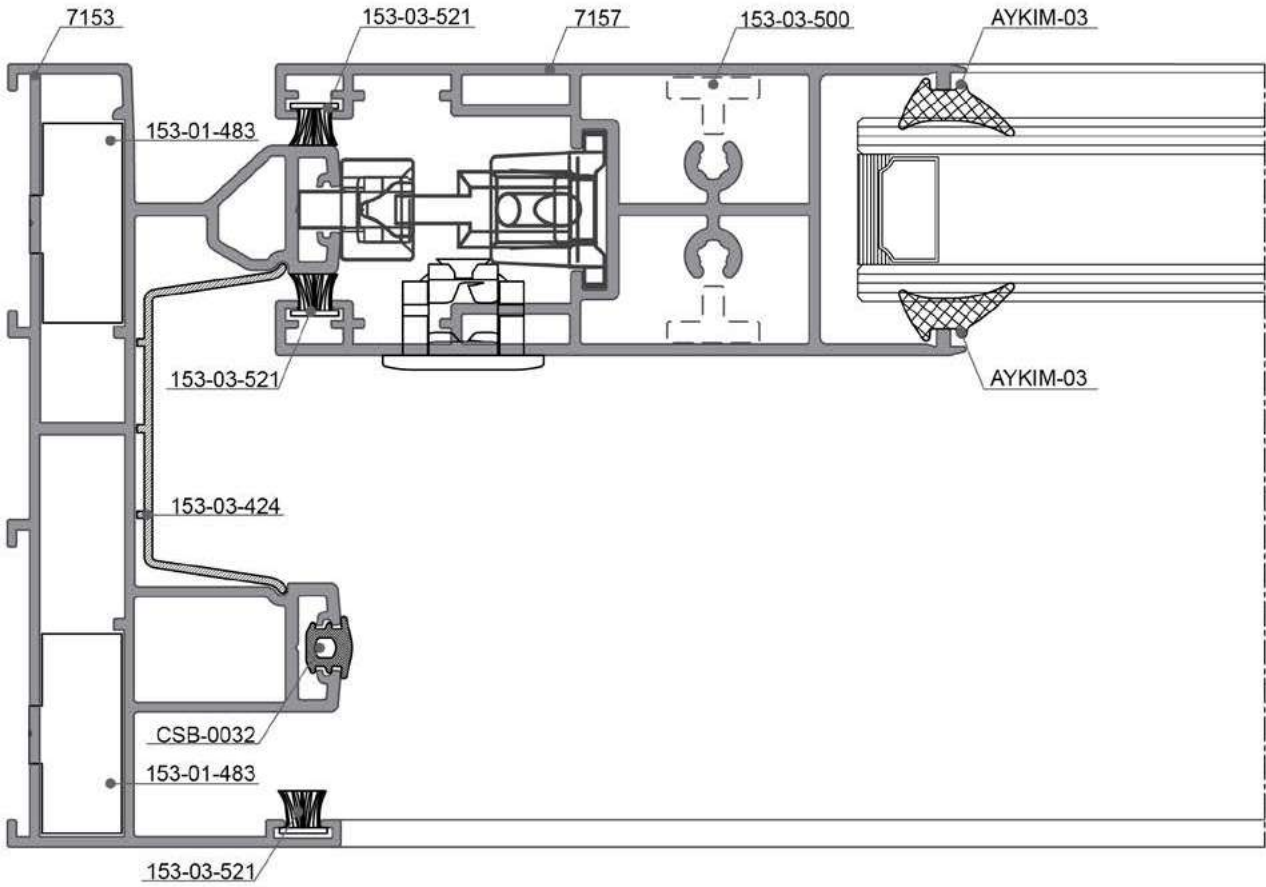
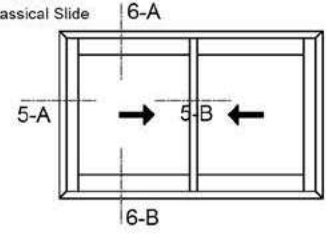
90° Klasik Sürme
 90° Classical Slide

 5-A DETAYI
 DETAIL

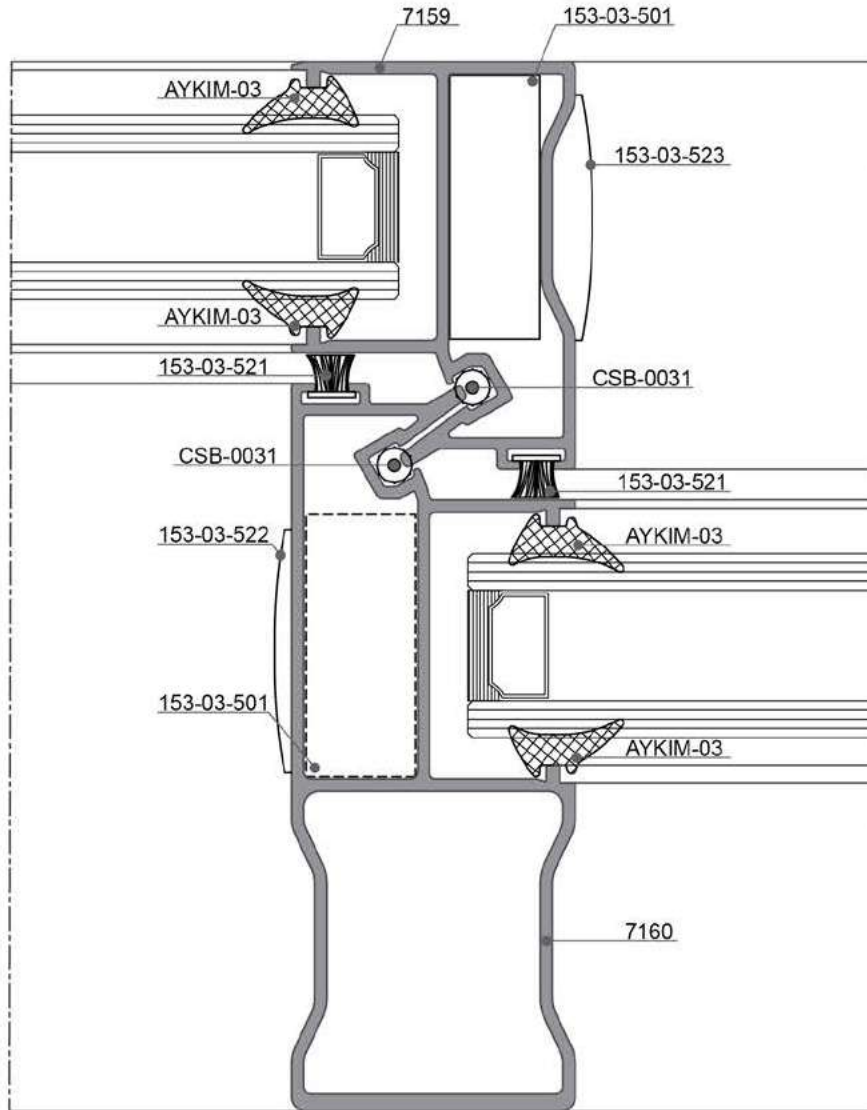
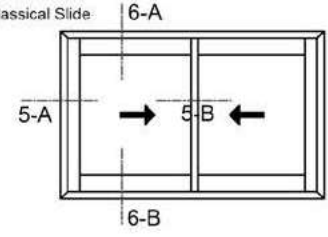
Ölçek: 1:1 / Scale: 1:1

90° Klasik Sürme
90° Classical Slide5-B DETAYI
DETAIL

Ölçek: 1:1 / Scale: 1:1

90° Klasik Sürme
 90° Classical Slide

6-A

5-A

5-B

6-B

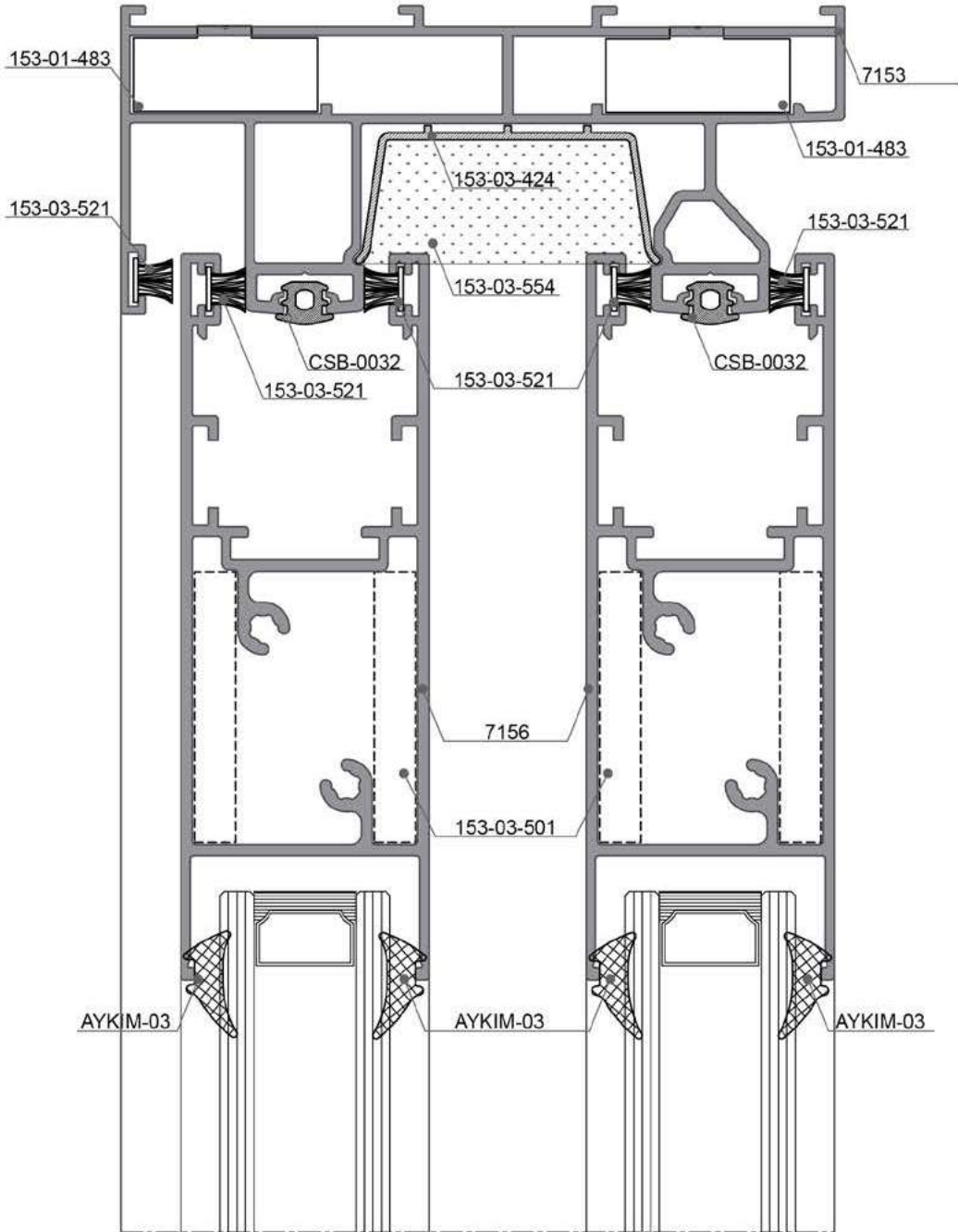
 6-A
 DETAYI
 DETAIL

Ölçek: 1:1 / Scale: 1:1

90° Klasik Sürme
90° Classical Slide

6-A

5-A

5-B

6-B

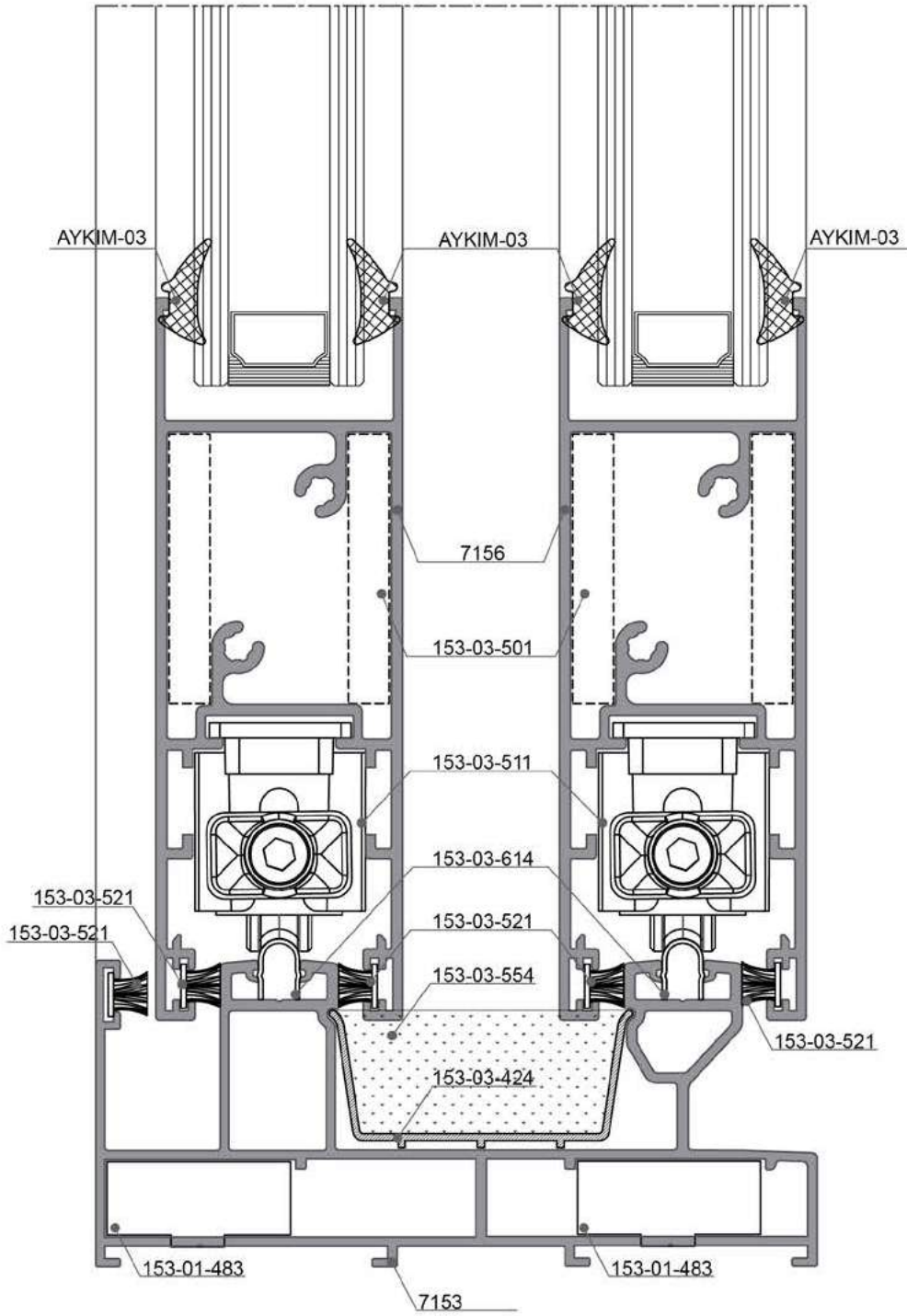
6-B DETAYI
DETAIL



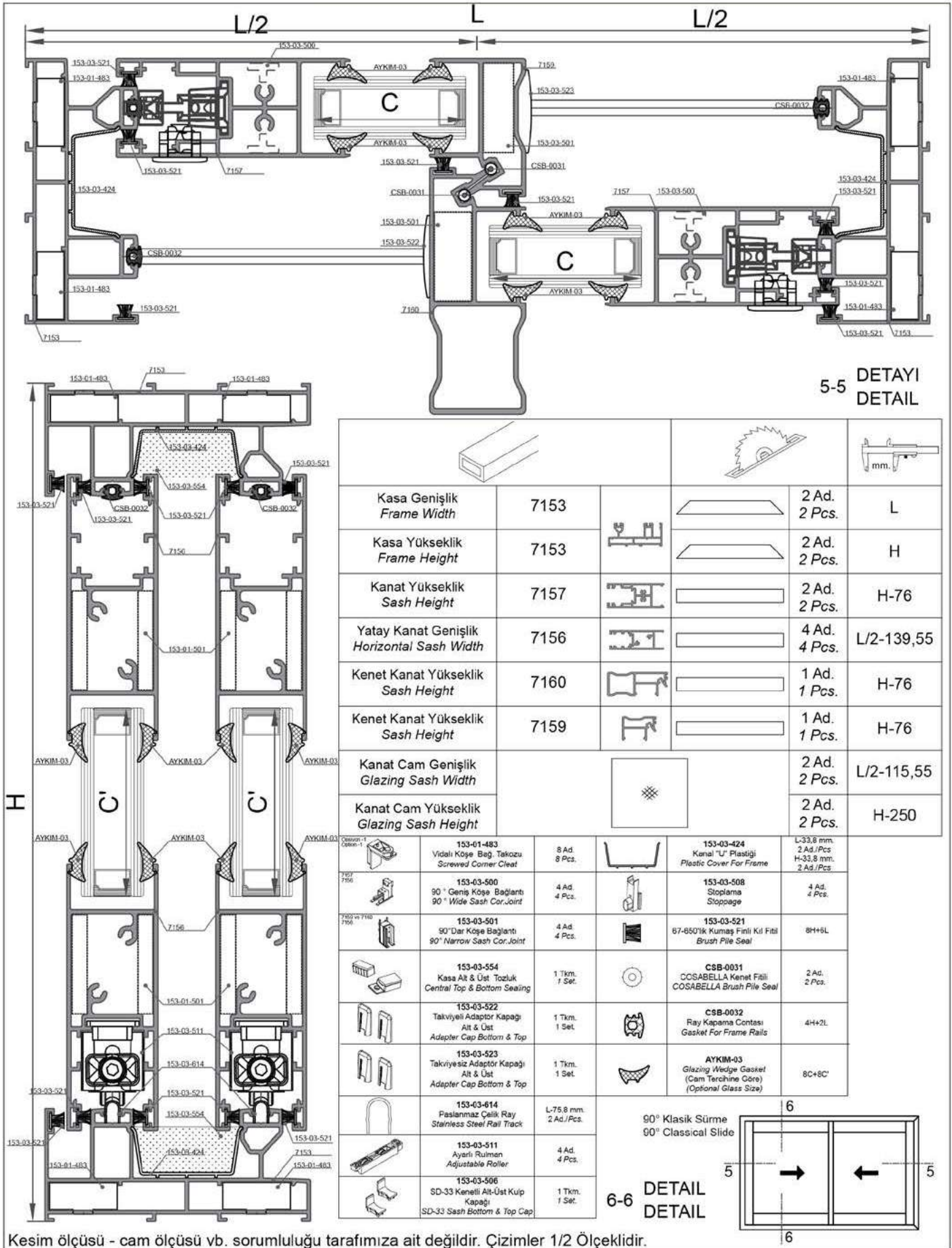



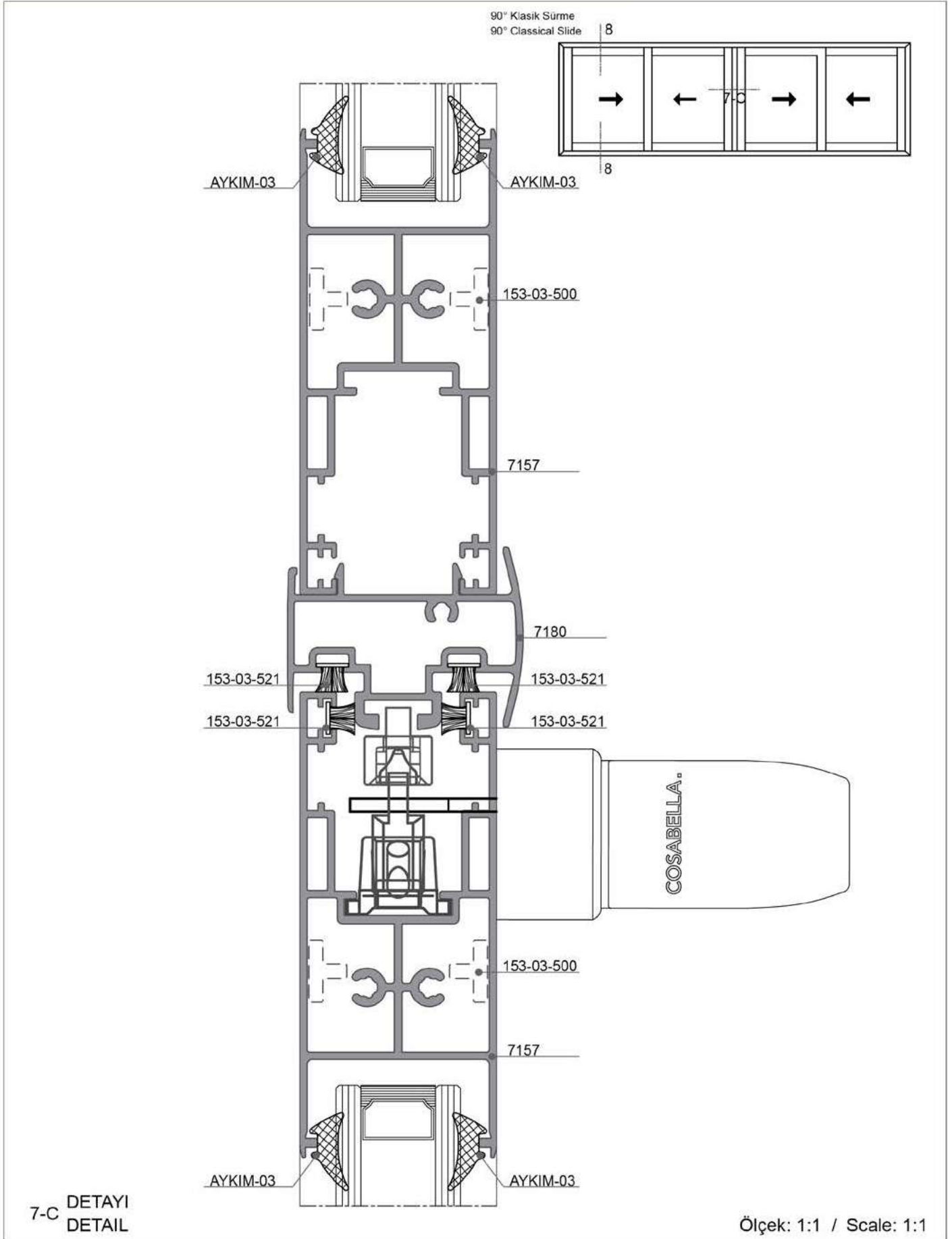

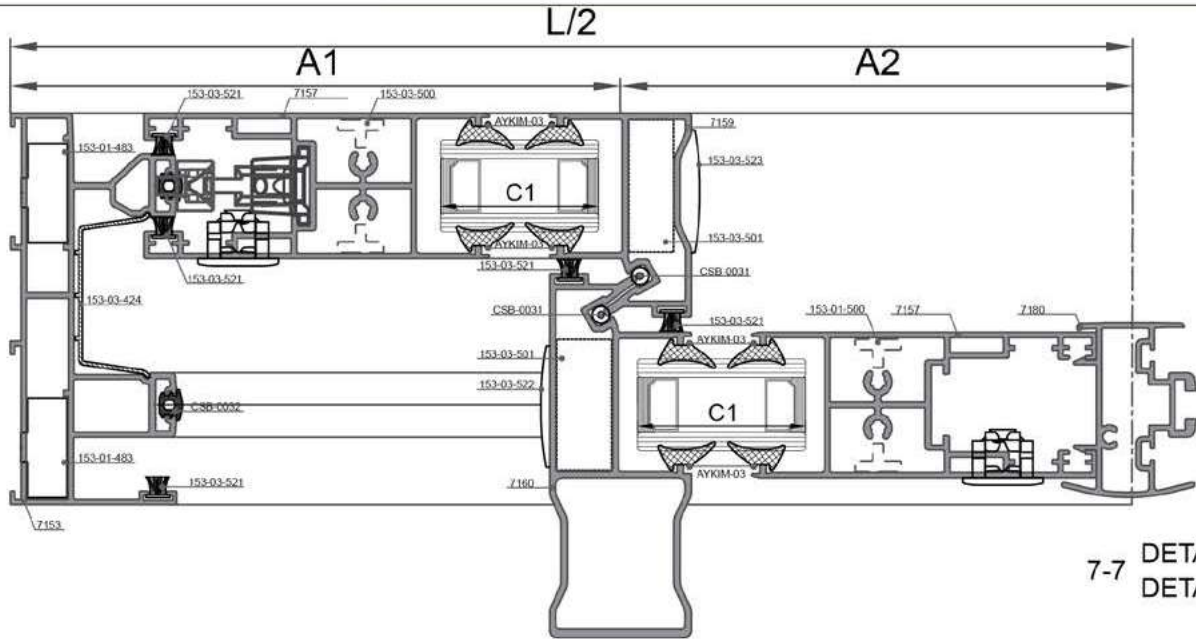

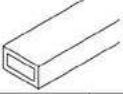
Ölçek: 1:1 / Scale: 1:1



Kesim ölçüsü - cam ölçüsü vb. sorumluluğu tarafımıza ait değildir. Çizimler 1/2 Ölçeklidir.



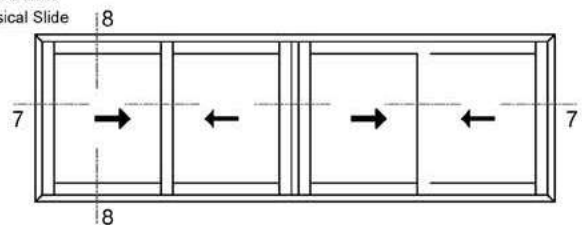

 7-7 DETAYI
 DETAIL

			
Kasa Genişlik Frame Width	7152		2 Ad. 2 Pcs. L
Kasa Yükseklik Frame Height	7152		2 Ad. 2 Pcs. H
Kanat Yükseklik Sash Height	7157		4 Ad. 4 Pcs. H-76
Yatay Kanat Genişlik Horizontal Sash Width	7156		8 Ad. 8 Pcs. A1-139,5
Kenet Kanat Yükseklik Sash Height	7159		2 Ad. 2 Pcs. H-76
Kenet Kanat Yükseklik Sash Height	7160		2 Ad. 2 Pcs. H-76
Adaptör Profil Yükseklik Adapter Profile Height	7180		1 Ad. 1 Pcs. H-106
Kanat Cam Genişlik Glazing Sash Width			4 Ad. 4 Pcs. A1-115,5
Kanat Cam Yüksekliklik Glazing Sash Height			4 Ad. 4 Pcs. H-250

 90° Klasik Sürme
 90° Classical Slide

Kesim ölçüsü - cam ölçüsü vb. sorumluluğu tarafımıza ait değildir.

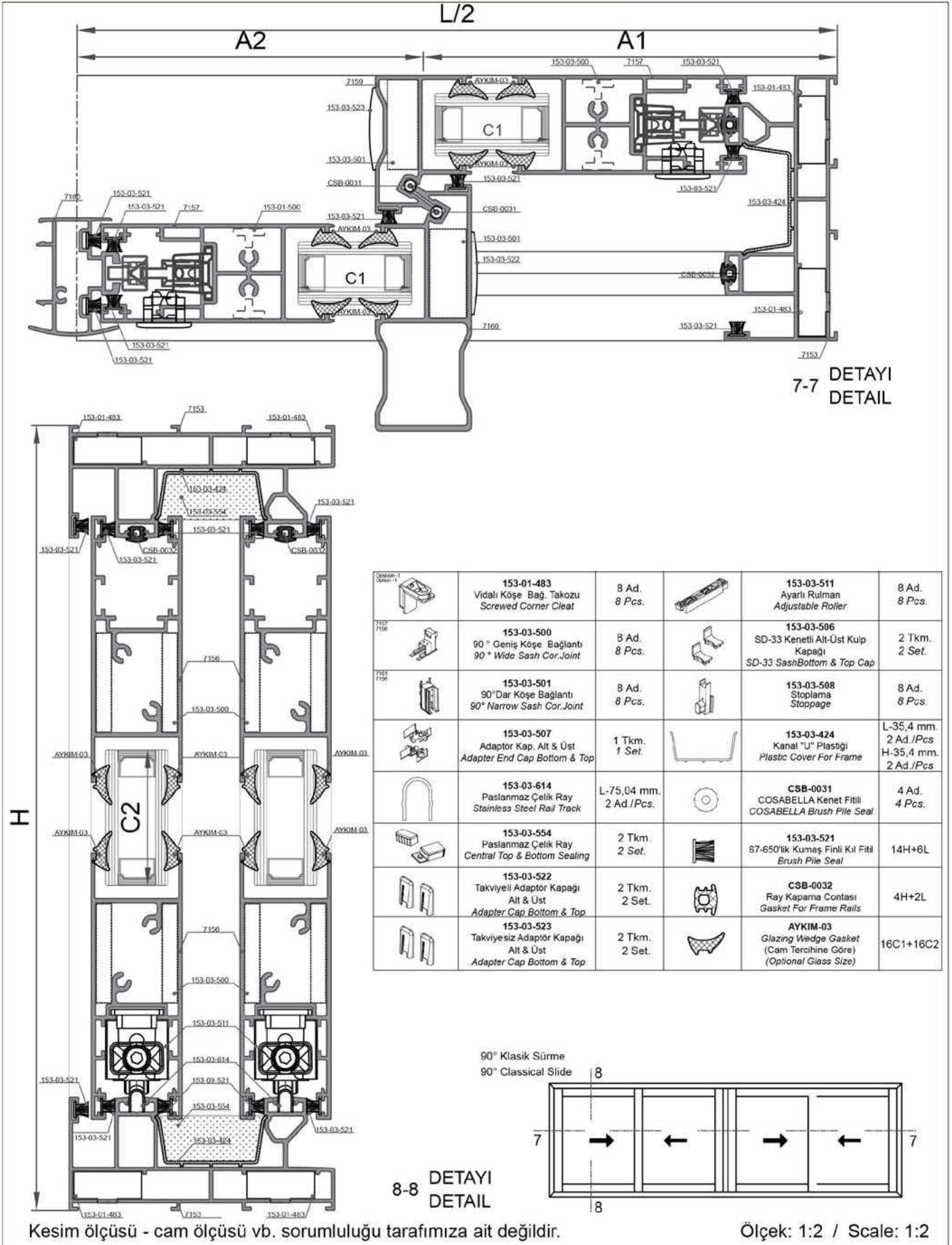
Ölçek: 1:2 / Scale: 1:2

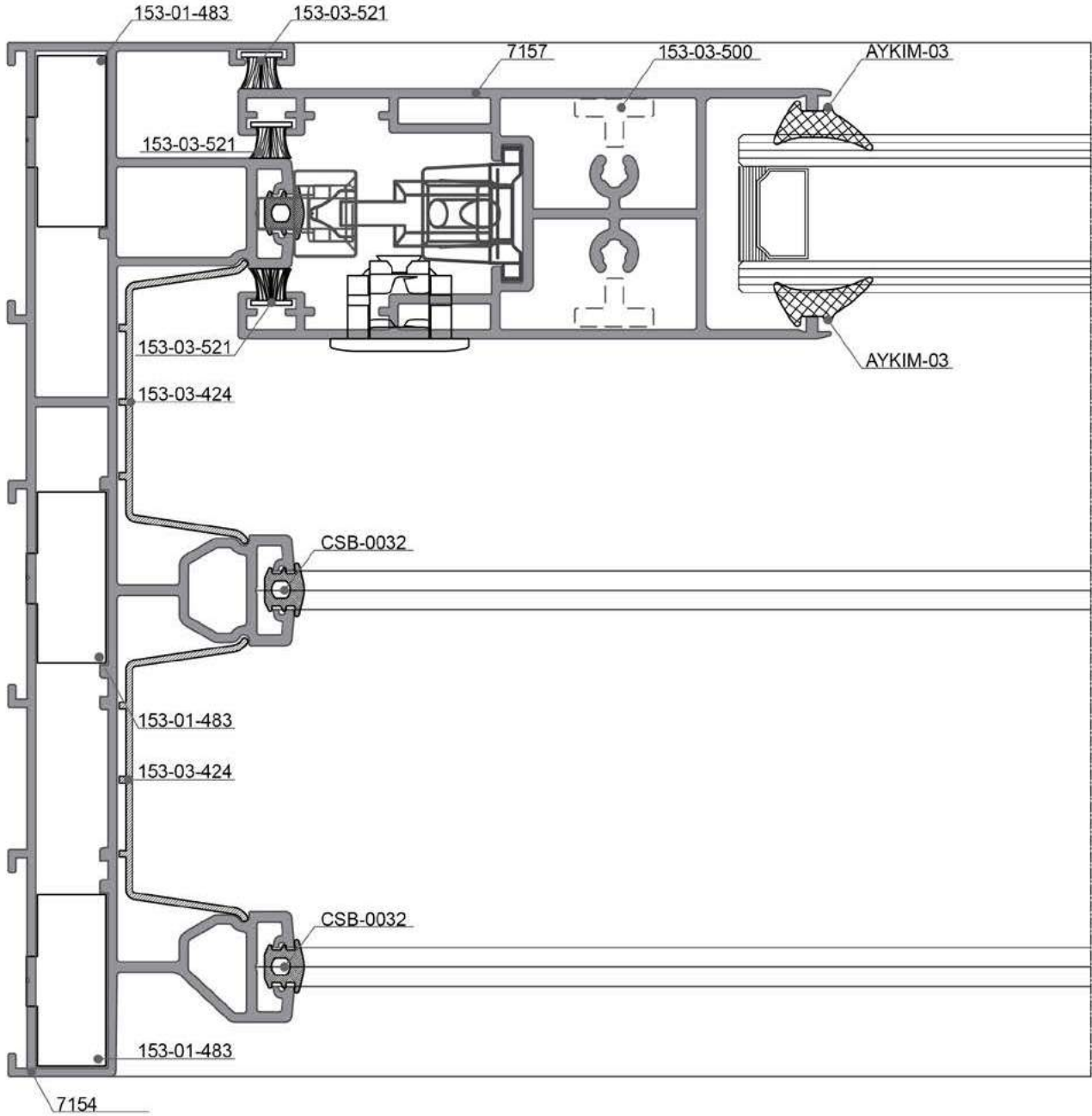
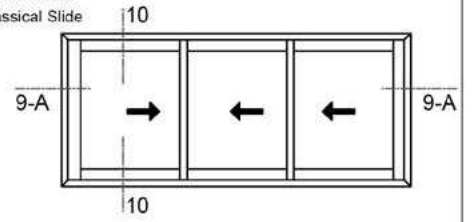

90° Klasik Sürme
 90° Classical Slide

 9-A DETAYI
 DETAIL

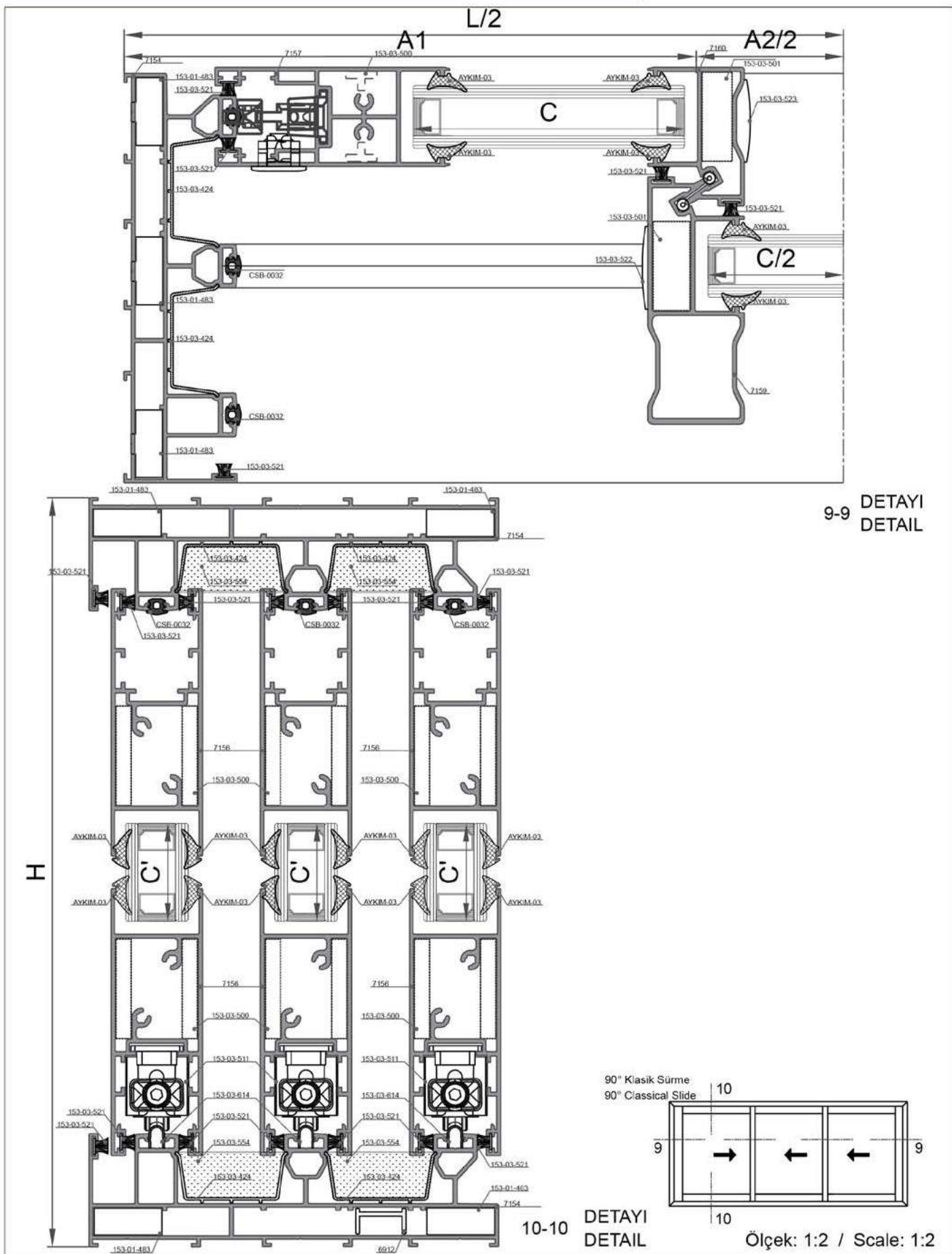
Ölçek: 1:1 / Scale: 1:1

9-9 DETAYI
DETAIL10-10 DETAYI
DETAIL

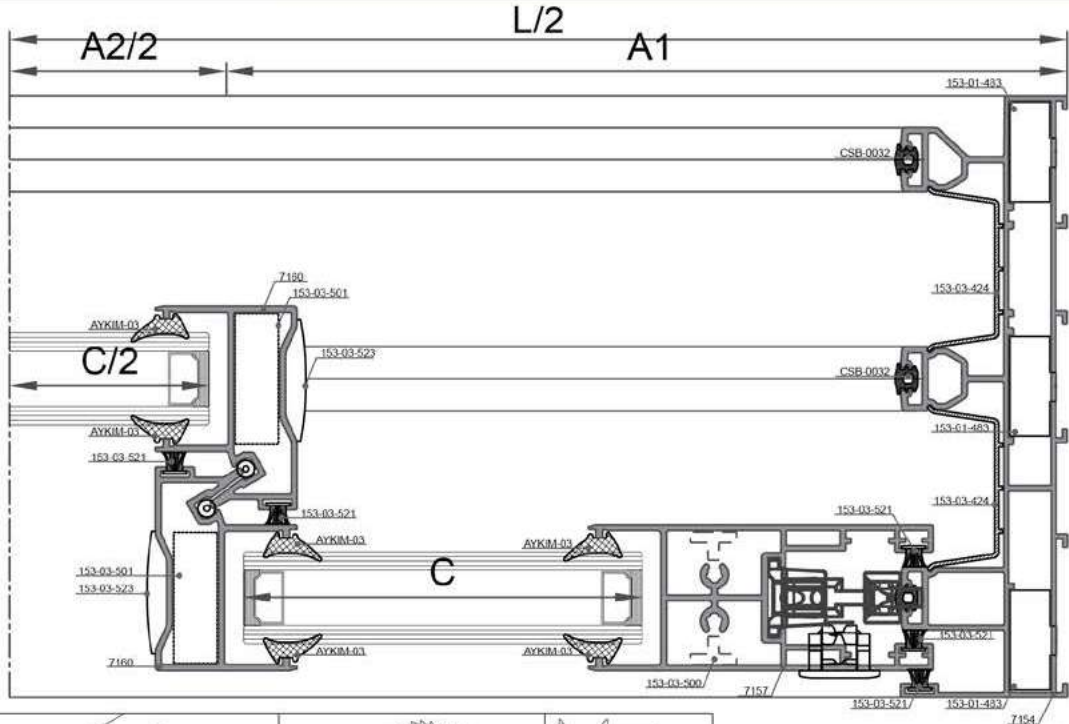
Ölçek: 1:2 / Scale: 1:2

 DETAYI
 9-9
 DETAIL

Kasa Genişlik Frame Width	7154			2 Ad. 2 Pcs.	L
Kasa Yükseklik Frame Height	7154			2 Ad. 2 Pcs.	H
Kanat Yükseklik Sash Height	7157			2 Ad. 2 Pcs.	H-76
Yatay Kanat Genişlik Horizontal Sash Width	7156			6 Ad. 6 Pcs.	A1-139,5
Kenet Kanat Yükseklik Sash Height	7159			1 Ad. 1 Pcs.	H-76
Kenet Kanat Yükseklik Sash Height	7160			3 Ad. 3 Pcs.	H-76
Destek Pr. Genişlik Support Pr. Width	6912			1 Ad. 1 Pcs.	L
Kanat Cam Genişlik Glazing Sash Width				3 Ad. 3 Pcs.	A1-115,5
Kanat Cam Yükseklik Glazing Sash Height				3 Ad. 3 Pcs.	H-250

	153-01-483 Vidalı Köşe Bağ. Takozlu Screwed Corner Cleat	8 Ad. 8 Pcs.		153-03-506 SD-33 Kenetli Alt-Üst Kulp Kapağı SD-33 SashBottom & Top Cap	1 Tkm. 1 Set.
	153-03-500 90° Geniş Köşe Bağlantı 90° Wide Sash Cor.Joint	4 Ad. 4 Pcs.		153-03-424 Kanal 'U' Plastik Kapak Plastic Cover For Frame	L-35,4 mm. 2 Ad./Pcs H-35,4 mm. 2 Ad./Pcs
	153-03-501 90° Dar Köşe Bağlantı 90° Narrow Sash Cor.Joint	8 Ad. 8 Pcs.		153-03-554 Kasa Alt & Üst Tozluk Central Top & Bottom Sealing	2 Tkm 2 Set.
	153-03-522 Takviyeli Adaptör Kapağı Alt & Üst Adapter Cap Bottom & Top	2 Tkm. 2 Set.		153-03-521 67-850'lık Kumuş Finitli Kılı Finitli Brush Pile Seal	10H+8L
	153-03-523 Takviyesiz Adaptör Kapağı Alt & Üst Adapter Cap Bottom & Top	2 Tkm. 2 Set.		CSB-0032 Ray Kapama Cortası Gasket For Frame Rails	6H+3L
	153-03-614 Paslanmaz Çelik Ray Stainless Steel Rail Track	L-75,48 mm. 3 Ad./Pcs.		AYKIM-03 Glazing Wedge Gasket (Cam Terçiline Gore) (Optional Glass Size)	12C+12C'
	153-03-511 Ayarlı Rulman Adjustable Roller	6 Ad. 6 Pcs.			

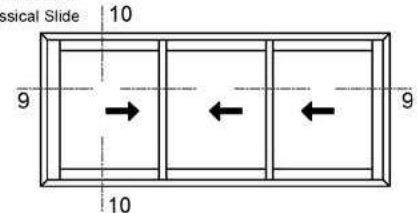
 90° Klasik Sürme
 90° Classical Slide

Kesim ölçüsü - cam ölçüsü vb. sorumluluğu tarafımıza ait değildir.

Ölçek: 1:2 / Scale: 1:2

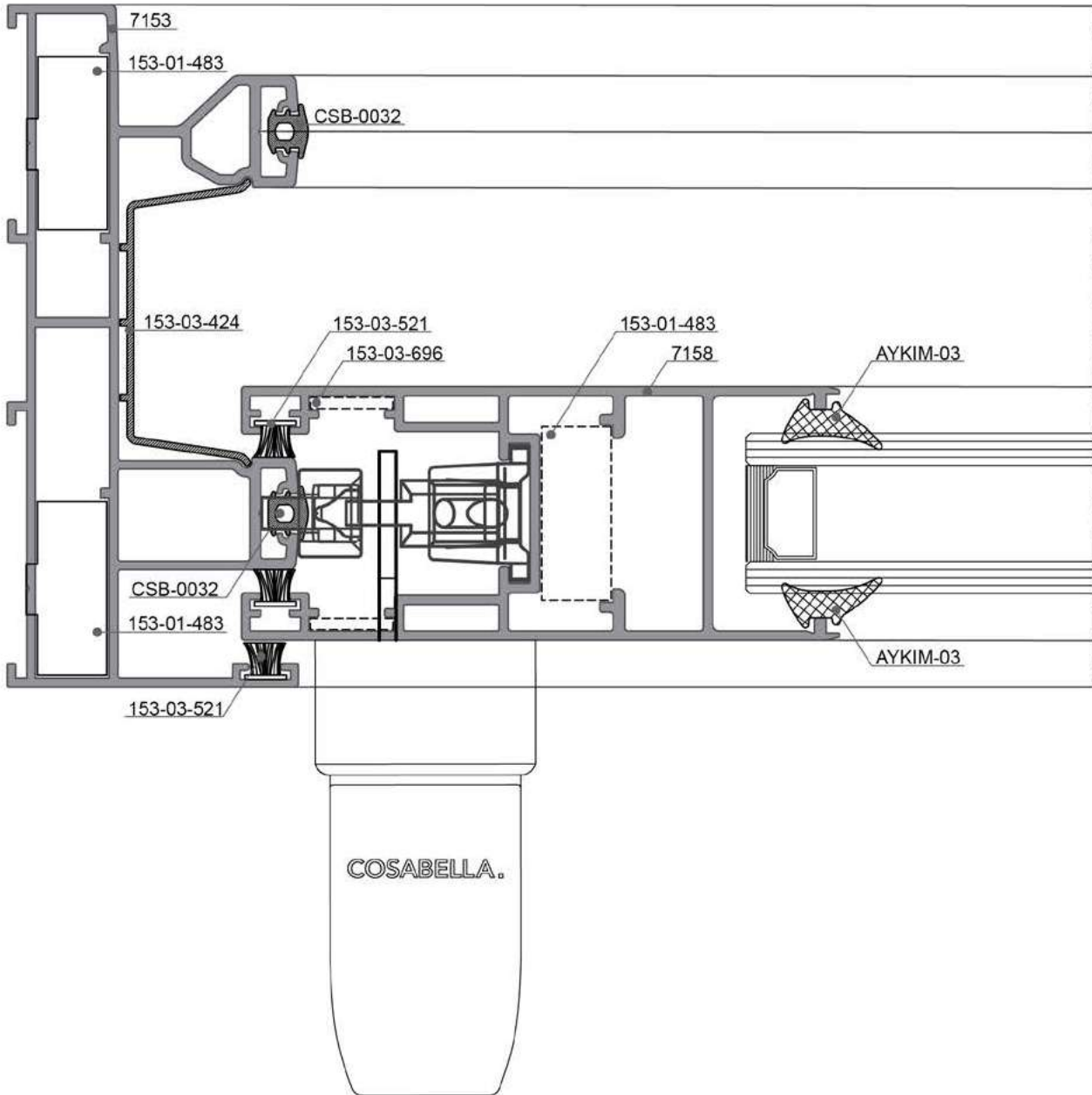
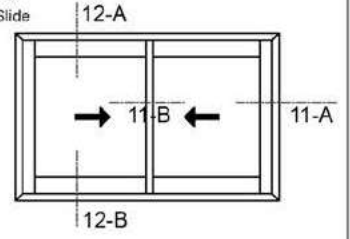
45° Klasik Sürme
45° Classical Slide11-A DETAYI
DETAIL

Ölçek: 1:1 / Scale: 1:1

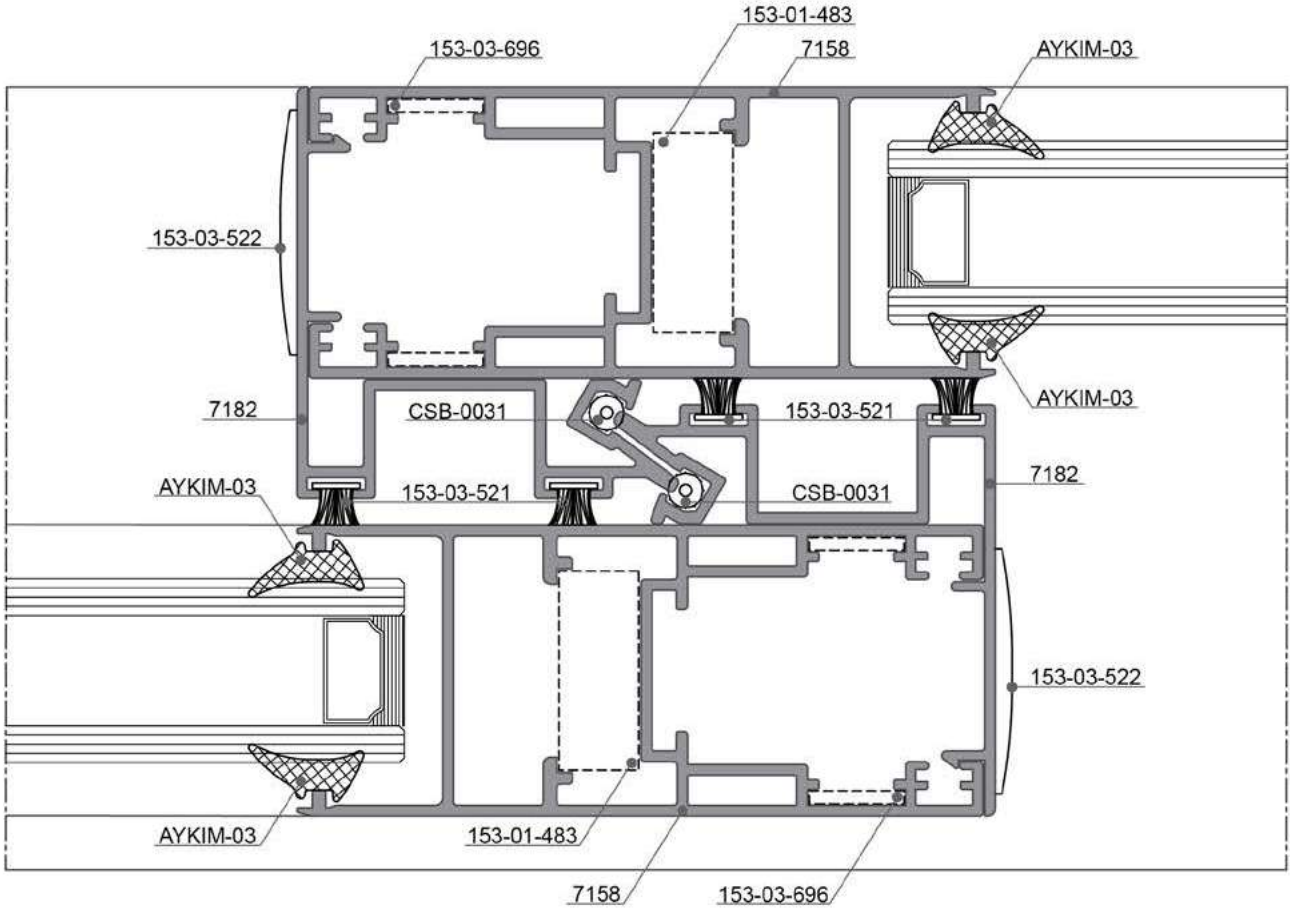
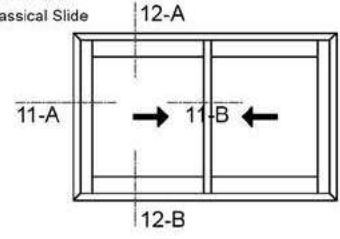
45° Klasik Sürme
 45° Classical Slide

 11-B DETAYI
 DETAIL

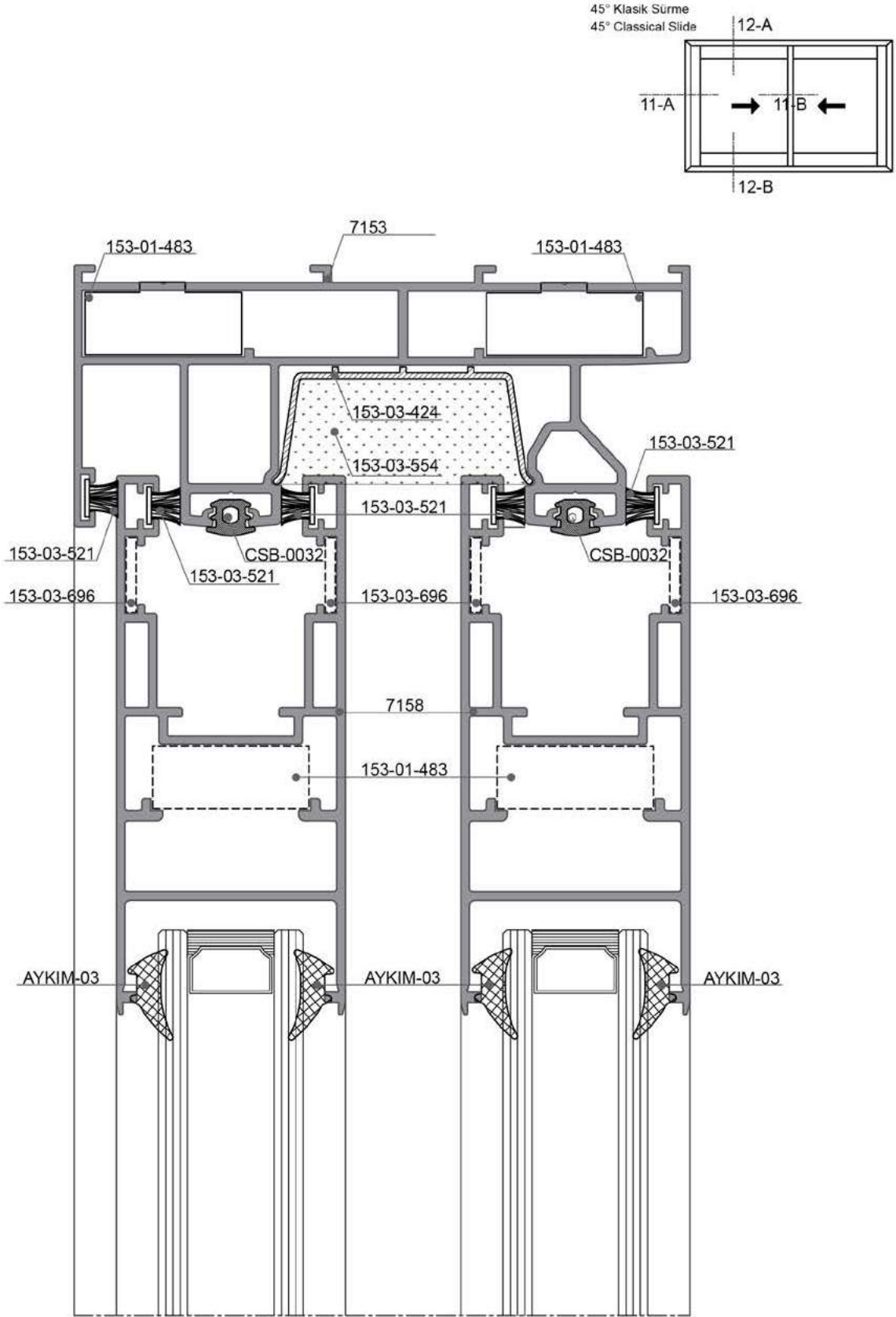
Ölçek: 1:1 / Scale: 1:1



12-A DETAYI
DETAIL

Ölçek: 1:1 / Scale: 1:1

45° Klasik Sürme
 45° Classical Slide

12-A

11-A

11-B

12-B

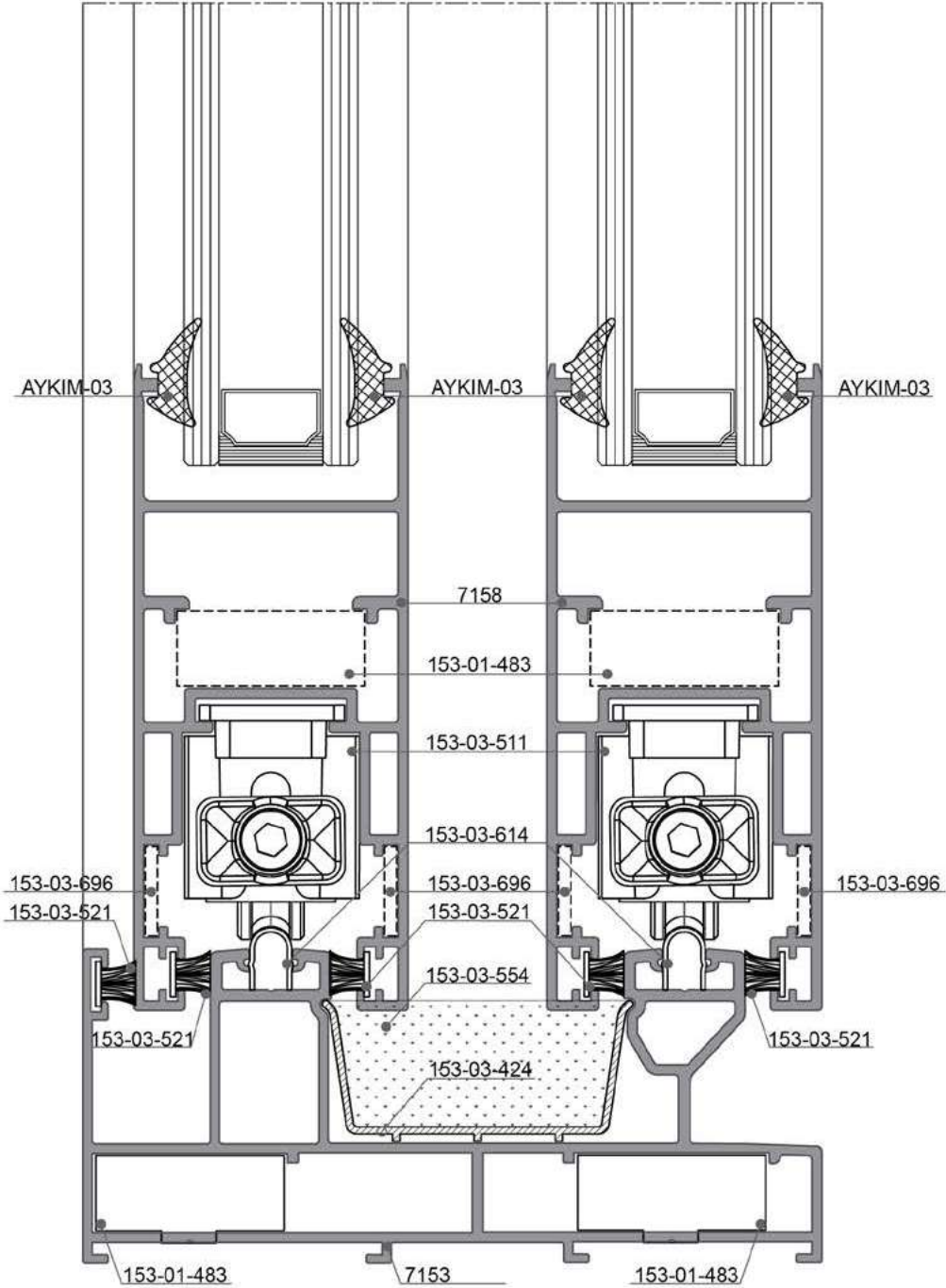
 12-B DETAYI
 DETAIL

Ölçek: 1:1 / Scale: 1:1

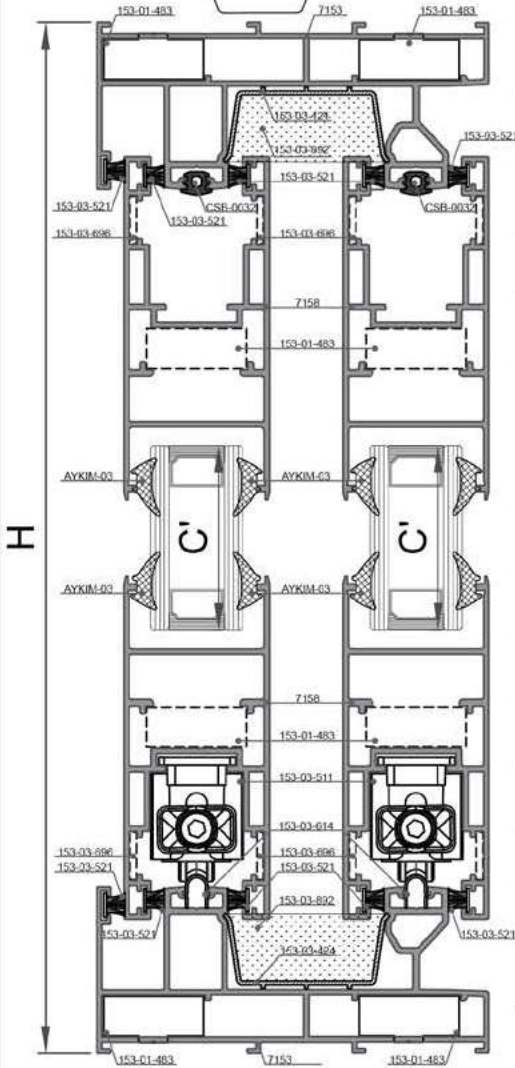
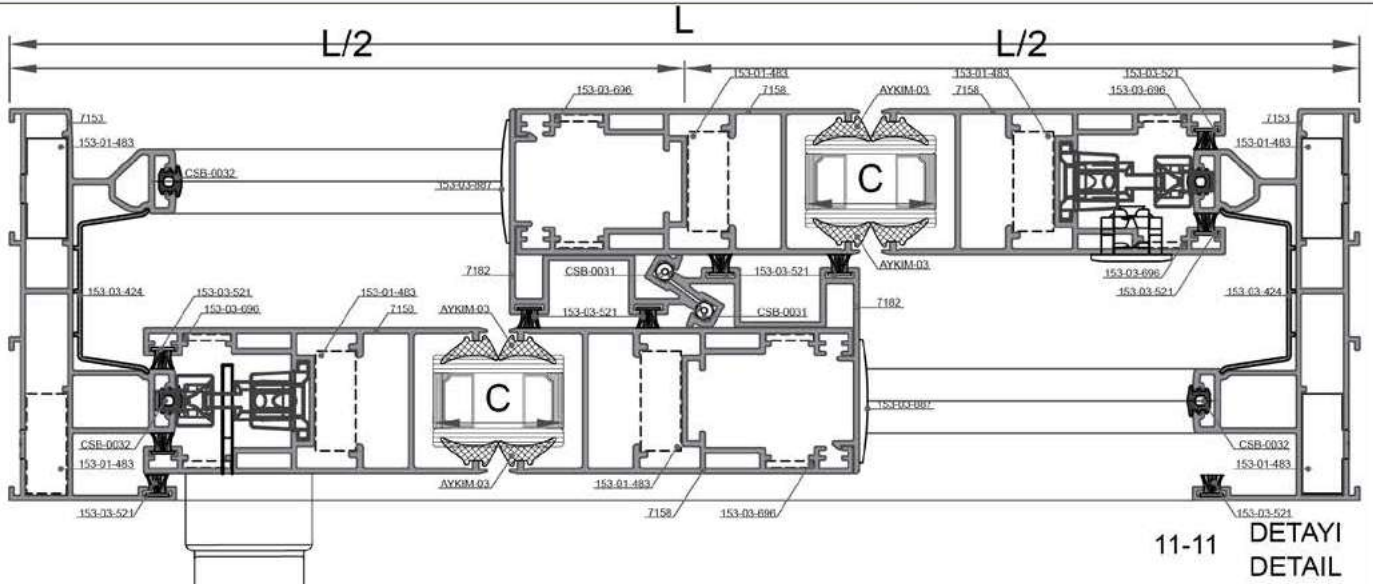

Kasa Genişlik Frame Width	7153			2 Ad. 2 Pcs.	L
Kasa Yükseklik Frame Height	7153			2 Ad. 2 Pcs.	H
Kanat Yükseklik Sash Height	7158			4 Ad. 4 Pcs.	H-70
Kanat Genişlik Sash Width	7158			4 Ad. 4 Pcs.	L/2+9,4
Kenet Kanat Yükseklik Sash Height	7182			2 Ad. 2 Pcs.	H-70
Kanat Cam Genişlik Glazing Sash Width				2 Ad. 2 Pcs.	L/2-147,6
Kanat Cam Yükseklik Glazing Sash Height				2 Ad. 2 Pcs.	H-227
Option 1 Option 2	153-01-483 Videli Köşe Bağ. Takozu Screwed Corner Cleat	16 Ad. 16 Pcs.		153-03-889 Stoplama Stoppage	4 Ad. 4 Pcs.
	153-03-887 Adapter Kapağı Alt & Üst Adapter Cap Bottom & Top	2 Tkm. 2 Set.		153-03-521 67-65C'lik Kumaz Fırlı Kil Fırlı Brush Pile Seal	10H+4L
	153-03-892 Kasa Alt & Üst Tozluk Central Top & Bottom Sealing	1 Tkm. 1 Set.		CSB-0032 Ray Kapama Contası Gasket For Frame Rails	4H+2L
	153-03-696 Kanat Köşe Gönye Alignment Square	16 Ad. 16 Pcs.		AYKIM-03 Glazing Wedge Gasket (Cam Tercihine Göre) (Optional Glass Size)	8C+8C'
	153-03-614 Paslanmaz Çelik Ray Stainless Steel Rail Track	L-75,48 mm. 2 Ad./Pcs.		CSB-0031 COSABELLA Kenet Fırlı COSABELLA Brush Pile Seal	2H
	153-03-511 Ayarlı Rulman Adjustable Roller	4 Ad. 4 Pcs.		45° Klasik Sürme 45° Classical Slide	
	153-03-424 Kanal "U" Plastiği Plastic Cover For Frame	L-35,4 mm. 2 Ad./Pcs. H-35,4 mm. 2 Ad./Pcs.			
	153-03-890 Sallantı Engelleme Shake Reducer	2 Ad. 2 Pcs.			





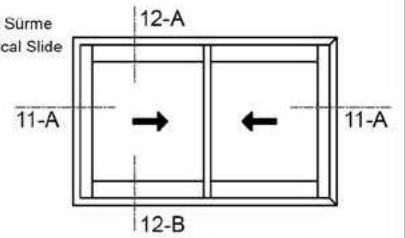



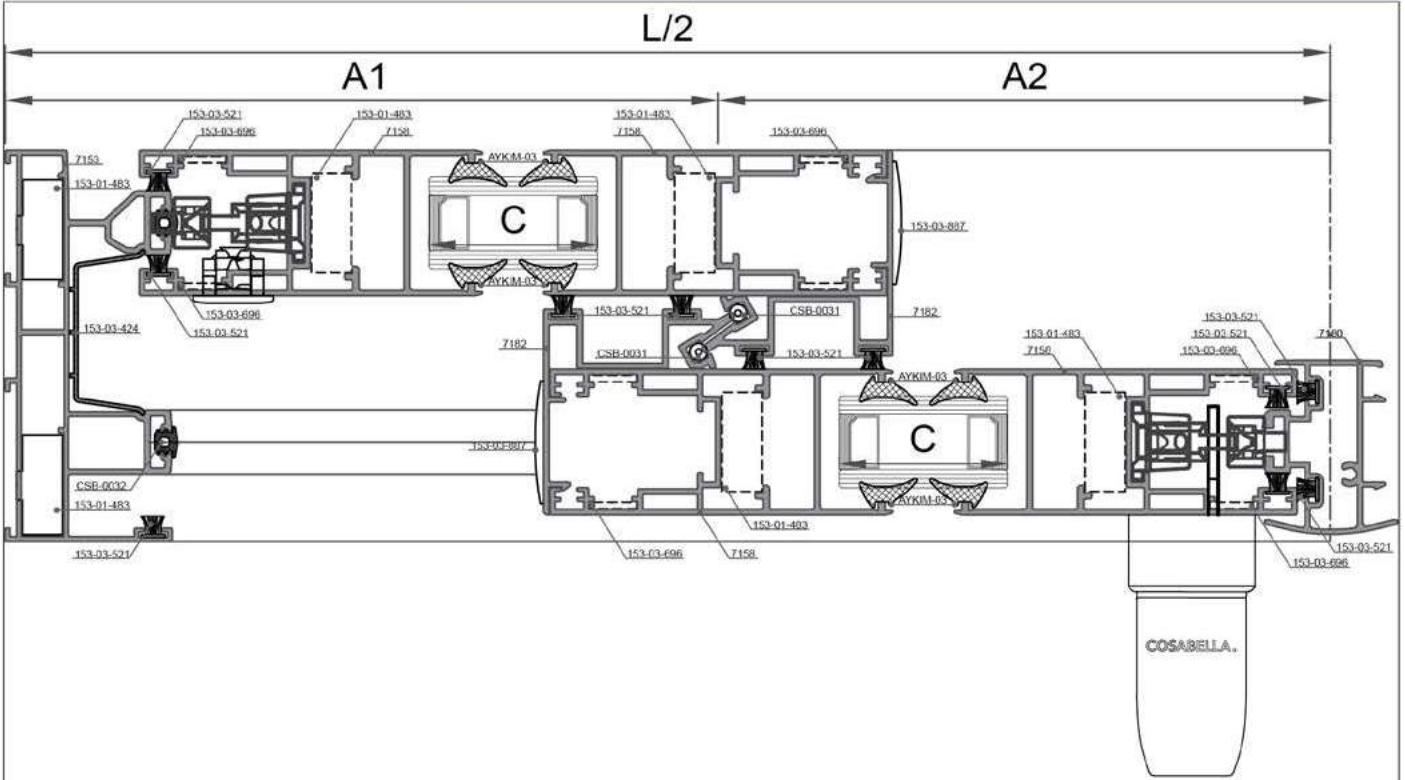

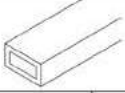
12-12 DETAYI
DETAIL

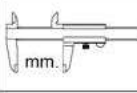
Kesim ölçüsü - cam ölçüsü vb. sorumluluğu tarafımıza ait değildir.



Ölçek: 1:2 / Scale: 1:2



			
Kasa Genişlik Frame Width	7153		2 Ad. 2 Pcs. L
Kasa Yükseklik Frame Height	7153		2 Ad. 2 Pcs. H
Kanat Yükseklik Sash Height	7158		8 Ad. 8 Pcs. H-70
Kanat Genişlik Sash Width	7158		8 Ad. 8 Pcs. L/2+9,4
Kenet Kanat Yükseklik Sash Height	7182		4 Ad. 4 Pcs. H-70
Adaptör Profil Yükseklik Adapter Profile Height	7180		1 Ad. 1 Pcs. H-106
Kanat Cam Genişlik Glazing Sash Width			4 Ad. 4 Pcs. A1-147,6
Kanat Cam Yükseklik Glazing Sash Height			4 Ad. 4 Pcs. H-227

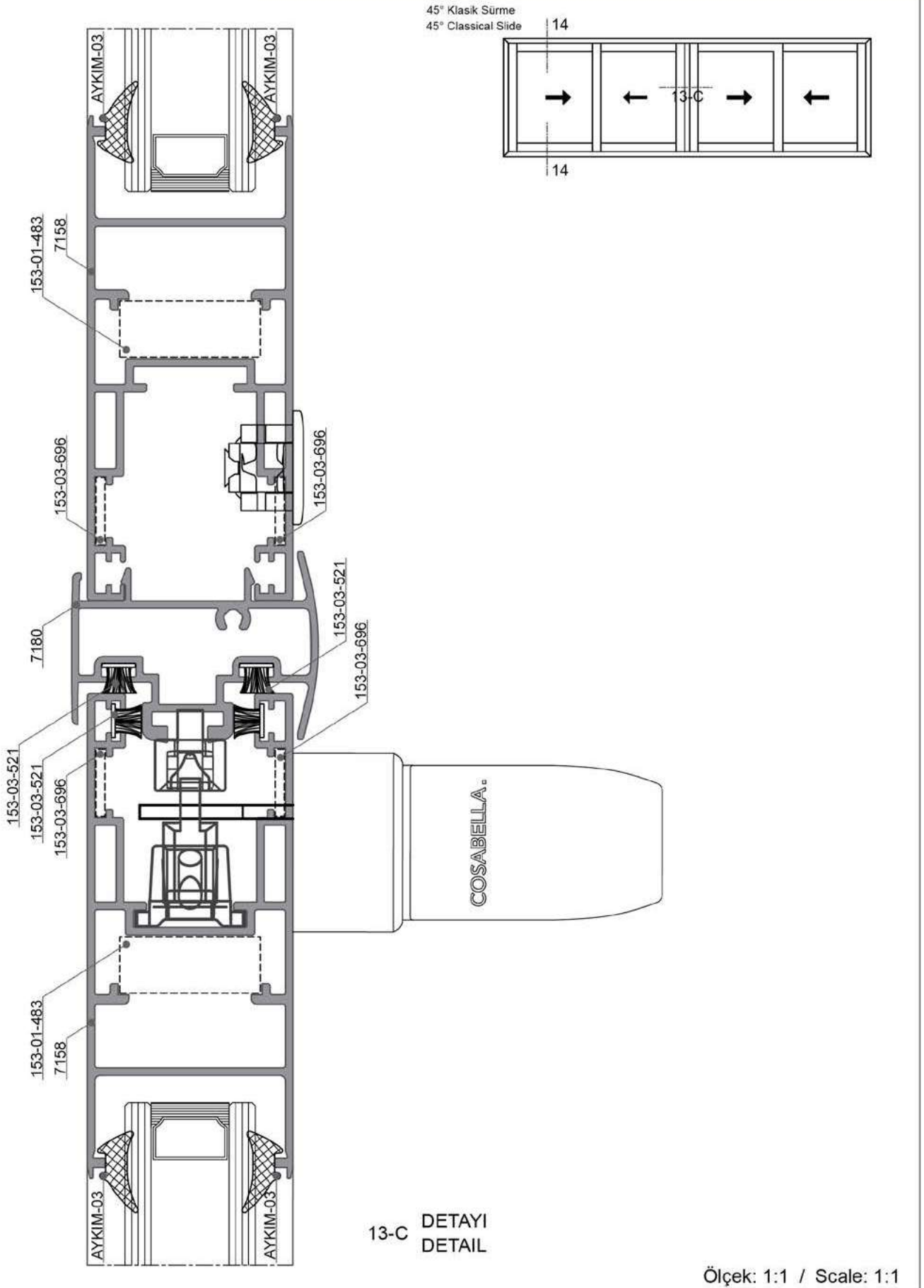

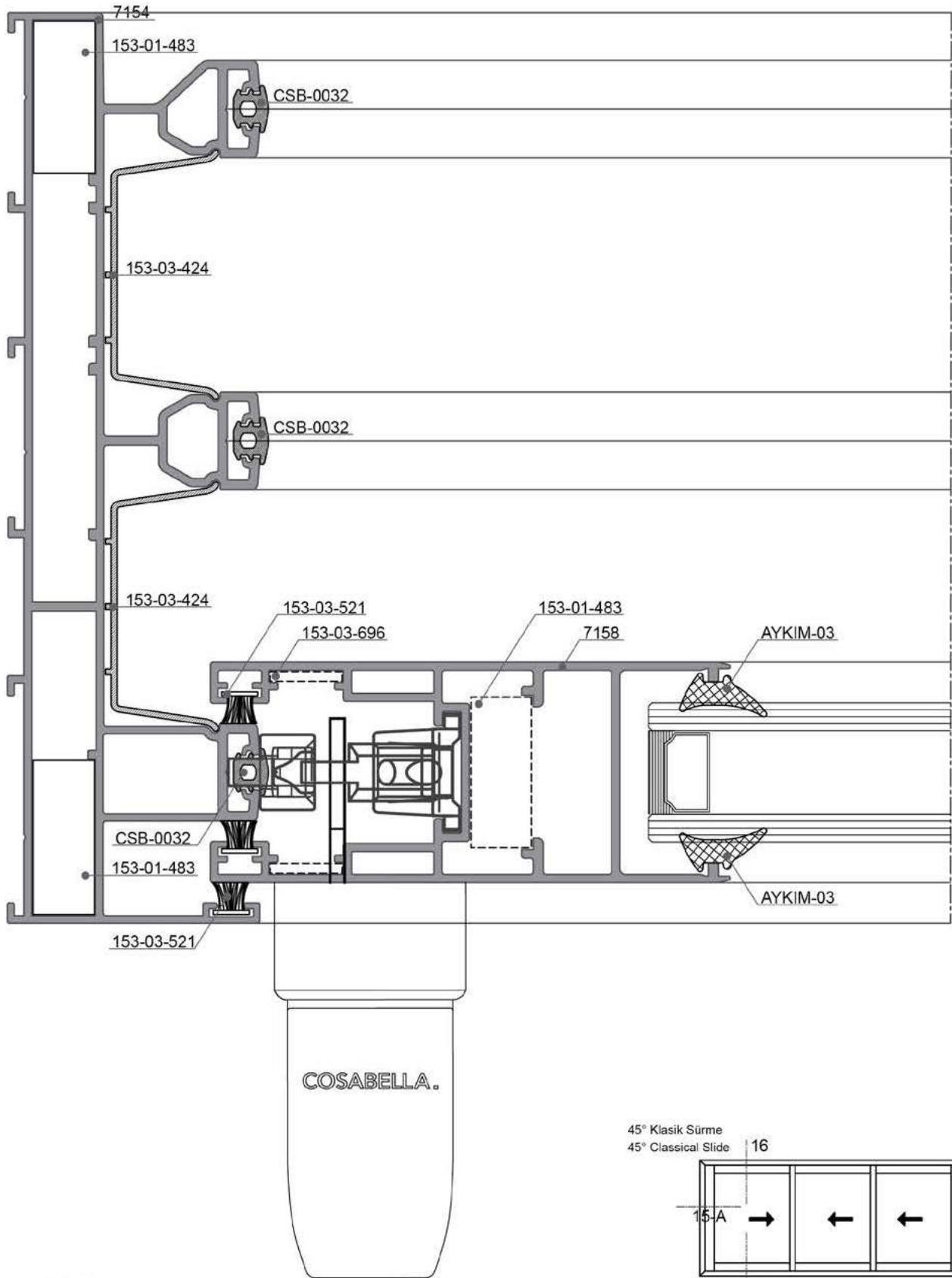
15-A DETAYI
DETAIL

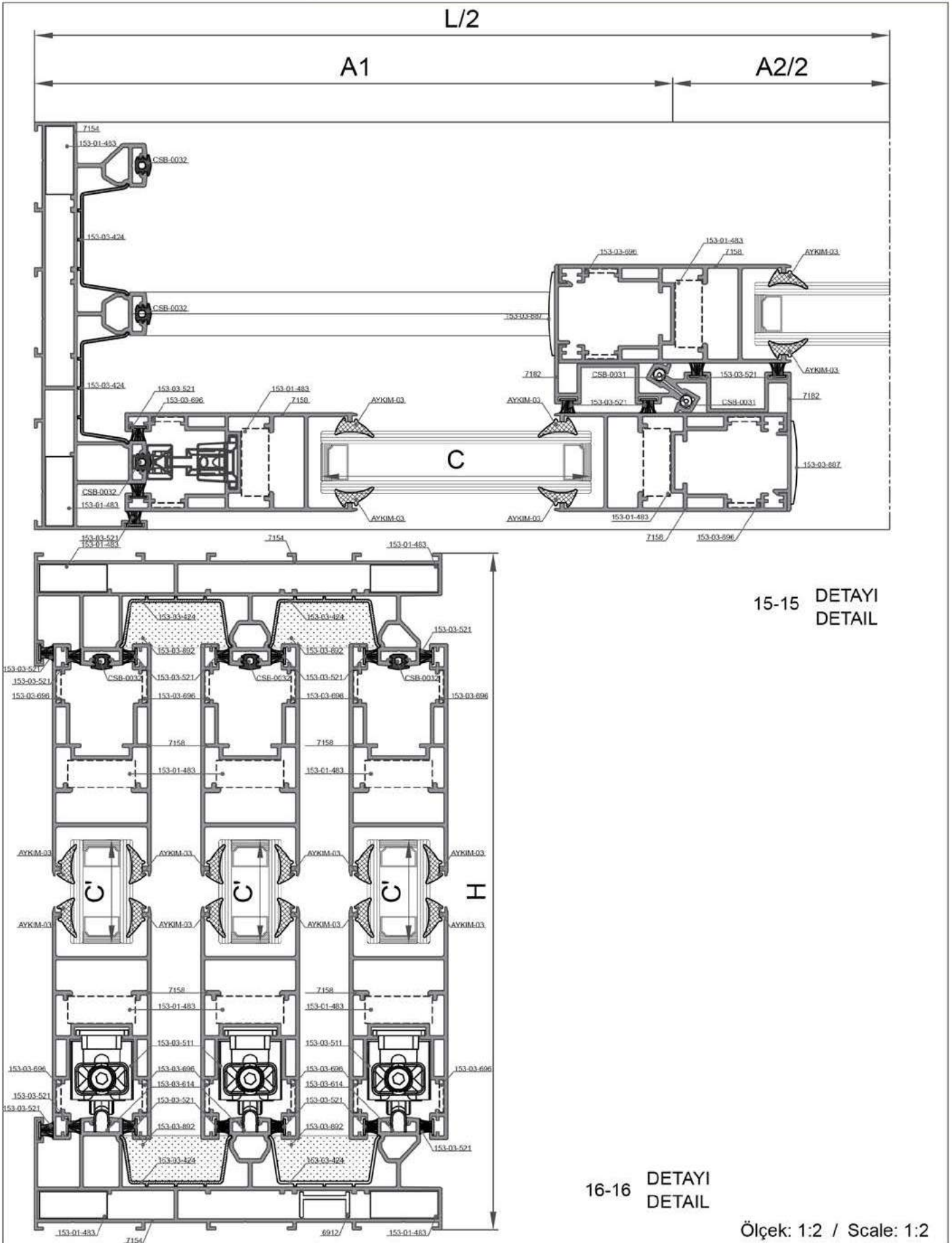

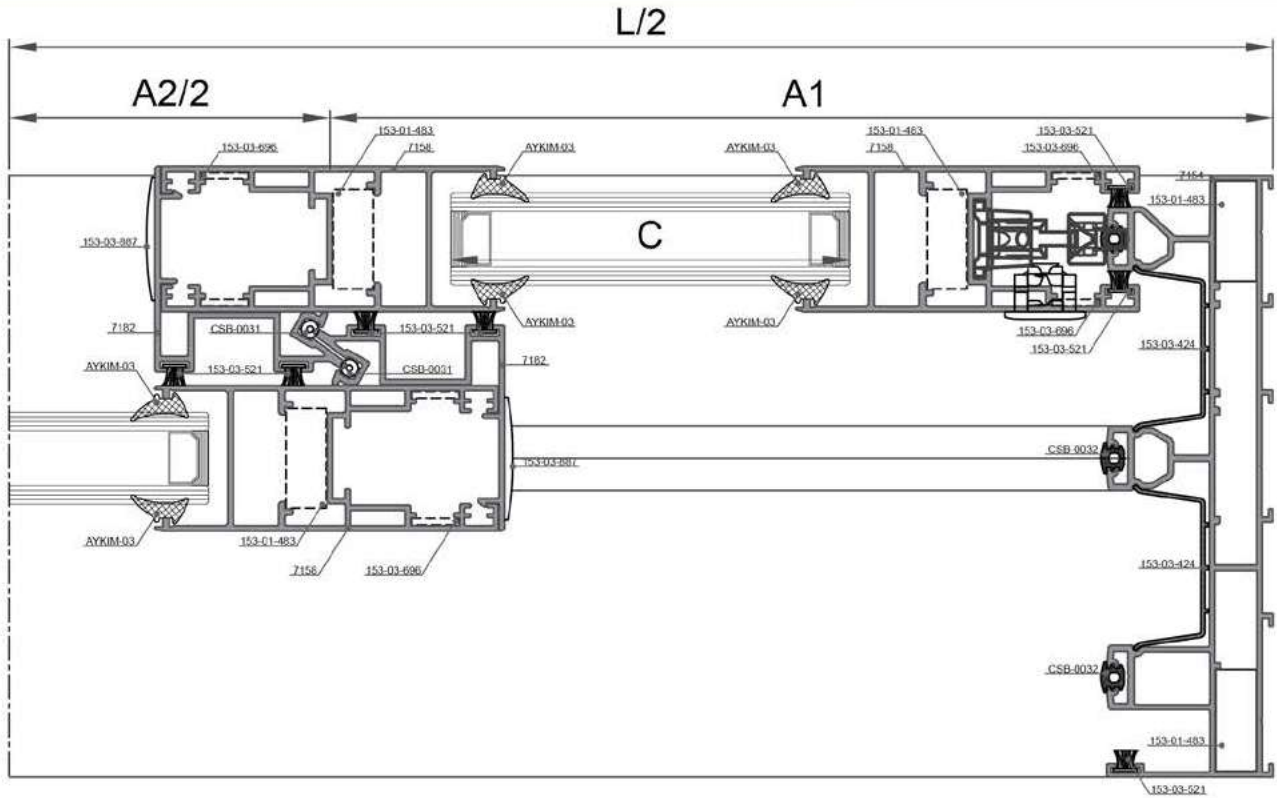

Kasa Genişlik Frame Width	6867-7006			2 Ad. 2 Pcs.	L
Kasa Yükseklik Frame Height	6867-7006			2 Ad. 2 Pcs.	H
Kanat Yükseklik Sash Height	7158			2 Ad. 2 Pcs.	H-70
Yatay Kanat Genişlik Horizontal Sash Width	7158			6 Ad. 6 Pcs.	A1+9,4
Kenet Kanat Yükseklik Sash Height	7182			1 Ad. 1 Pcs.	H-70
Kanat Cam Genişlik Glazing Sash Width				3 Ad. 3 Pcs.	A1-147,6
Kanat Cam Yükseklik Glazing Sash Height				3 Ad. 3 Pcs.	H-227
	153-01-483 Vidalı Köşe Bağ. Takozu Screwed Corner Cleat	24 Ad. 24 Pcs.		153-03-889 Stoplama Stoppage	6 Ad. 6 Pcs.
	153-03-511 Ayarlı Rulman Adjustable Roller	6 Ad. 6 Pcs.		153-03-424 Kanal "U" Plastik Plastic Cover For Frame	L-35,4 mm. 2 Ad./Pcs H-35,4 mm. 2 Ad./Pcs
	153-03-614 Paslanmaz Çelik Ray Stainless Steel Rail Track	L-75,04 mm. 3 Ad./Pcs.		153-03-521 67-650'lık Kumaş Fınlı Kıl Fıtlı Brush Pile Seal	14H+8L
	153-03-092 Kasa Alt & Üst Tozluk Central Top & Bottom Sealing	2 Tkm. 2 Set.		CSB-0032 Ray Kapama Contası Gasket For Frame Rails	6H+3L
	153-03-887 Adaptör Kapağı Alt & Üst Adapter Cap Bottom & Top	4 Tkm. 4 Set.		AYKIM-03 Glazing Wedge Gasket (Cam Tercihine Göre) (Optional Glass Size)	12C+12C'
	153-03-696 Kanat Köşe Gönye Alignment Square	24 Ad. 24 Pcs.		CSB-0031 Cosabella Kenet Fıtlı Cosabella Brush Pile Seal	Metre Meter 4 Ad. / Pcs H-75,48

15-15 DETAYI
DETAIL

45° Klasik Sürme

45° Classical Slide

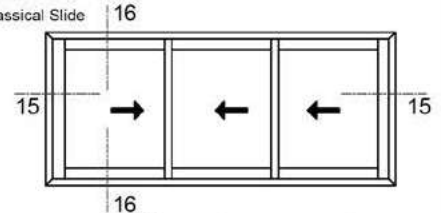

Ölçek: 1:2 / Scale: 1:2

Kesim ölçüsü - cam ölçüsü vb. sorumluluğu tarafımıza ait değildir.

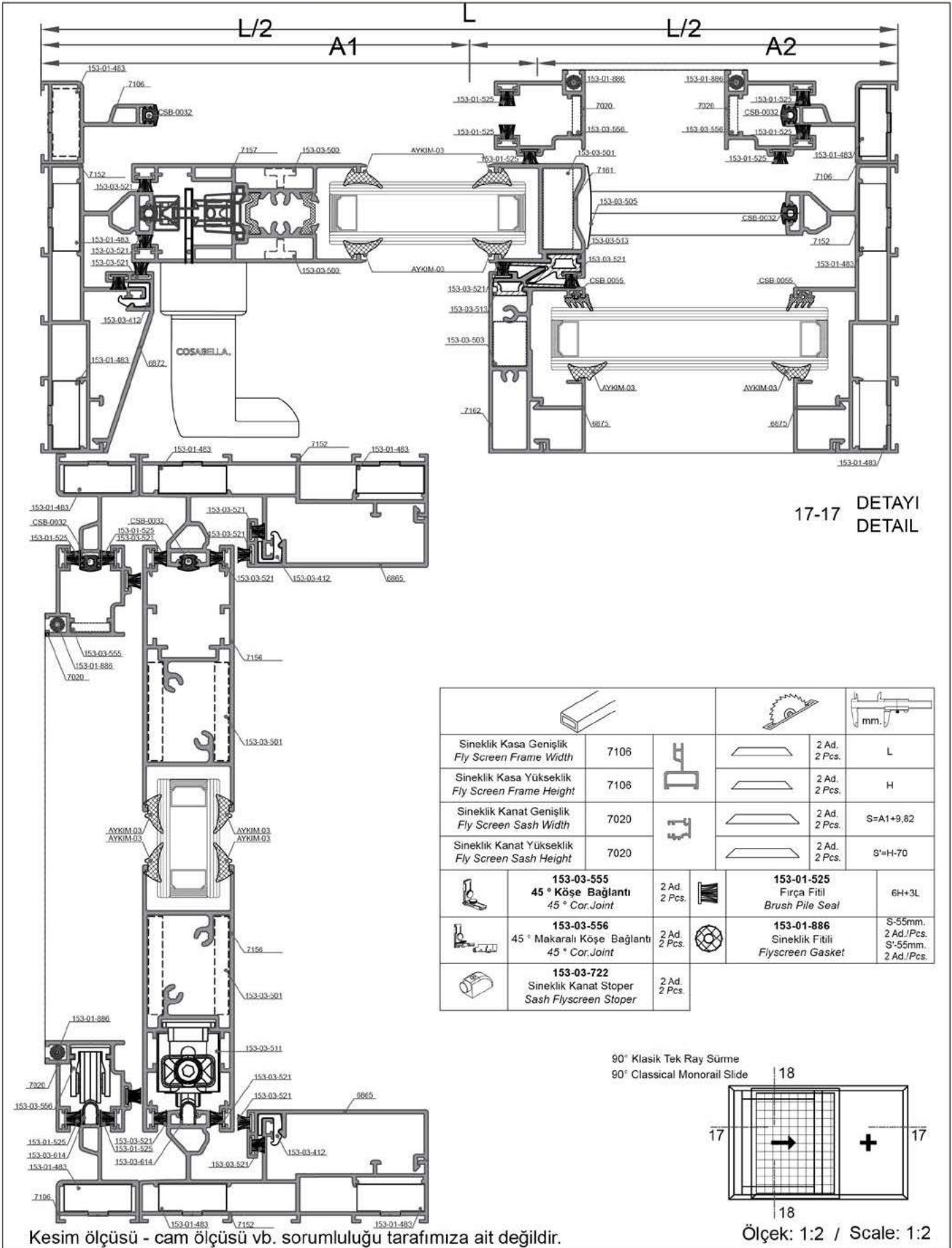

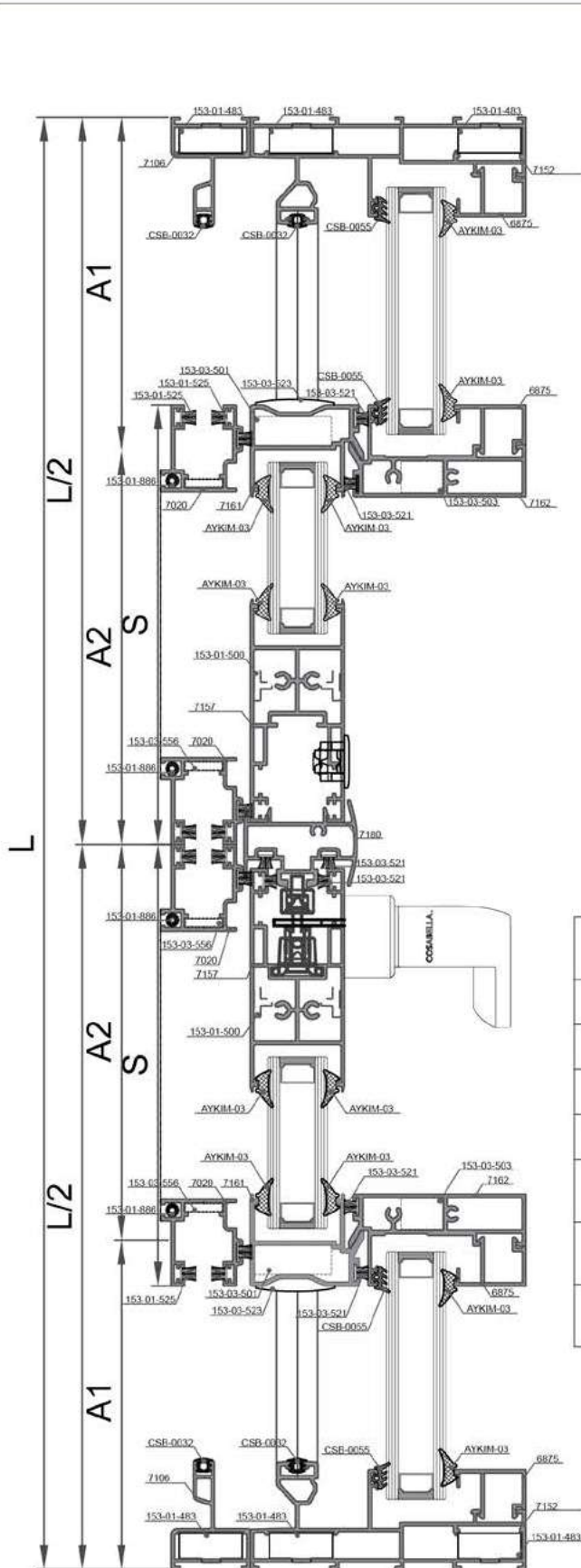
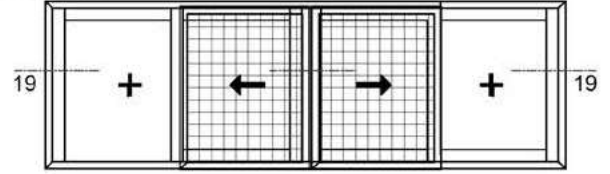
90° Klasik Sürme
90° Classical Slide

Sineklik Kasa Genişlik Fly Screen Frame Width	7106			2 Ad. 2 Pcs.	L
Sineklik Kasa Yükseklik Fly Screen Frame Height	7106			2 Ad. 2 Pcs.	H
Sineklik Kanat Genişlik Fly Screen Sash Width	7020			4 Ad. 4 Pcs.	S=L/2-16.49
Sineklik Kanat Yükseklik Fly Screen Sash Height	7020			4 Ad. 4 Pcs.	S'=H-70
	153-03-555 45° Köşe Bağlantı 45° Cor.Joint	4 Ad. 4 Pcs.		153-01-525 Fırça Fıtlı Brush Pile Seal	4H*2L
	153-03-556 45° Makaralı Köşe Bağlantı 45° Cor.Joint	4 Ad. 4 Pcs.		153-01-886 Sineklik Fıtlı Flyscreen Gasket	S-55mm. 2 Ad./Pcs. S'-55mm. 2 Ad./Pcs.
	153-03-722 Sineklik Kanat Stoper Sash Flyscreen Stoper	2 Ad. 2 Pcs.			

19-19 DETAYI
DETAIL

Kesim ölçüsü - cam ölçüsü vb. sorumluluğu tarafımıza ait değildir.

Çizimler Ölçeksizdir.

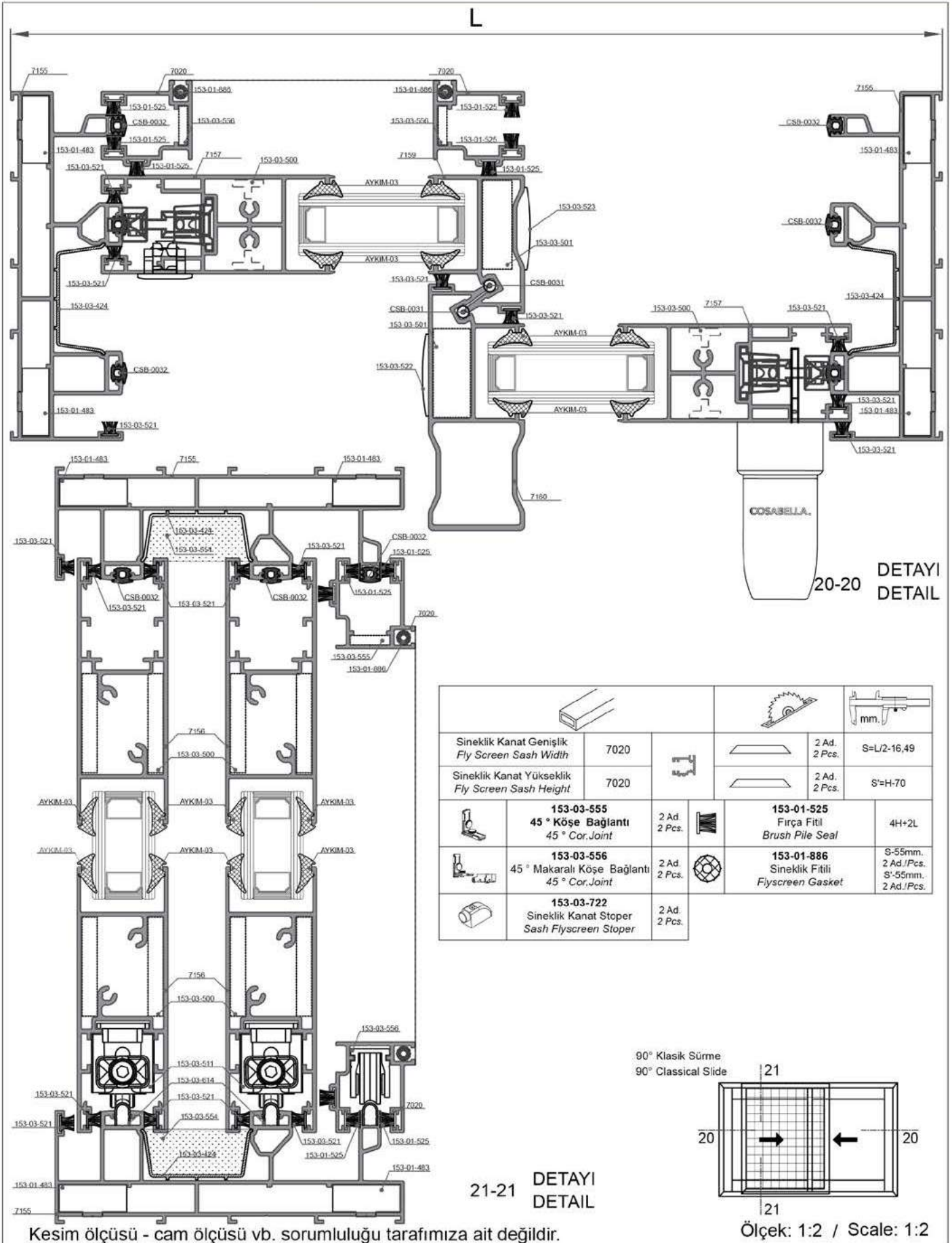

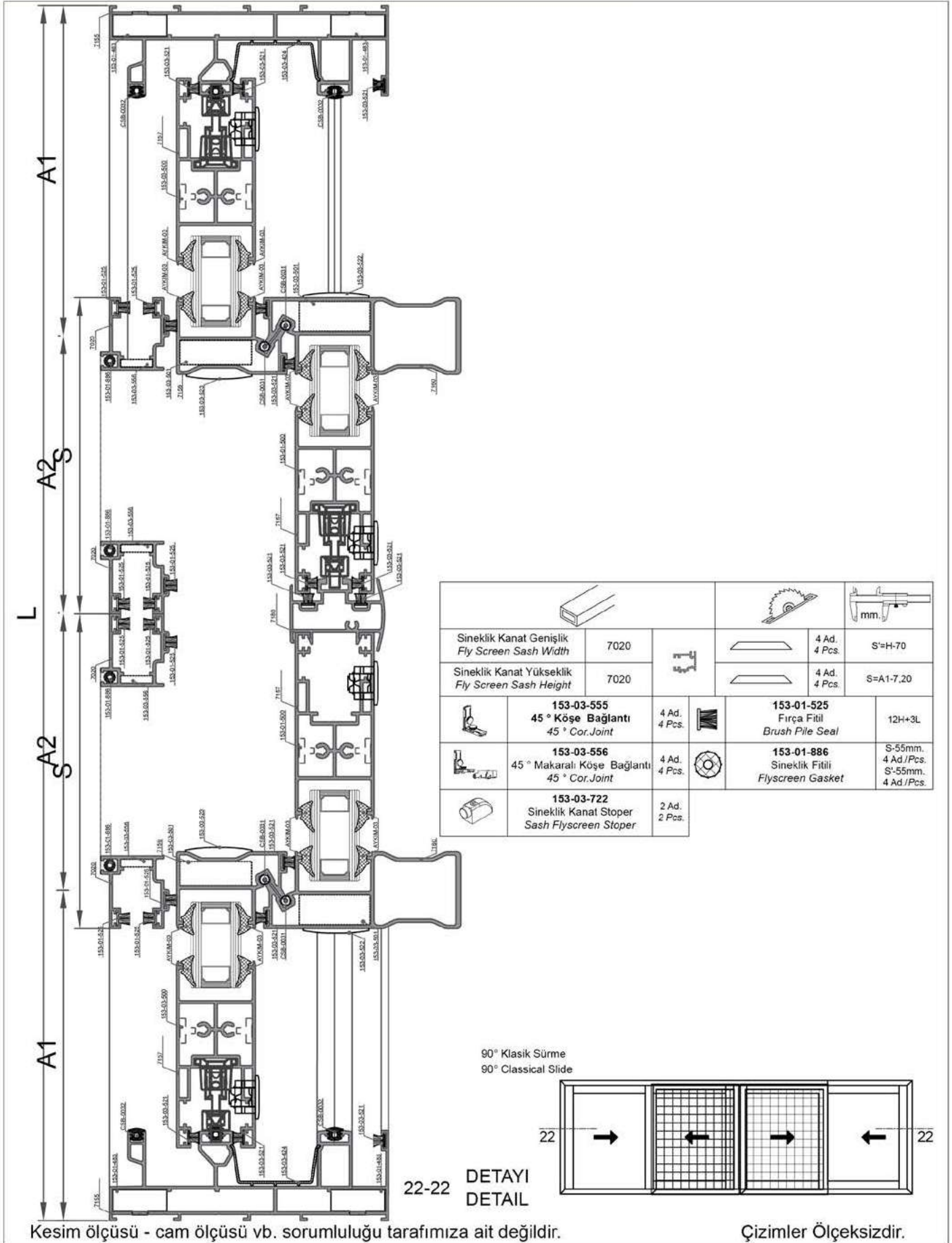

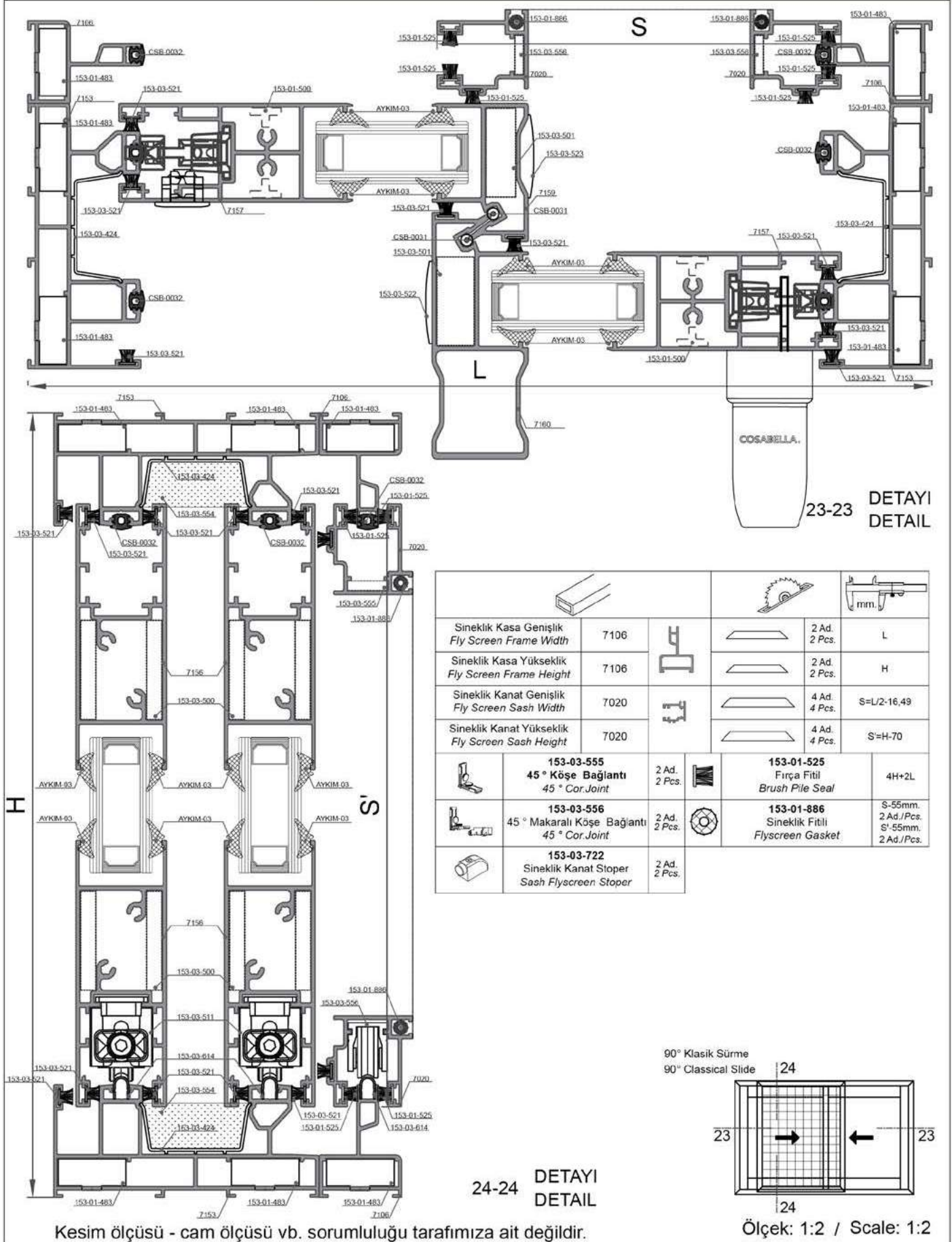

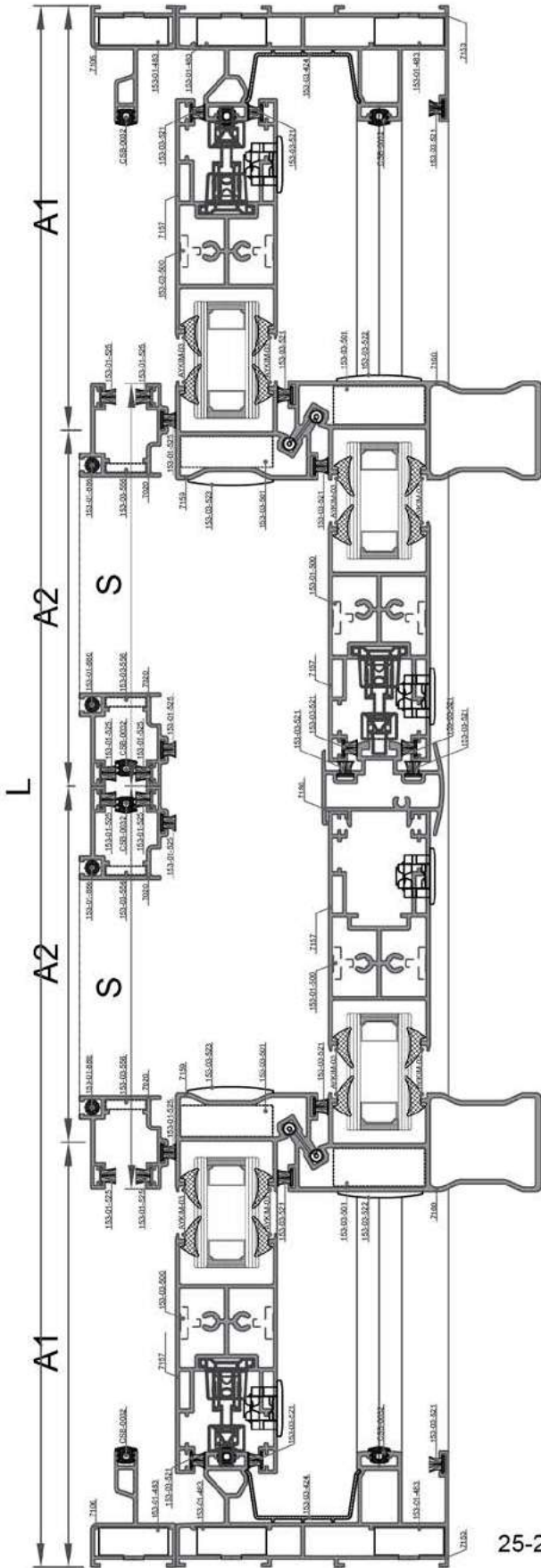

	Sineklik Kasa Genişlik Fly Screen Frame Width	7106			2 Ad. 2 Pcs.	L
	Sineklik Kasa Yükseklik Fly Screen Frame Height	7106			2 Ad. 2 Pcs.	H
	Sineklik Kanat Genişlik Fly Screen Sash Width	7020			4 Ad. 4 Pcs.	S=A2+18,5
	Sineklik Kanat Yükseklik Fly Screen Sash Height	7020			4 Ad. 4 Pcs.	S'=H-70
	153-03-555 45° Köşe Bağlantı 45° Cor.Joint	4 Ad. 4 Pcs.		153-01-525 Fırça Fitali Brush Pile Seal	12H+3L	
	153-03-556 45° Makaralı Köşe Bağlantı 45° Cor.Joint	4 Ad. 4 Pcs.		153-01-886 Sineklik Fitali Flyscreen Gasket	S-55mm. 4 Ad./Pcs. S'-55mm. 4 Ad./Pcs.	
	153-03-722 Sineklik Kanat Stoper Sash Flyscreen Stoper	2 Ad. 2 Pcs.				

90° Klasik Sürme
90° Classical Slide

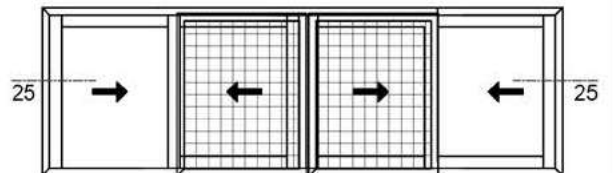







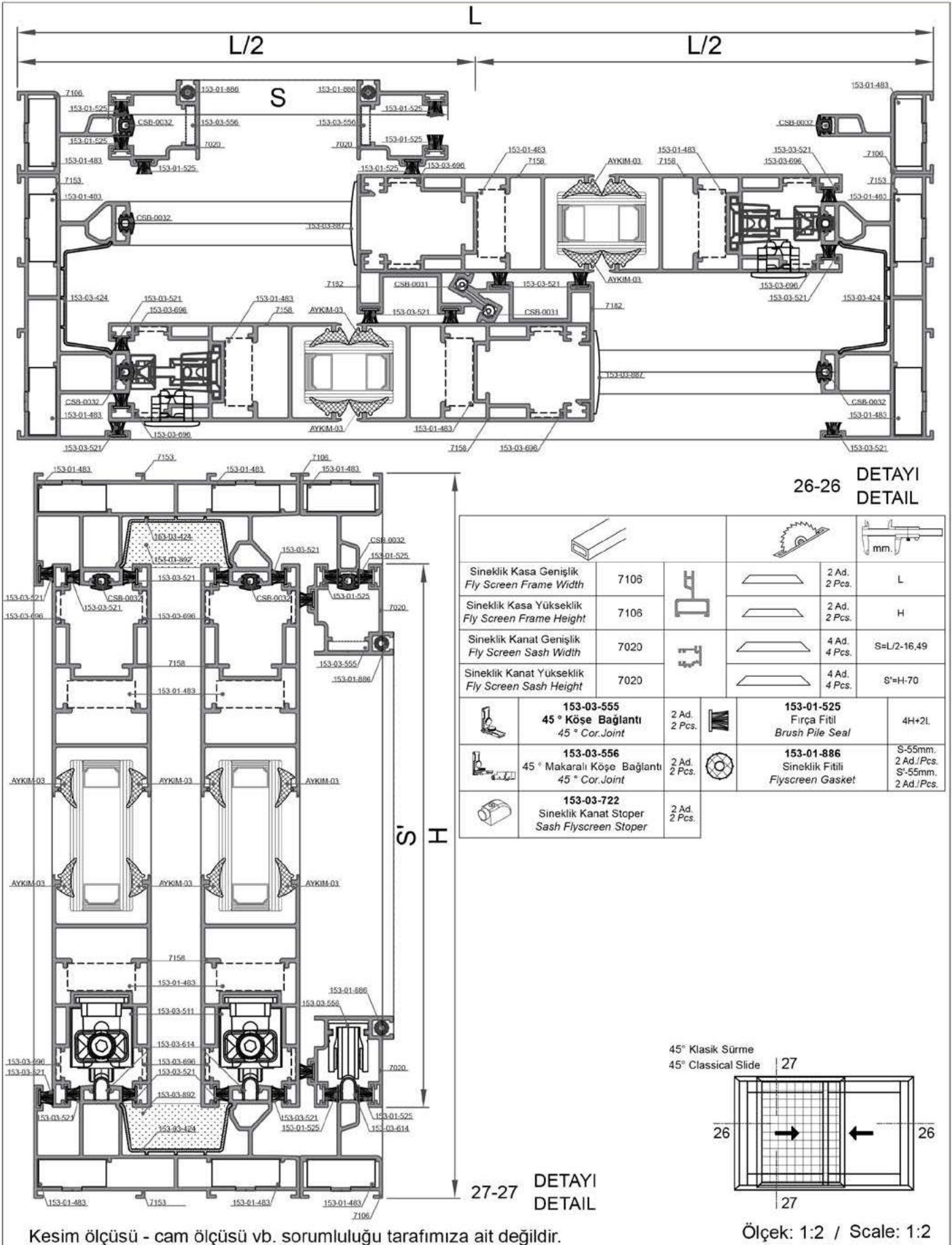

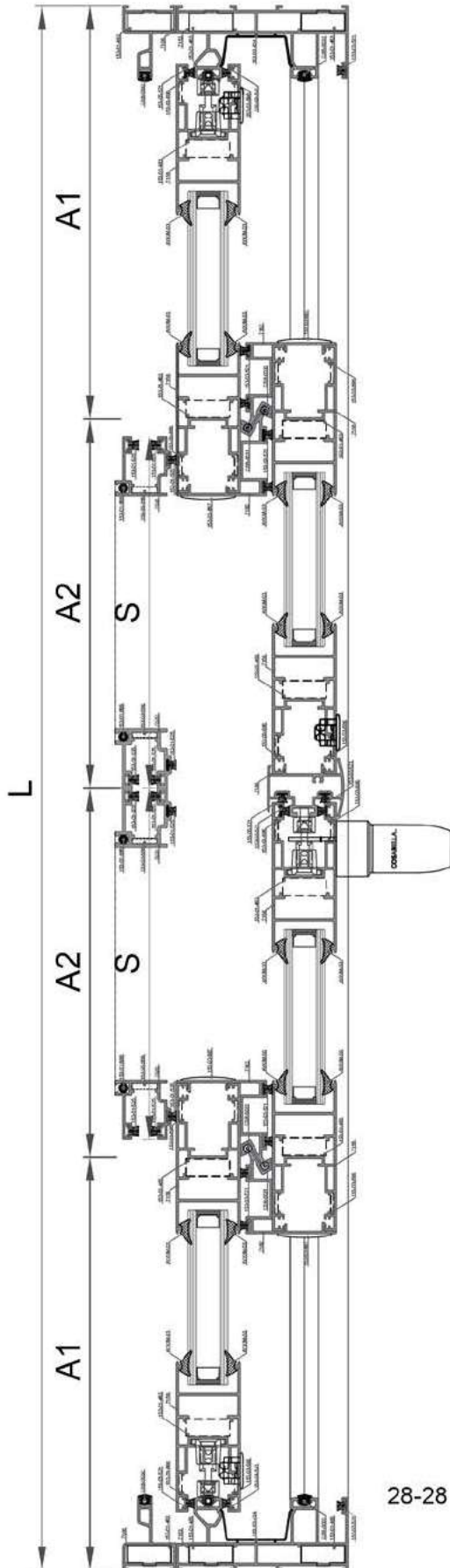



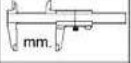

25-25
DETAYI
DETAIL

Kesim ölçüsü - cam ölçüsü vb. sorumluluğu tarafımıza ait değildir.

Çizimler Ölçeksizdir.





				
Sineklik Kasa Genişlik Fly Screen Frame Width	7106		2 Ad. 2 Pcs.	L
Sineklik Kasa Yükseklik Fly Screen Frame Height	7106		2 Ad. 2 Pcs.	H
Sineklik Kanat Genişlik Fly Screen Sash Width	7020		4 Ad. 4 Pcs.	S=A1-7,20
Sineklik Kanat Yükseklik Fly Screen Sash Height	7020		4 Ad. 4 Pcs.	S'=H-70
	153-03-555 45° Köşe Bağlantı 45° Cor.Joint	4 Ad. 4 Pcs.		153-01-525 Fırça Fıtlı Brush Pile Seal
	153-03-556 45° Makaralı Köşe Bağlantı 45° Cor.Joint	4 Ad. 4 Pcs.		153-01-886 Sineklik Fıtlı Flyscreen Gasket
	153-03-722 Sineklik Kanat Stoper Sash Flyscreen Stoper	2 Ad. 2 Pcs.		S-55mm. 4 Ad./Pcs. S'-55mm. 4 Ad./Pcs.

45° Klasik Süme
45 Classical Slide

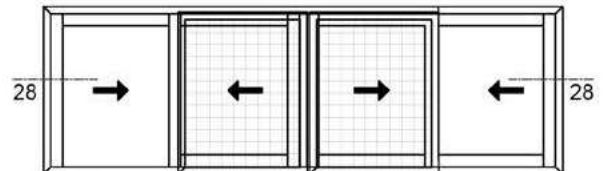

28-28 DETAYI
DETAIL

Kesim ölçüsü - cam ölçüsü vb. sorumluluğu tarafımıza ait değildir.
Çizimler Ölçeksizdir.

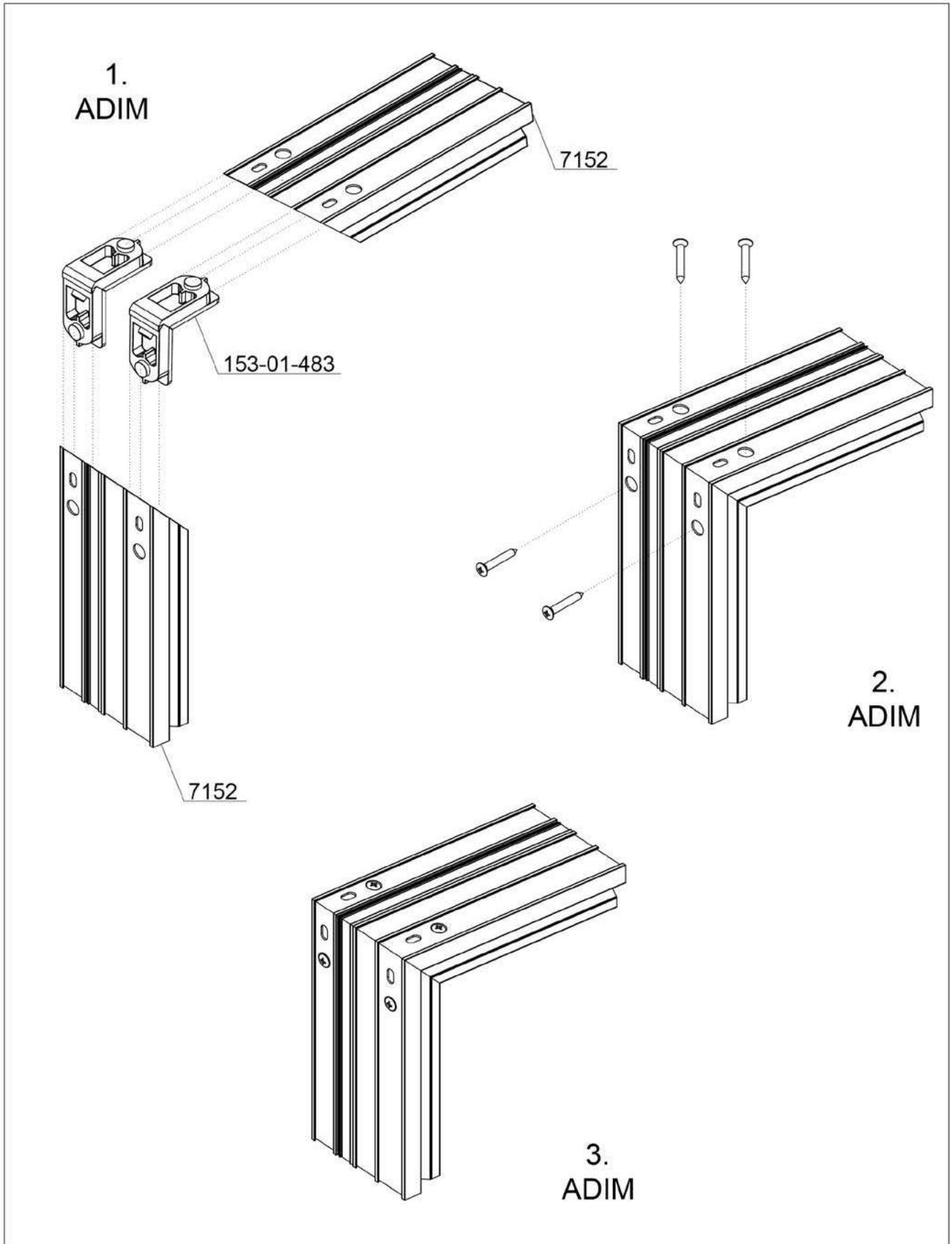

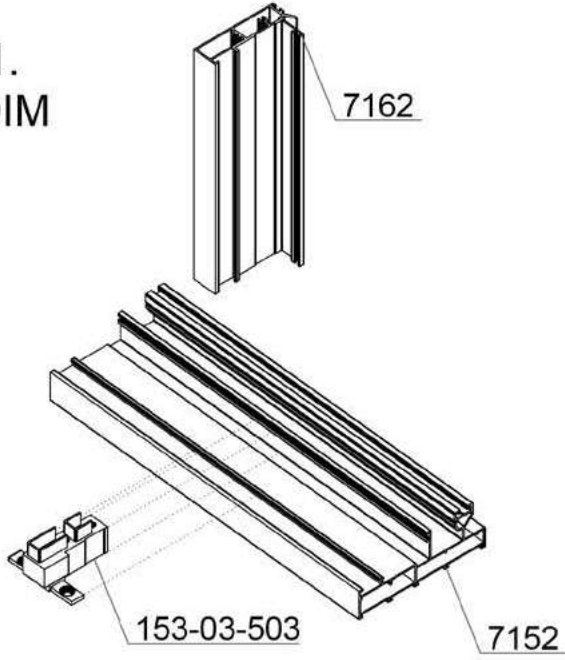
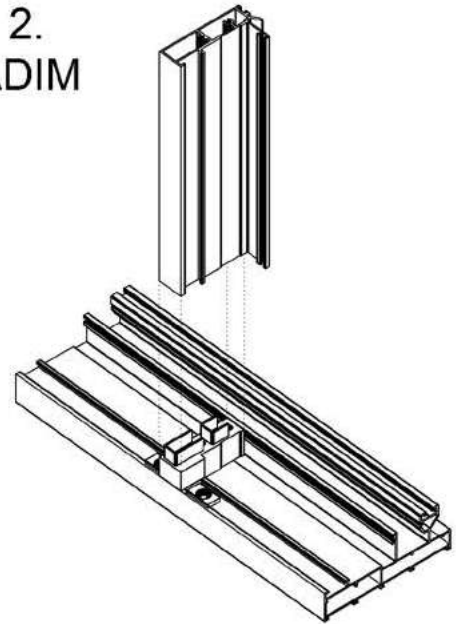
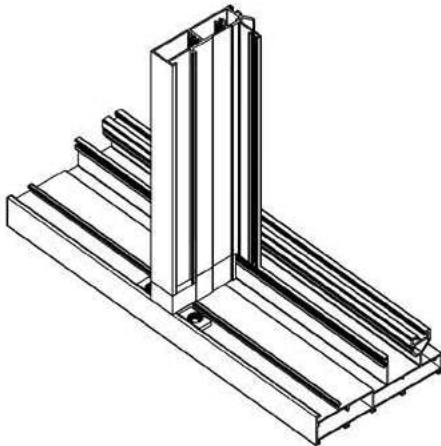
1.
ADIM2.
ADIM3.
ADIM

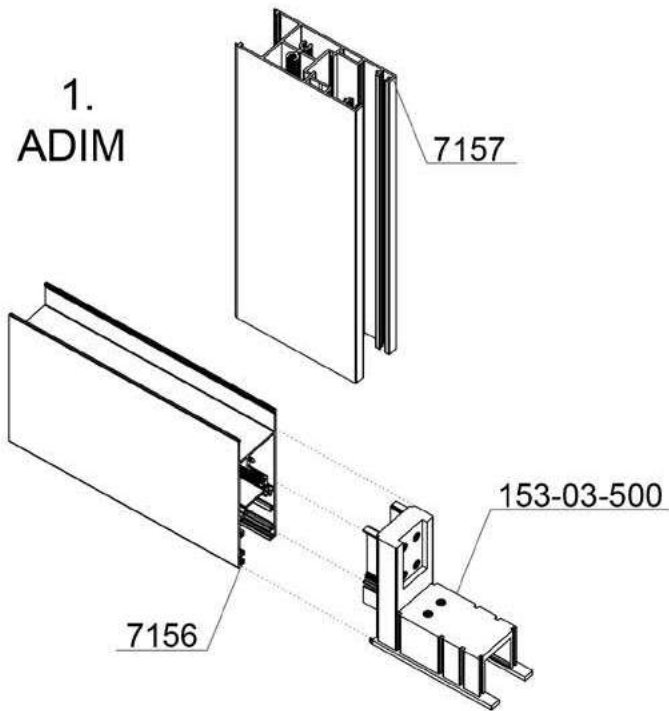
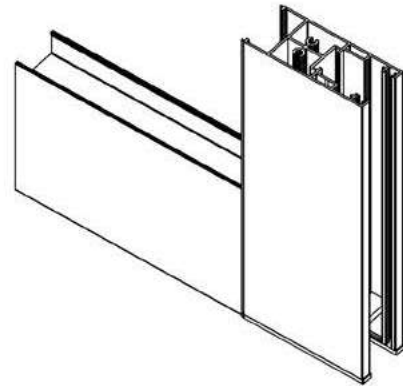
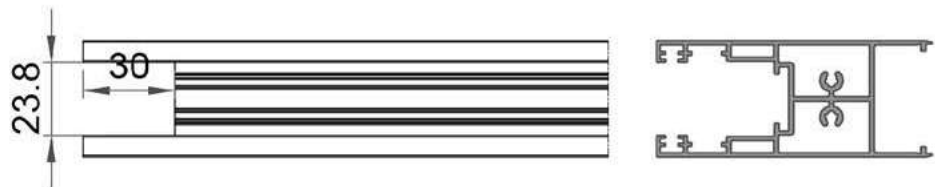
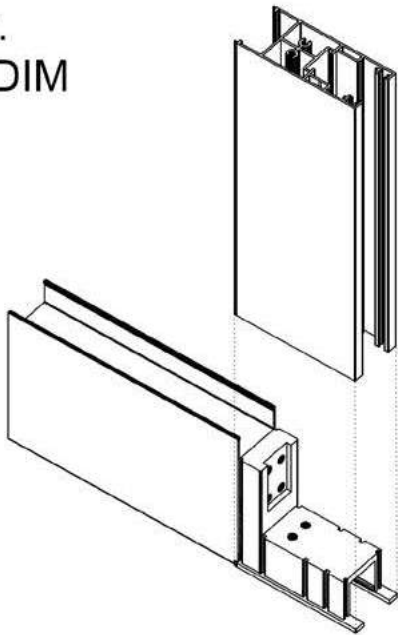
1.
 ADIM

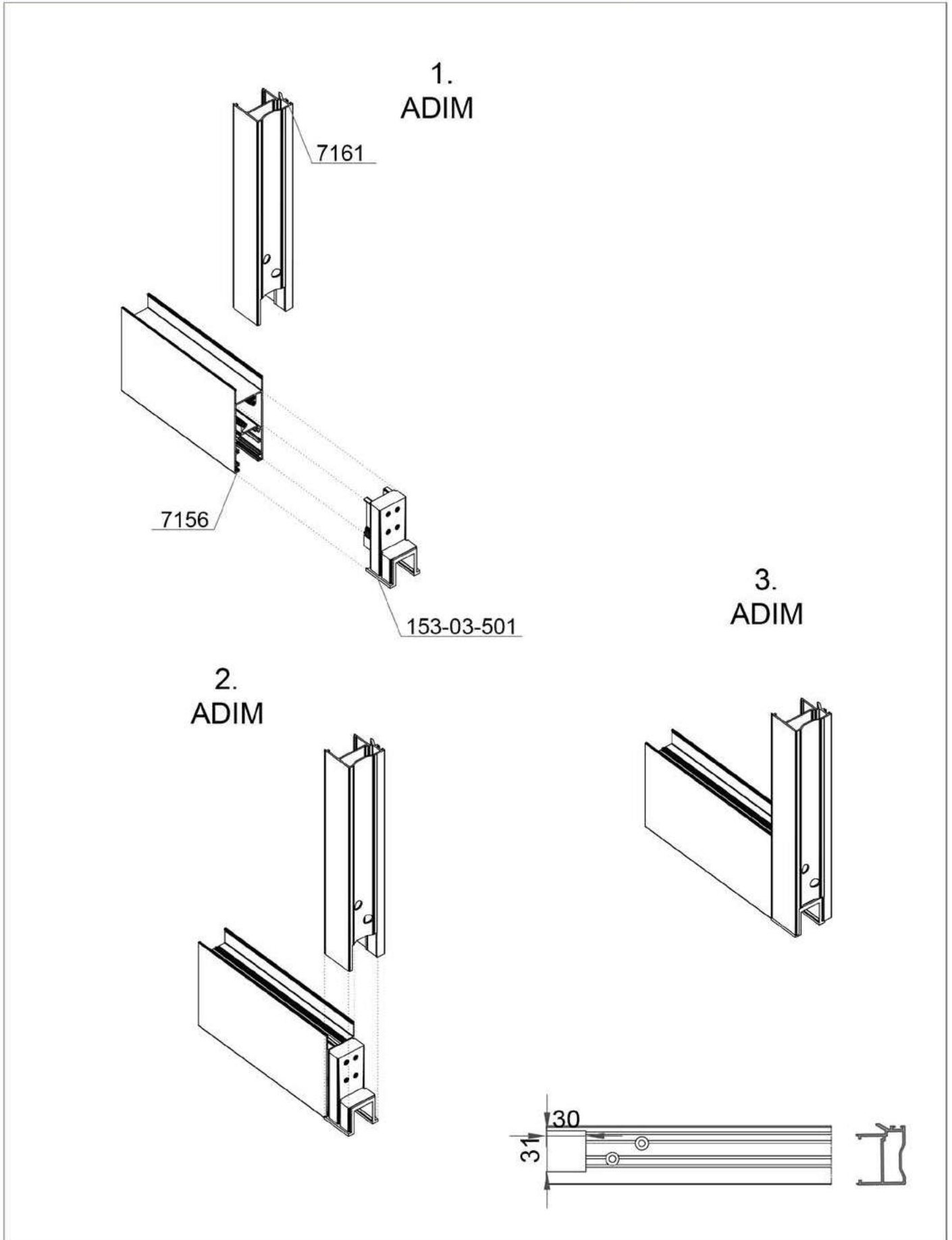
 3.
 ADIM

 2.
 ADIM

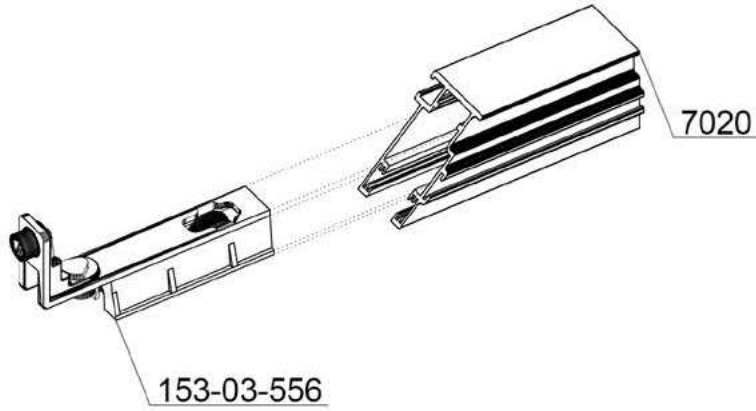
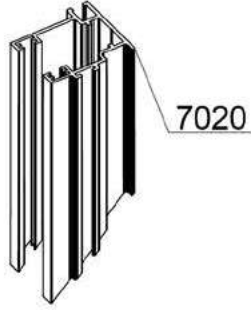

1.
ADIM

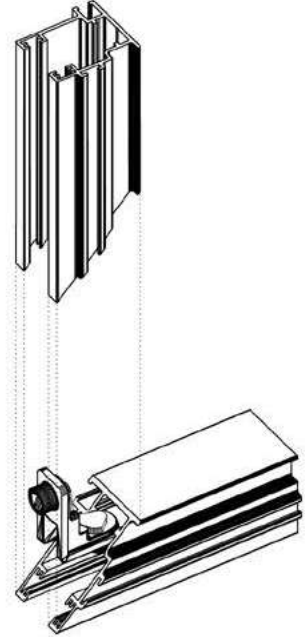







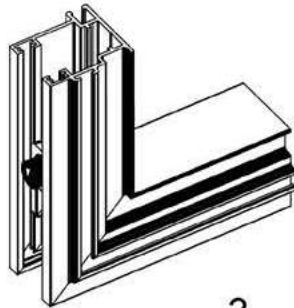



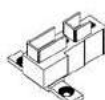

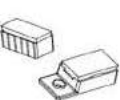
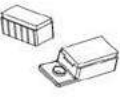





2.
ADIM

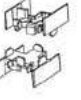













3.
ADIM



Ürün Çizimi Drawing	Ürün Kodu Product No	Ürün Adı Product Name	Kullanıldığı Profiller Profiles Used
	153-01-483	Kasa Bağlantı Takozu 11/26 <i>Joint Corner</i>	7152 7153 7155 7154
	153-03-500	90 ° Geniş Köşe Bağlantı Takozu <i>90 ° Wide Sash Cor.Joint</i>	7157 7156
	153-03-501	90 ° Dar Köşe Bağlantı Takozu <i>90 ° Narrow Sash Cor.Joint</i>	7159 / 7160 7161 / 7156
	153-03-503	90 ° Dar Köşe Bağlantı Takozu <i>90 ° Narrow Sash Cor.Joint</i>	7162 7152
	153-03-696	Kanat Köşe Gönye <i>Alignment Square</i>	-
	153-03-504	Kasa Alt & Üst Tozluk <i>Central Top & Bottom Sealing</i>	-
	153-03-554	Kasa Alt & Üst Tozluk <i>Central Top & Bottom Sealing</i>	-
	153-03-892	45°Kasa Alt & Üst Tozluk <i>Central Top & Bottom Sealing</i>	-
	153-03-505	Adaptör Kapağı Alt & Üst <i>Adapter Cap Bottom & Top</i>	7161
	153-03-522	Takviyeli Adaptör Kapağı Alt & Üst <i>Adapter Cap Bottom & Top</i>	7160
	153-03-523	Takviyesiz Adaptör Kapağı Alt & Üst <i>Adapter Cap Bottom & Top</i>	7159
	153-03-887	45°Adaptör Kapağı Alt & Üst <i>Adapter Cap Bottom & Top</i>	







Ürün Çizimi Drawing	Ürün Kodu Product No	Ürün Adı Product Name	Kullanıldığı Profiller Profiles Used
	153-03-506	SD-33 Kenetli Alt - Üst Kulp Kapağı SD-33 Sash Bottom & Top Cap	-
	153-03-507	4'lü Kanat Adaptör Kapağı 4 Winged Lid	-
	153-03-408	Stoplama Stoppage	-
	153-03-424	Kanal "U" Plastiği Plastic Cover For Frame	-
	153-03-614	Paslanmaz Çelik Ray Stainless Steel Rail Track	-
	153-03-511	Ayarlı Rulman Adjustable Roller	-
	153-03-412	Adaptör Kenetleme Klipsi Plastic Lock Clips	-
	153-03-509	Sabitleme Takoza Fixing Wedge	- -
	153-03-510	Sabitleme Aparatı Fixing Device	- -
	153-01-356	Polyamid Tij Polyamide Tij	-



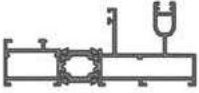
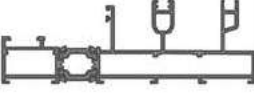

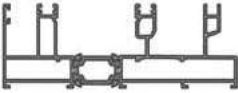
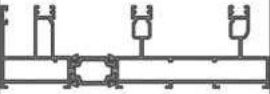
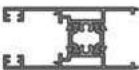
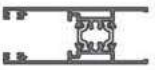
Ürün Çizimi Drawing	Ürün Kodu Product No	Ürün Adı Product Name	Kullanıldığı Profiller Profiles Used
	153-03-412	Tijli Sistem Karşılığı <i>Equipment For Tiji System</i>	-
	153-03-420	COSABELLA Kilitleme Parçası <i>COSABELLA Locking Part</i>	-
	153-03-986	Stac Eksenel Kol <i>Spades Handle</i> 986-Siyah 986-Black	-
	153-03-479	Stac Kıvrık Eksenel Kol Sol <i>Spades Handle</i> 478-Siyah 478-Black	-
	153-03-478	Stac Kıvrık Eksenel Kol Sağ <i>Spades Handle</i> 479-Siyah 479-Black	-
	153-03-317	Tijli Gömme Kilit Pimi <i>Tij Mixed Lock Pin</i>	-
	153-03-802 153-03-813 153-03-815	Tijli Gömme Kilit <i>Mixed Lock With Hinge</i> 802- renkli, 813- Eloksal, 815- Beyaz 802- Color, 813- Silver, 815- White	-
	153-03-801 153-03-812 153-03-814	Tijli Gömme Kilit Karşılığı 801- renkli, 812- Eloksal, 814- Beyaz 801- Color, 812- Silver, 814- White	-
	153-02-789	Tahliye Tapası <i>Drain Plug</i>	-
	153-03-722	Sineklik Kanat Stoper <i>Sash Flyscreen Stoper</i>	-
	153-03-555	45° Köşe Bağlantı Takoza <i>45° Corner Joint</i>	-
	153-03-556	45° Makaralı Köşe Bağlantı Takoza <i>45° Corner Joint</i>	- -

Ürün Çizimi Drawing	Ürün Kodu Product No	Ürün Adı Product Name	Kullanıldığı Profiller Profiles Used
	153-01-525	Fırça Fitol <i>Brush Pile Seal</i>	-
	153-03-521	67-650'lik Kumaş Finli Kıl Fitol <i>Brush Pile Seal</i>	-
	CSB-0032	Ray Kapama Contası <i>Gasket For Frame Rails</i>	-
	153-01-886	Sineklik Fitol <i>Flyscreen Gasket</i>	-
	CSB-0055	Dış Cam Contası <i>External Glass Gasket</i>	-
	AYKIM-03	Glazing Wedge Gasket <i>(Cam Tercihine Göre) (Optional Glass Size)</i>	-

SD22
SD23
SD32
SD33
SD35
WD42
WD52
FS72

SD32

Profil Profile	Profil Kodu Profile Nr	Ağırlık (kg/m.) Weight (kg/m.)	X mm.	Y mm.	Jx cm ⁴	Jy cm ⁴
	6788-6787 Tekli Kasa Profili Frame Profile	1,534 kg/m	99,7 mm	43,5 mm	49,53	6,70
	6788-6909 Sineklikli Tekli Kasa Profili Frame Profile	1,970 kg/m	131,6	43,5 mm	112	96
	6785-6786 Sürme Kasa Prof. Frame Profile	1,540 kg/m	90,2 mm	43,5 mm	45,06	9,68
	6785-6913 Sineklikli Kasa Pr. Frame Profile	1,995 kg/m	122,1 mm	43,5 mm	101,17	11,51
	6785-6910 Üçlü Kasa Profili Frame Profile	2,170 kg/m	141,4 mm	43,5 mm	152,8	13,23
	6780-6780 Kilit Kanat Profili Sash Profile	1,201 kg/m	75 mm	29 mm	15,39	5,36
	6784-6784 Yatay Kanat Pr. Sash Profile	1,230 kg/m	70 mm	32 mm	14,28	6,53
	6791 Takviyeli Kenet Kanat Profili Sash Profile	0,955 kg/m	82,7 mm	20 mm	25,03	1,40
	6781 Kenet Kanat Pr. Sash Profile	0,479 kg/m	20 mm	47,7 mm	4,40	0,55
	6789 Orta Kayıt Profili Middle Transom Pr.	0,785 kg/m	29 mm	64,2 mm	10,66	1,11
	6790 Kenet Kanat Pr. Sash Profile	0,538 kg/m	29 mm	38 mm	3,14	1,41

Profil Profile	Profil Kodu Profile Nr	Ağırlık (kg/m.) Weight (kg/m.)	X mm.	Y mm.	Jx cm ⁴	Jy cm ⁴
	6915-6916 Kilitleme Profili Adapter Profile	0,920 kg/m	35,21 mm	39,36 mm	4,55	2,39
	6782 Adaptör Profili Adapter Profile	0,446 kg/m	23,57 mm	64,2 mm	-	-
	6783 Adaptör Profili Adapter Profile	0,514 kg/m	64,2 mm	23,6 mm	-	-
	6875 Cam Çıta Profili Glazing Bread Pr.	0,271 kg/m	29 mm	19,86 mm	-	-
	7020 Sineklik Profili Fly Screen Profile	0,532 kg/m	30,55 mm	35 mm	-	-

Sürme Tekli Kasa Profili - Sliding Frame Profile

6788-6787

1,534 kg/mt

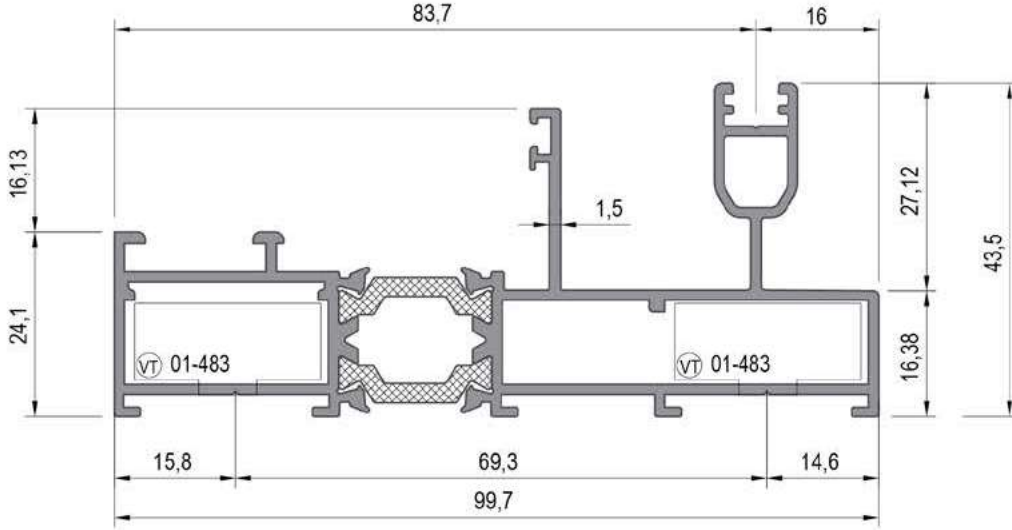

6788-6787

Kod/Code	Et Kalın./Wall Thk.	Ürün Adı / Prod. Name	Ağırlığı / Weight	Köşe Takozu / C. Cleat
6788-6787	1,5 mm	Tekli Kasa Profili / Single Frame Profile	1,534 kg/mt	153-01-483

Sineklikli Tekli Kasa Profili- Sliding Frame Profiles

6788-6909

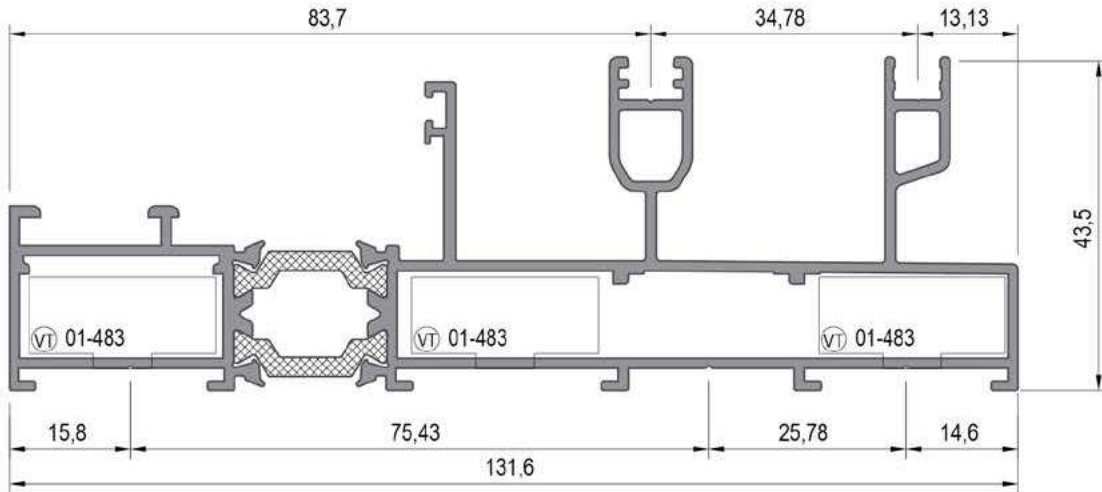
1,970 kg/mt



6788-6909

Kod/Code	Et Kalın./Wall Thk.	Ürün Adı / Prod. Name	Ağırlığı / Weight	Köşe Takozu / C. Cleat
6788-6909	1,3 mm	Tekli Sineklikli Kasa Pr. / Single Fly Screen Frame Pr.	1,970 kg/mt	153-01-483

Sürme Kasa Profili - Frame Profile

6785-6786

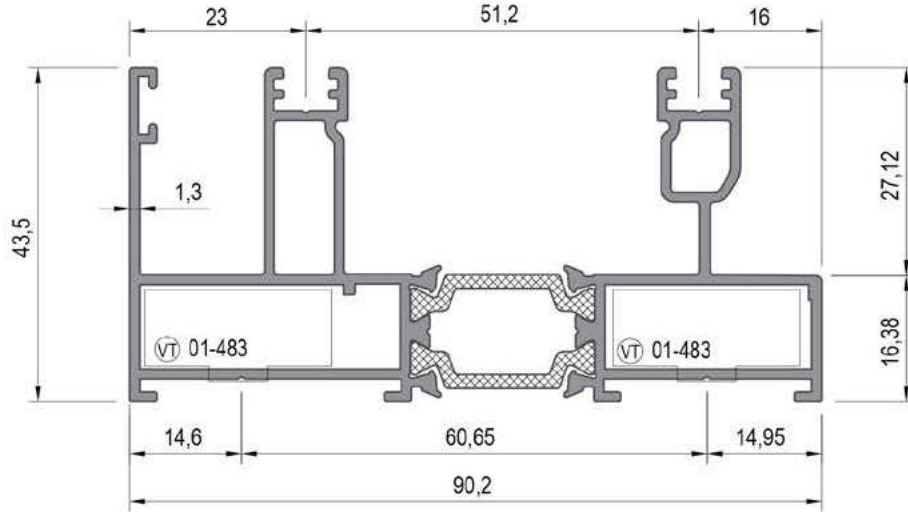
1,540 kg/mt



6785-6786

Kod/Code	Et Kalın./Wall Thk.	Ürün Adı / Prod. Name	Ağırlığı / Weight	Köşe Takozu / C. Cleat
6785-6786	1,4 mm	Sürme Kasa Pr. / Sliding Frame Pr.	1,540 kg/mt	153-01-483

Sineklikli Kasa Profili - Sliding Frame Profile

6785-6913

1,995 kg/mt

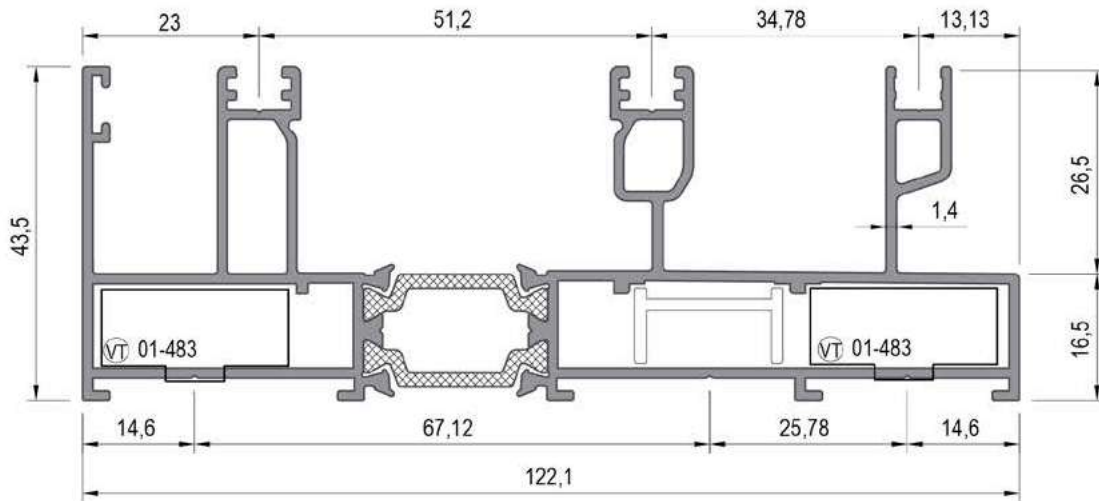

6785-6913

Kod/Code	Et Kalın./Wall Thk.	Ürün Adı / Prod. Name	Ağırlığı / Weight	Köşe Takozu / C. Cleat
6785-6913	1,3 mm	Sineklikli Kasa Pr./Fly Screen Frame Pr.	1,995 kg/mt	153-01-483

Üçlü Sürme Kasa Profili - Sliding Frame Profile

6785-6910

2,170 kg/mt

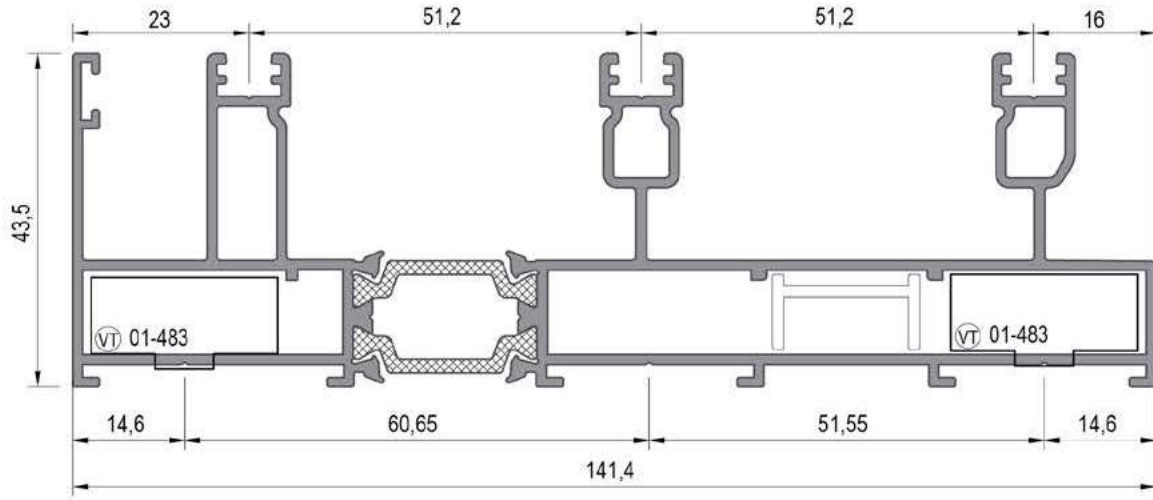

6785-6910

Kod/Code	Et Kalın./Wall Thk.	Ürün Adı / Prod. Name	Ağırlığı / Weight	Köşe Takozu / C. Cleat
6785-6910	1,3 mm	Üçlü Kasa Profili / Triple Frame Pr.	2,170 kg/mt	153-01-483

Orta Kilitleme Profili - Center Locking Profile

6915-6916

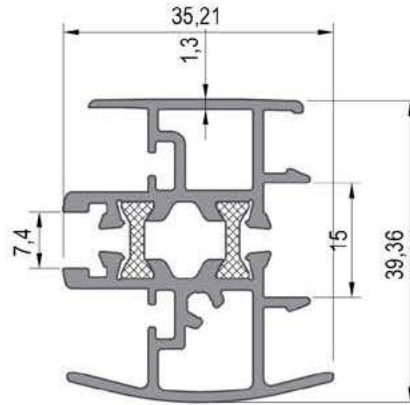
0,920 kg/mt



6915-6916

Kod/Code	Et Kalın./Wall Thk.	Ürün Adı / Prod. Name	Ağırlığı / Weight	Köşe Takozu / C. Cleat
6915-6916	1,3 mm	Kilitleme Profili / Center Locking Pr.	0,920 kg/mt	-

Kilit Kanat Profili - Sash Profile

6784-6784

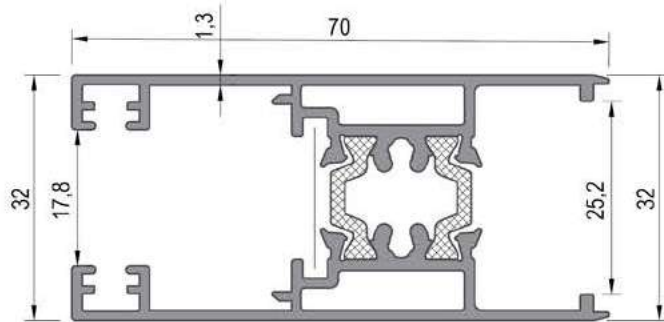
1,230 kg/mt



6784-6784

Kod/Code	Et Kalın./Wall Thk.	Ürün Adı / Prod. Name	Ağırlığı / Weight	Köşe Takozu / C. Cleat
6784-6784	1,3 mm	Kilit Kanat Profili / Locking Sash Pr.	1,230 kg/mt	-

Yatay Kanat Profili - Horizontal Sash Profile

6780-6780

1,201 kg/mt

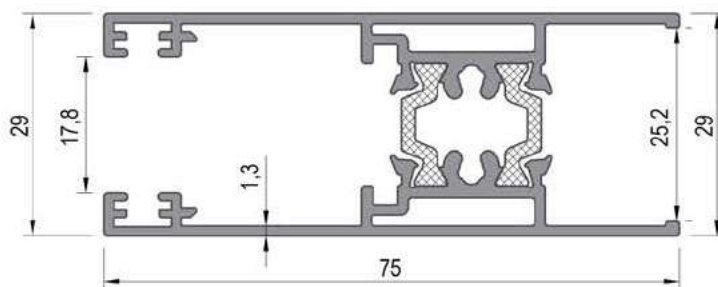

6780-6780

Kod/Code	Et Kalın./Wall Thk.	Ürün Adı / Prod. Name	Ağırlığı / Weight	Köşe Takozu / C. Cleat
6780-6780	1,3 mm	Yatay Kanat Pr. / Horizontal Sash Pr.	1,201 kg/mt	-

Takviyeli Kenet Kanat Profili - Sash Profile

6791

0,955 kg/mt

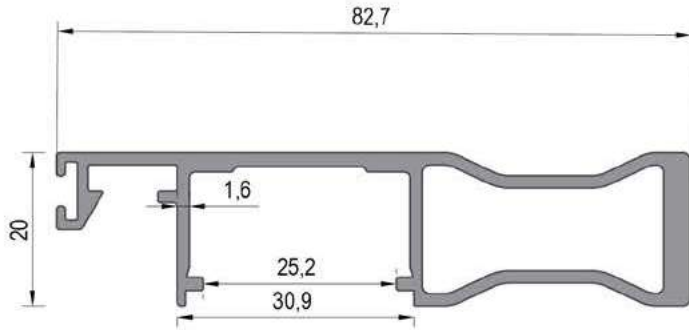

6791

Takviyesiz Kenet Kanat Profili - Sash Profile

6781

0,479 kg/mt

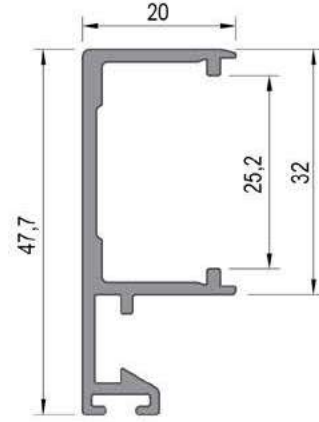

6781

Kod/Code	Et Kalın./Wall Thk.	Ürün Adı / Prod. Name	Ağırlığı / Weight	Köşe Takoğu / C. Cleat
6791	1,6 mm	Takviyeli Kanat / Reinforced Sash Pr.	0,955 kg/mt	-
6781	1,3 mm	Takviyesiz Kanat / Non-Reinforced Sash Pr.	0,479 kg/mt	-

Kenet Kanat Profili - Sash Profili

6790

0,538 kg/mt

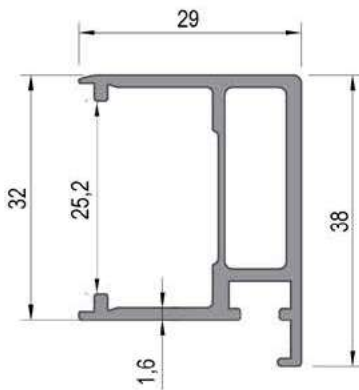

6790

Tekli Kasa Orta Kayıt Profili - Single Frame Middle Transom Profile

6789

0,785 kg/mt

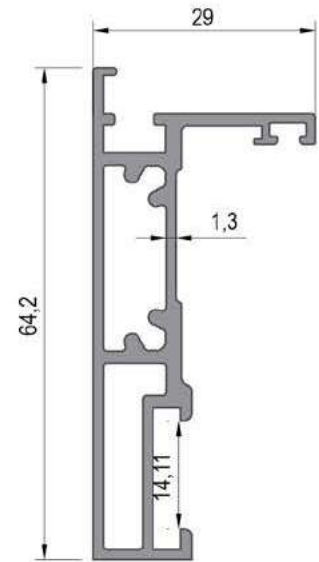

6789

Kod/Code	Et Kalın./Wall Thk.	Ürün Adı / Prod. Name	Ağırlığı / Weight	Köşe Takoğu / C. Cleat
6790	1,6 mm	Kenet Kanat Pr. / Interlock Sash Profile	0,538 kg/mt	-
6789	1,3 mm	Orta Kayıt Pr. / Middle Transom Profile	0,785 kg/mt	-

Tekli Kasa Adap. Pro.- Single Frame Adapter Profile
6783
0,514 kg/mt

Tekli Kasa Adap. Pro. - Single Frame Adap. Pro.
6782
0,446 kg/mt

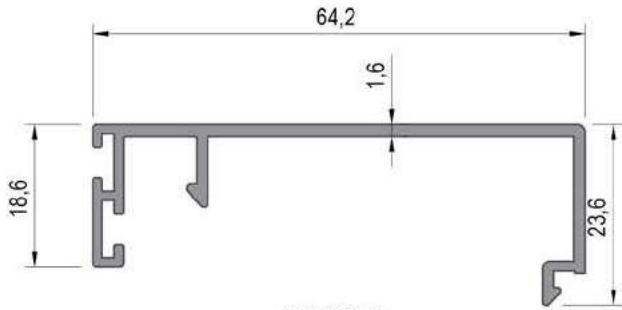

6783

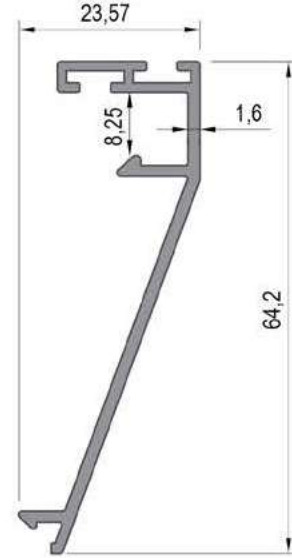

6782

Kod/Code	Et Kalın./Wall Thk.	Ürün Adı / Prod. Name	Ağırlığı / Weight	Köşe Takozu / C. Cleat
6783	1,6 mm	Adaptör Profili / Adapter Profile	0,514 kg/mt	-
6782	1,6 mm	Adaptör Profili / Adapter Profile	0,446 kg/mt	-

Cam Çita Profili - Glazing Bead Profile
6875
0,271 kg/mt

Sineklik Profili - Fly Screen Profile
7020
0,532 kg/mt

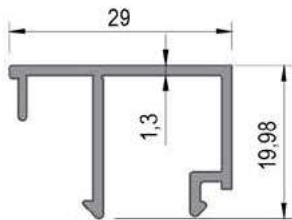

6875

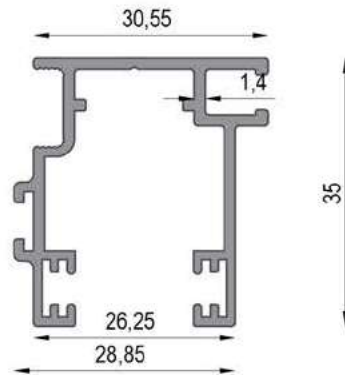

7020

Kod/Code	Et Kalın./Wall Thk.	Ürün Adı / Prod. Name	Ağırlığı / Weight	Köşe Takozu / C. Cleat
6875	1,3 mm	Cam Çita / Glazing Bead Profile	0,271 kg/mt	-
7020	1,4 mm	Sineklik Profili / Fly Screen Profile	0,532 kg/mt	-

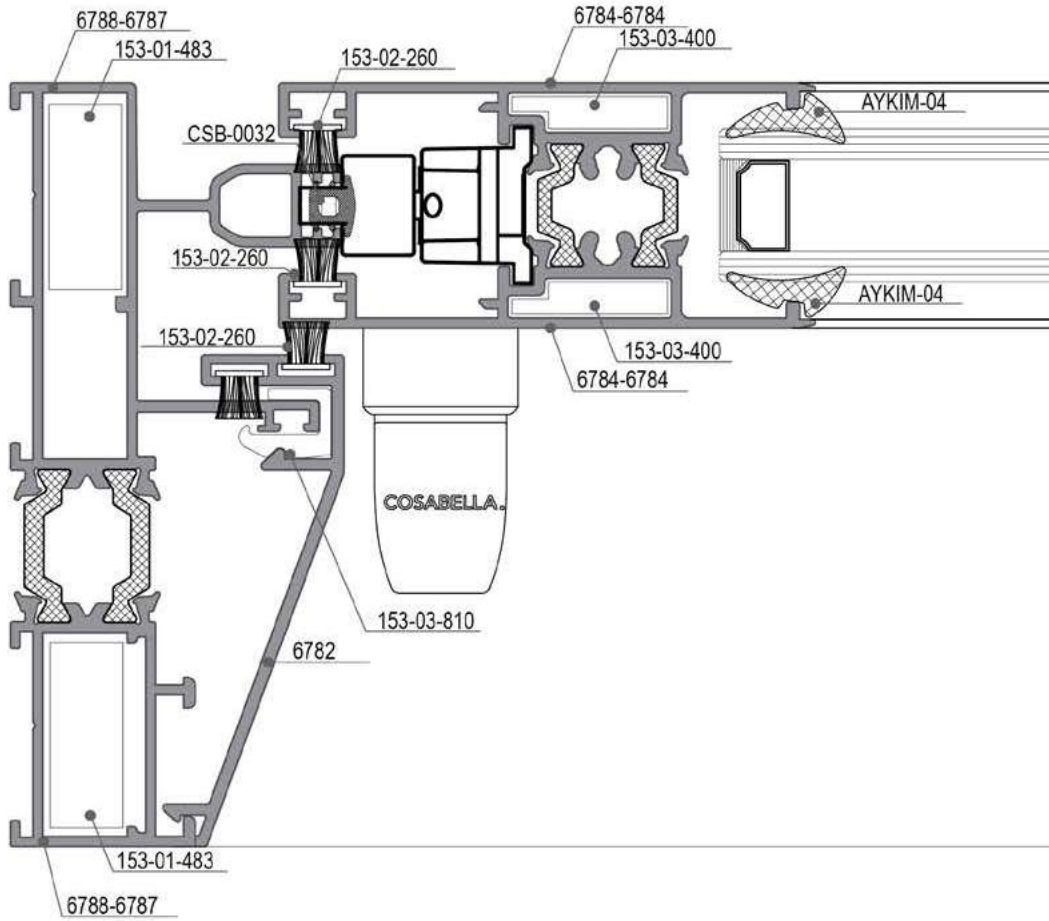
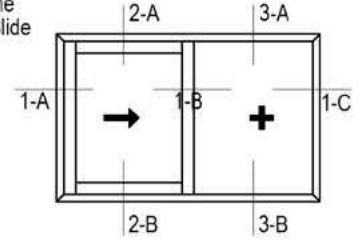
90° Klasik Tek Ray Sürme
 90° Classical Monorail Slide

 1-A
 DETAYI
 DETAIL

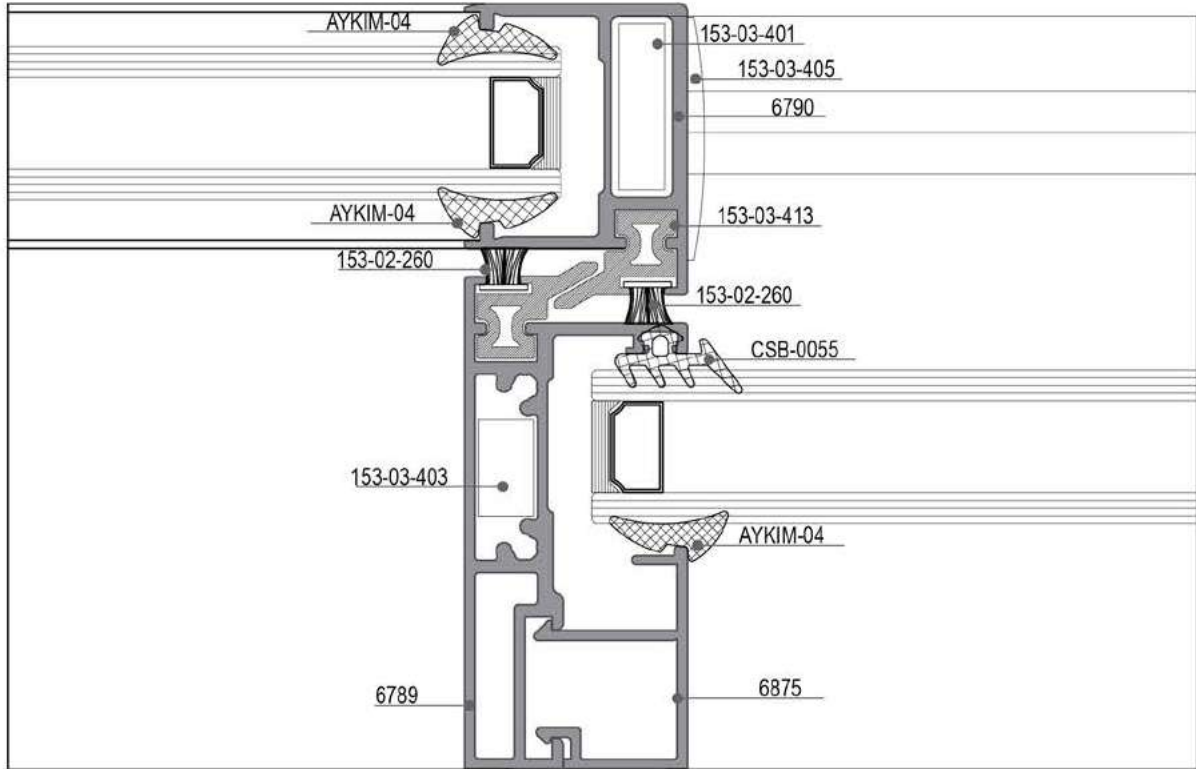
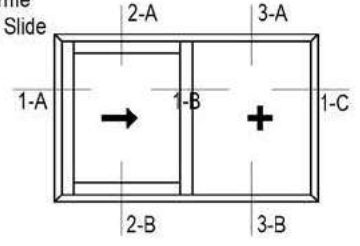
Ölçek: 1:1 / Scale: 1:1

90° Klasik Tek Ray Sürme
90° Classical Monorail Slide1-B
DETAYI
DETAIL

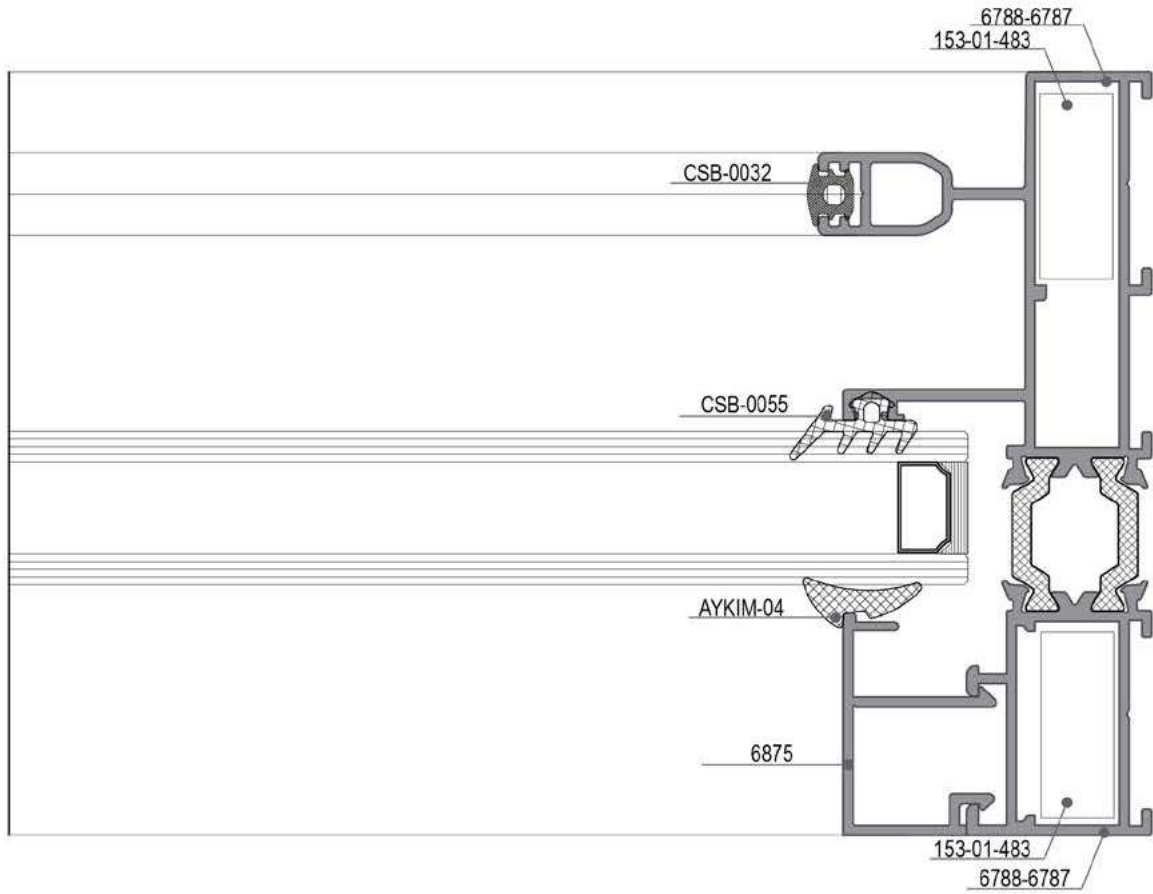
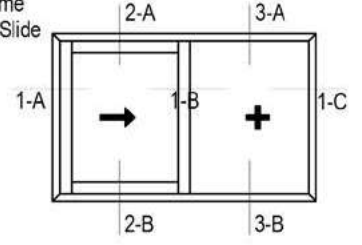
Ölçek: 1:1 / Scale: 1:1

90° Klasik Tek Ray Sürme
 90° Classical Monorail Slide

 1-C
 DETAYI
 DETAIL

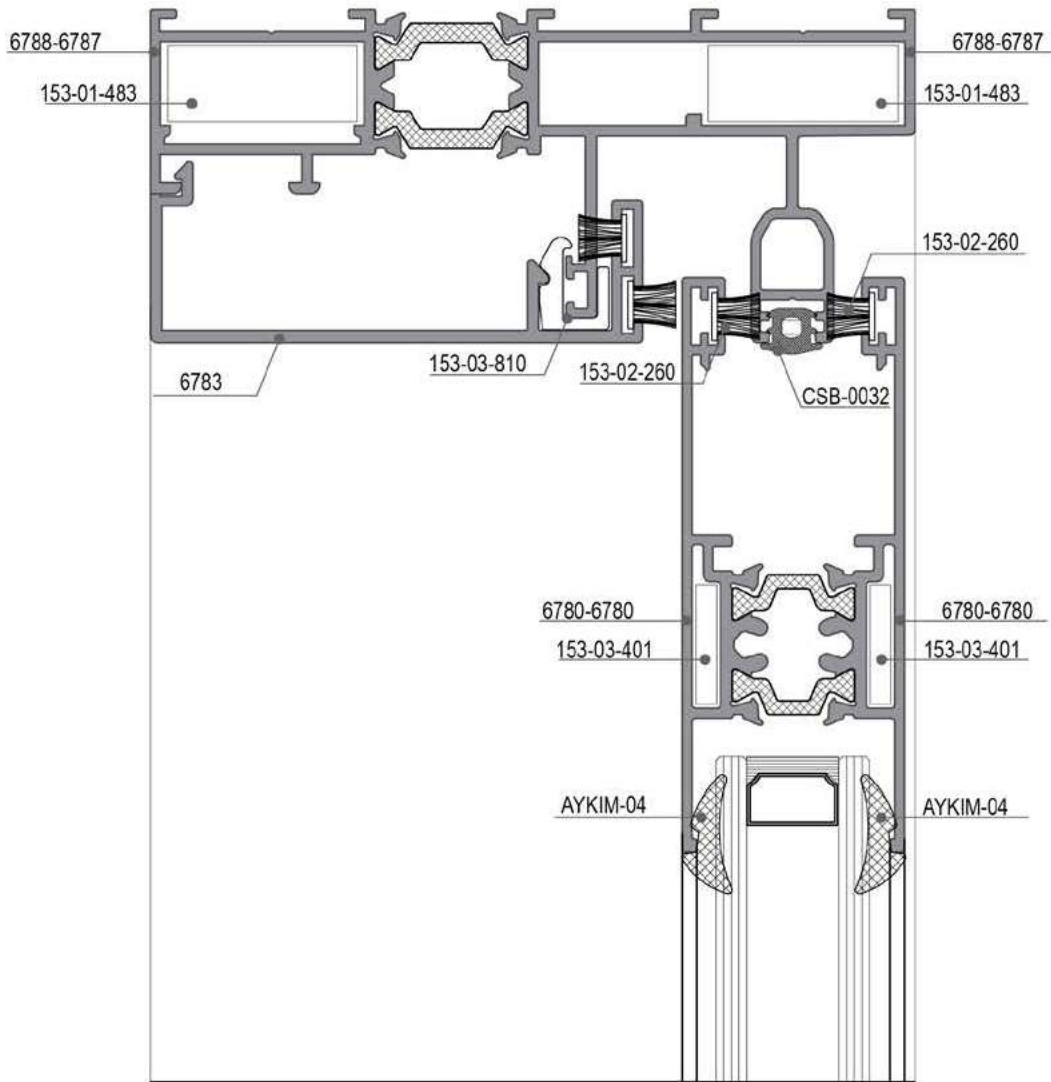
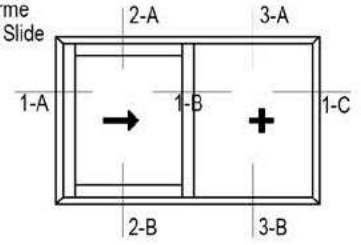
Ölçek: 1:1 / Scale: 1:1

90° Klasik Tek Ray Sürme
90° Classical Monorail Slide2-A
DETAYI
DETAIL

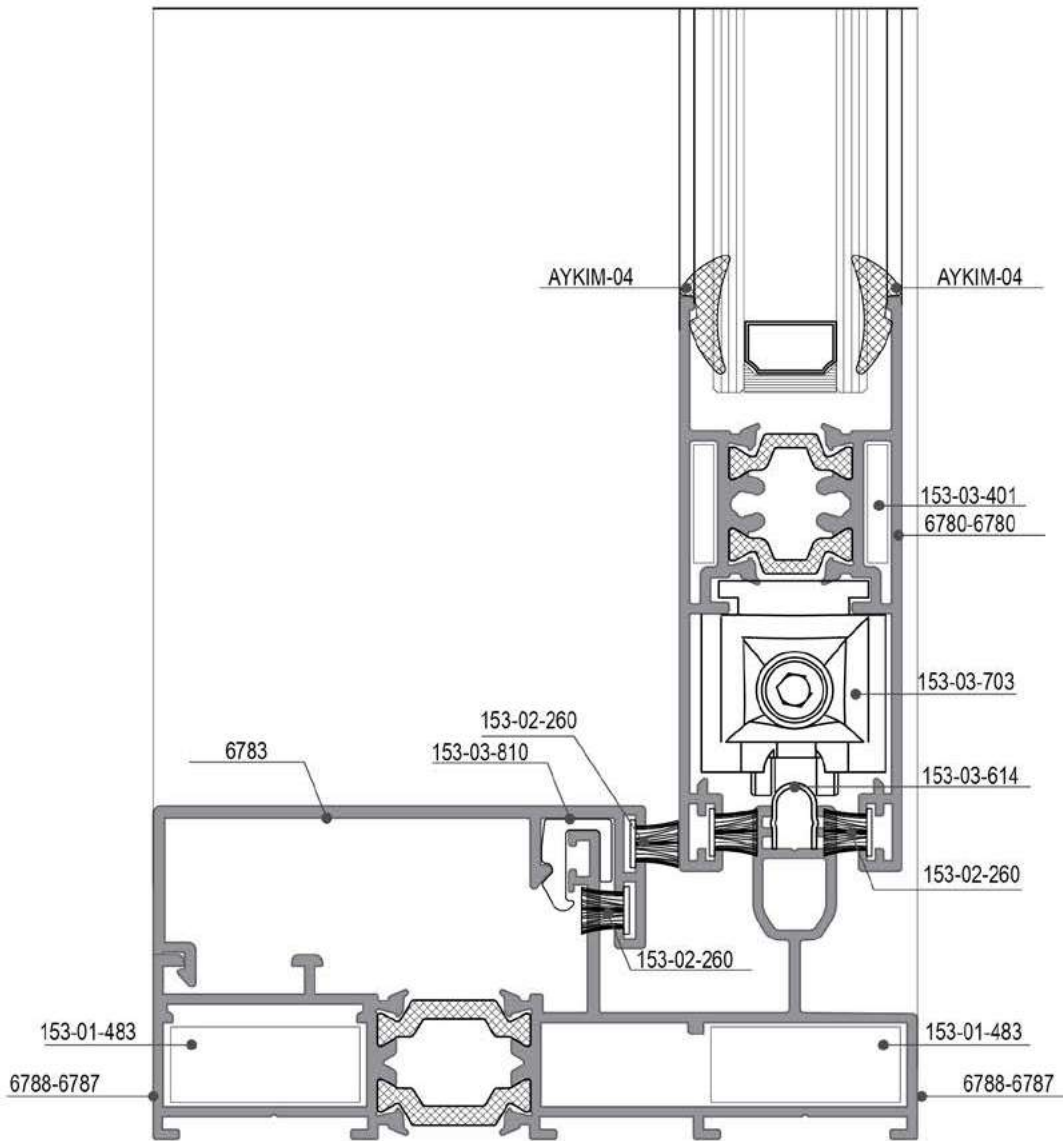
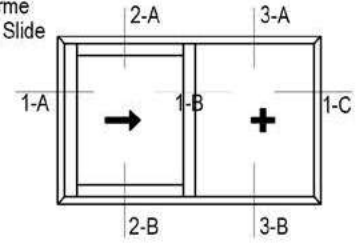
Ölçek: 1:1 / Scale: 1:1

90° Klasik Tek Ray Sürme
 90° Classical Monorail Slide

 2-B
 DETAYI
 DETAIL

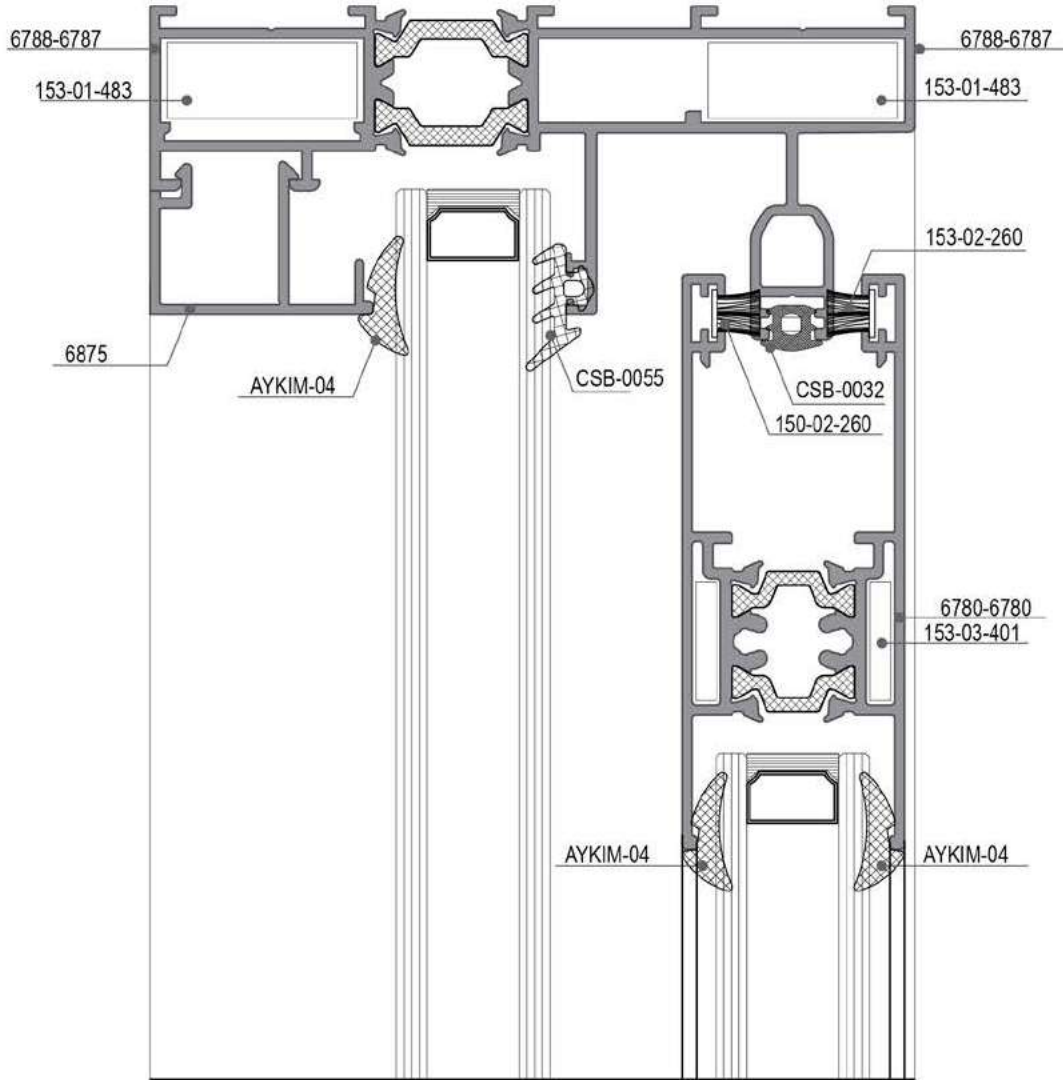
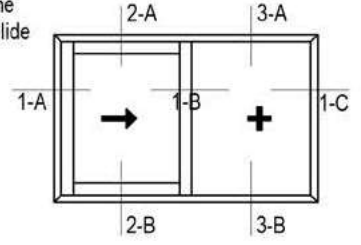
Ölçek: 1:1 / Scale: 1:1

90° Klasik Tek Ray Sürme
90° Classical Monorail Slide3-A
DETAYI
DETAIL

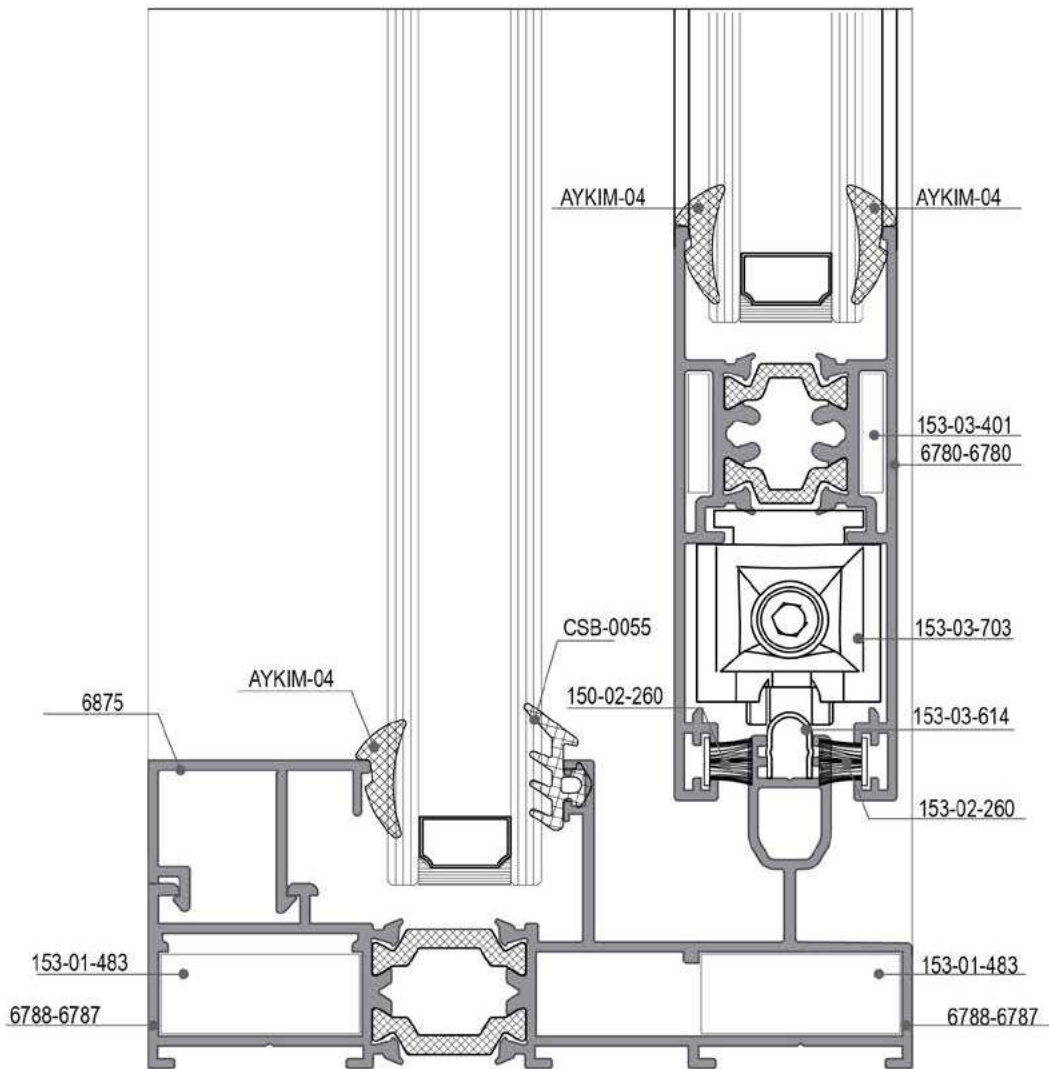
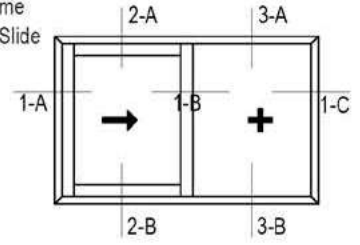
Ölçek: 1:1 / Scale: 1:1

90° Klasik Tek Ray Sürme
 90° Classical Monorail Slide

 3-B DETAYI
 DETAIL

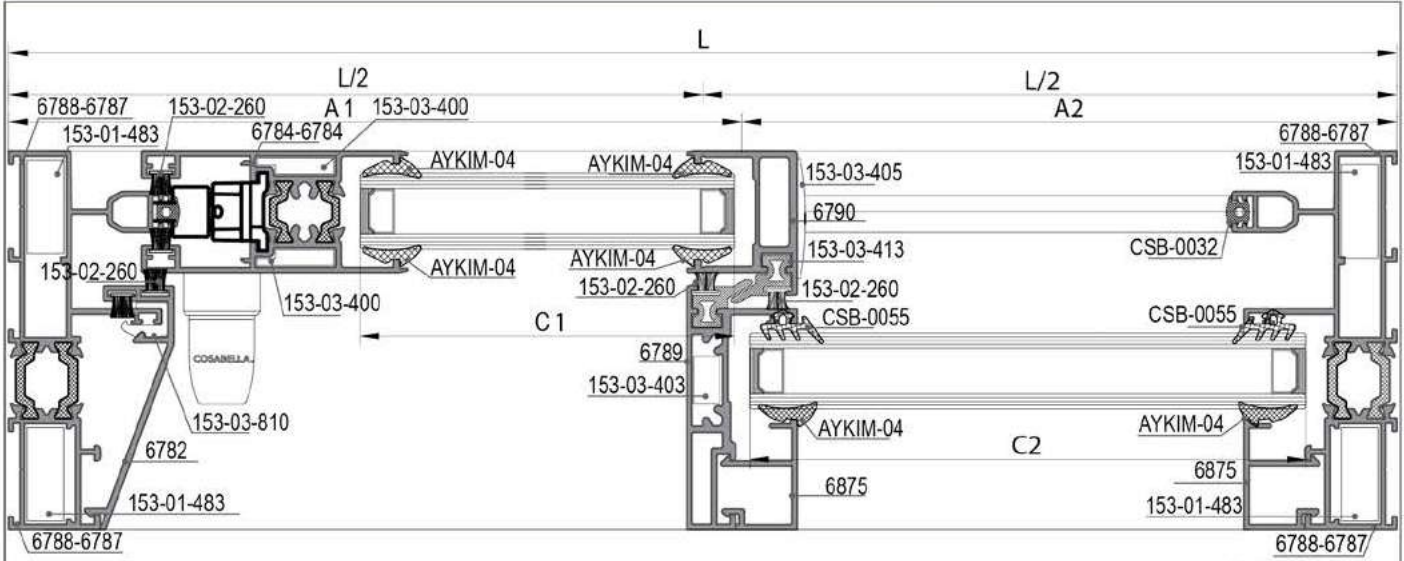
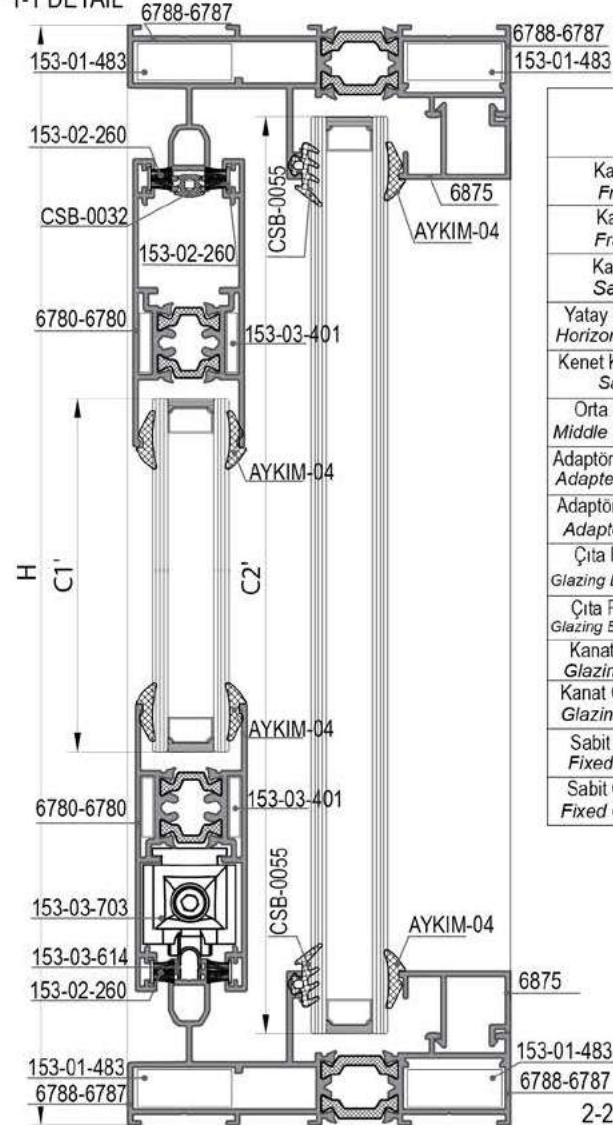
Ölçek: 1:1 / Scale: 1:1

1-1 DETAYI
1-1 DETAIL1-1 DETAYI
1-1 DETAIL

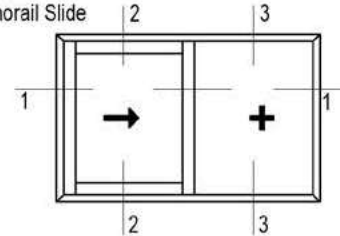
Kasa Genişlik Frame Width	6788-6787			2 Ad. 2 Pcs.	L
Kasa Yükseklik Frame Height	6788-6787			2 Ad. 2 Pcs.	H
Kanat Yükseklik Sash Height	6784-6784			1 Ad. 1 Pcs.	K=H-76
Yatay Kanat Genişlik Horizontal Sash Width	6780-6780			2 Ad. 2 Pcs.	A1-115,46
Kenet Kanat Yükseklik Sash Height	6790			1 Ad. 1 Pcs.	H-76
Orta Kayıt Yükseklik Middle Transon Height	6789			1 Ad. 1 Pcs.	H-80,46
Adaptör Profili Yükseklik Adapter Profile Height	6782			1 Ad. 1 Pcs.	H-87
Adaptör Profili Genişlik Adapter Profile Width	6783			2 Ad. 2 Pcs.	A1-38,6
Çıta Profil Genişlik Glazing Bead Profile Width	6785			2 Ad. 2 Pcs.	A2-22,47
Çıta Profil Yükseklik Glazing Bead Profile Height	6785			2 Ad. 2 Pcs.	H-80,46
Kanat Cam Genişlik Glazing Sash Width				1 Ad. 1 Pcs.	C1=A1-94,51
Kanat Cam Yükseklik Glazing Sash Height				1 Ad. 1 Pcs.	C1'=H-195
Sabit Cam Genişlik Fixed Glazing Width				1 Ad. 1 Pcs.	C2=A2-25,45
Sabit Cam Yükseklik Fixed Glazing Height				1 Ad. 1 Pcs.	C2'=H-47,8

90° Klasik Tek Ray Sürme
90° Classical Monorail Slide

Kesim ölçüsü - cam ölçüsü vb. sorumluluğu tarafımıza ait değildir.

Çizimler 1/2 Ölçeklidir.

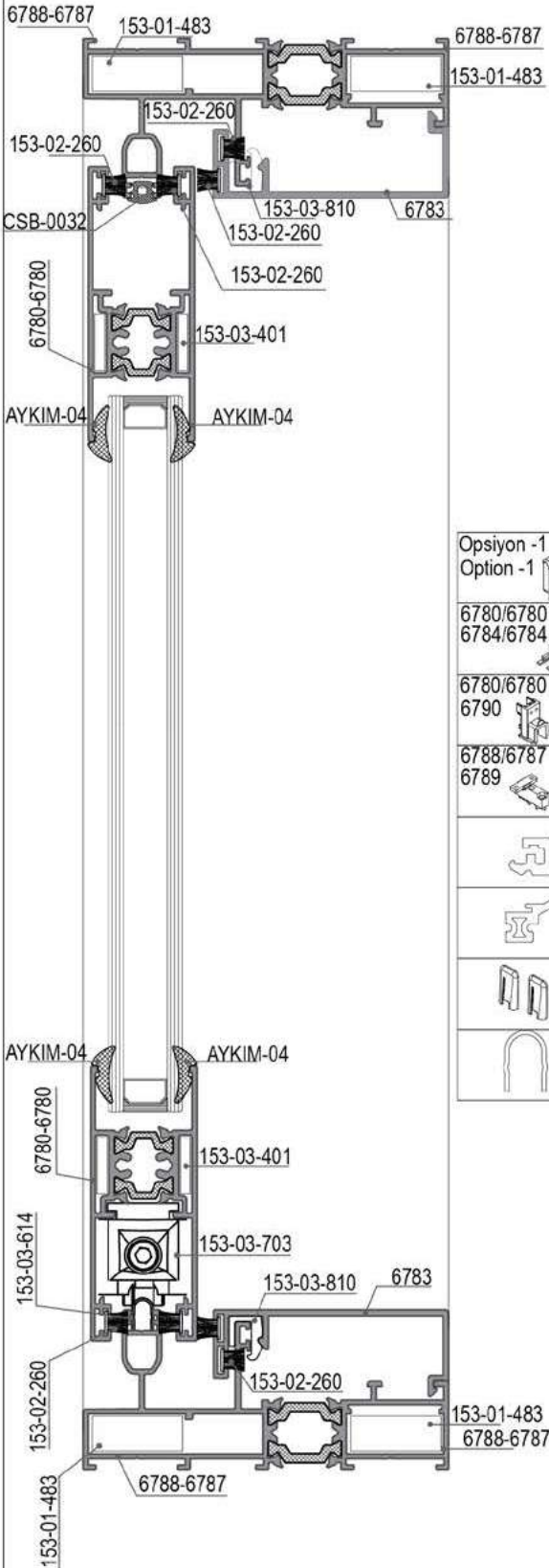

Opsiyon -1 Option -1	153-01-483 Vidalı Köşe Bağ. Takozu Screwed Corner Cleat	8 Ad. 8 Pcs.		153-03-703 Ayarlı Rulman Adjustable Roller	2 Ad. 2 Pcs.
6780/6780 6784/6784	153-03-400 90° Geniş Köşe Bağlantı 90° Wide Sash Cor.Joint	2 Ad. 2 Pcs.		153-03-404 Kasa Alt & Üst Tozluks Central Top & Bottom Sealing	1 Tkm. 1 Set
6780/6780 6790	153-03-401 90° Dar Köşe Bağlantı 90° Narrow Sash Cor.Joint	2 Ad. 2 Pcs.		153-03-408 Stoplama	2 Ad. 2 Pcs.
6788/6787 6789	153-03-403 90° Dar Köşe Bağlantı 90° Narrow Sash Cor.Joint	2 Ad. 2 Pcs.		153-02-260 Fırça Fitol Brush Pile Seal	6H+4L
	153-03-810 Adaptör Kenetleme Klipsi Plastic Lock Clips	30cm ara ile kullanılacak.		CSB-0032 Ray Kapama Contası Gasket For Frame Rails	1L+2H
	153-03-413 Kanat Kenetleme Plastik Plastic Sash Lock Adapter	Metre Meter H-76		AYKIM-04 Glazing Wedge Gasket (Cam Tercihine Göre) (Optional Glass Size)	4C1+4C1+ 2C2+2C'
	153-03-405 Adaptör Kapağı Alt & Üst Adapter Cap Bottom & Top	2 Adet 2 Pcs.		CSB-0055 Dış Cam Contası External Glass Gasket	2C2'+2C2
	153-03-614 Paslanmaz Çelik Ray Stainless Steel Rail Track	L-76 mm. 1 Ad./Pcs.			

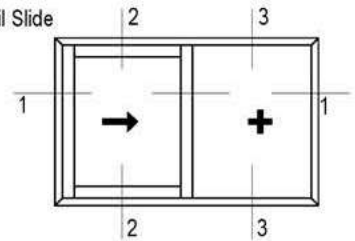
 90° Klasik Tek Ray Sürme
 90° Classical Monorail Slide

 3-3 DETAYI
 3-3 DETAIL

Kesim ölçüsü - cam ölçüsü vb. sorumluluğu tarafımıza ait değildir.

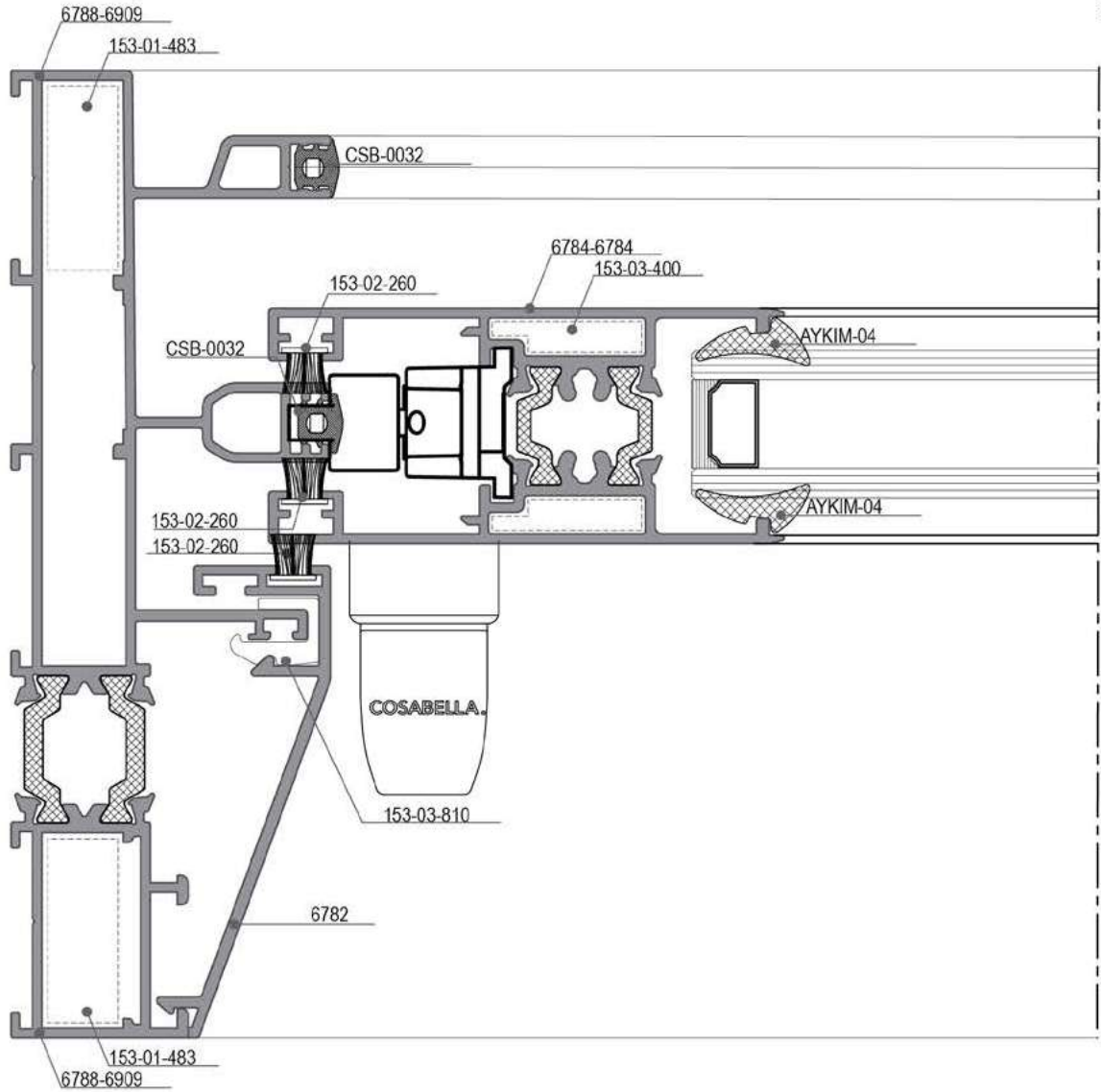
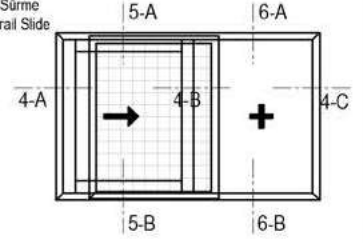
Çizimler Ölçeksizdir.

90° Klasik Tek Ray Sürme
90° Classical Monorail Slide4-A DETAYI
DETAIL

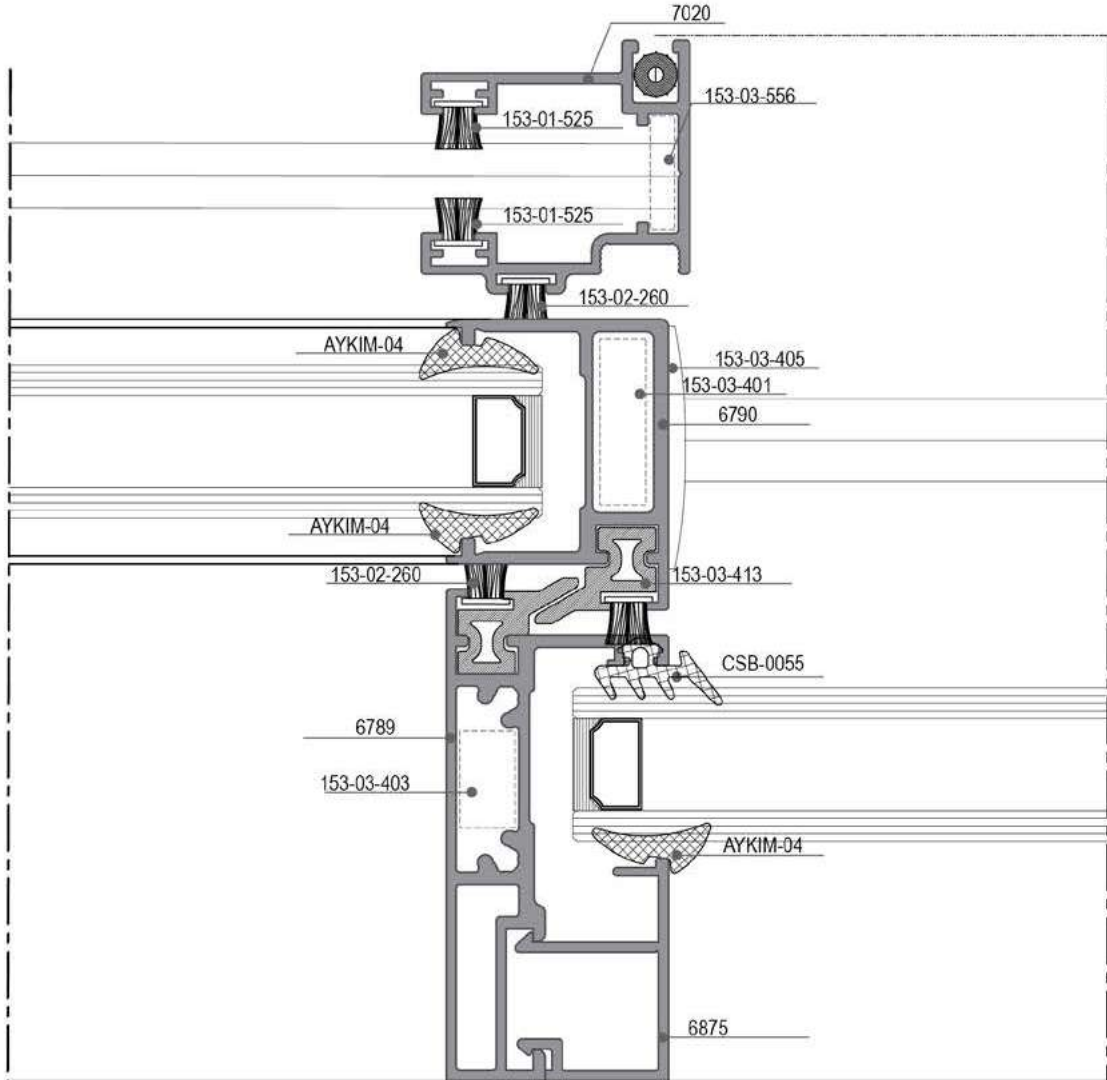
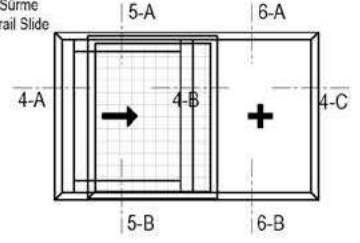
Ölçek: 1:1 / Scale: 1:1

90° Klasik Tek Ray Sürme
 90° Classical Monorail Slide

 4-B DETAYI
 DETAIL

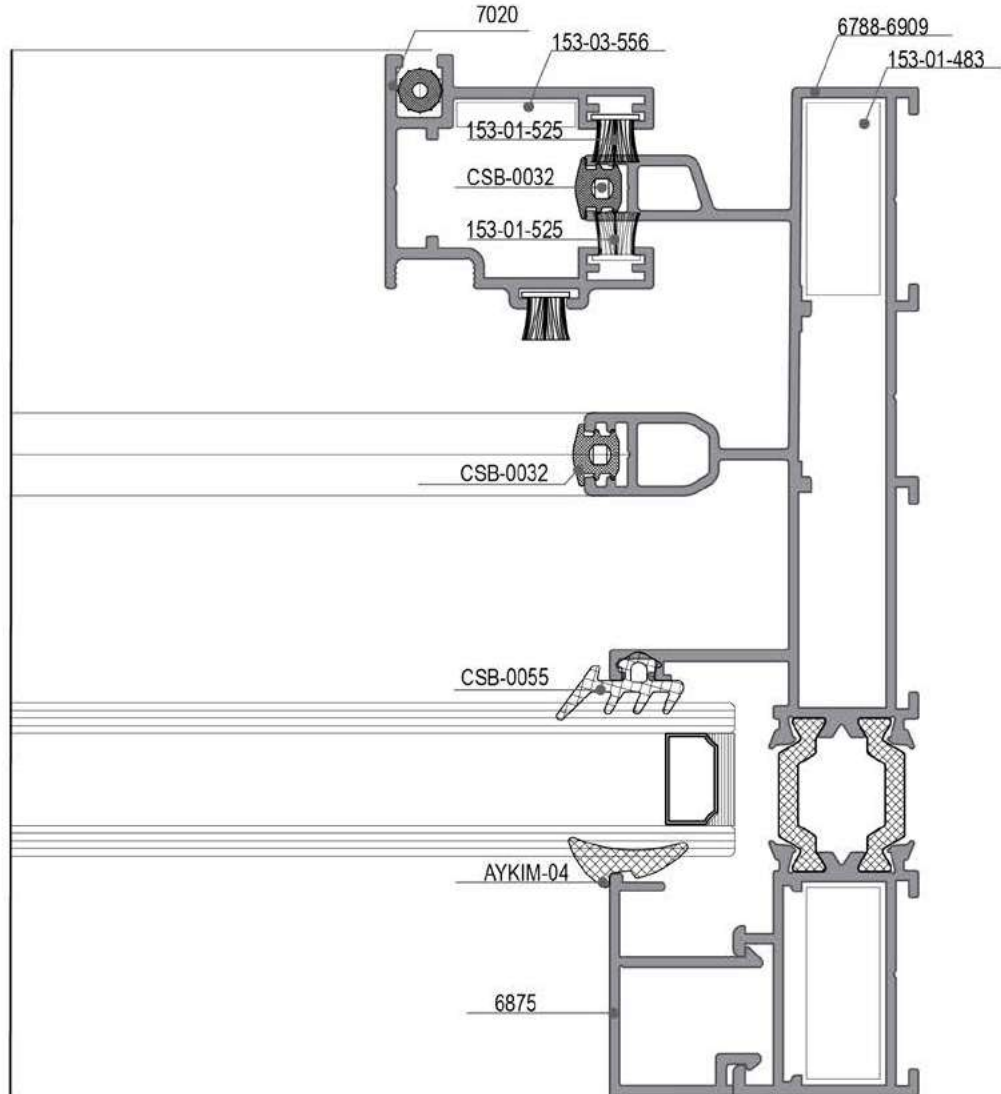
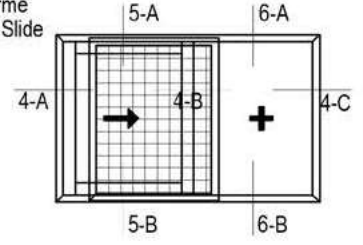
Ölçek: 1:1 / Scale: 1:1

90° Klasik Tek Ray Sürme
90° Classical Monorail Slide4-C DETAYI
DETAIL

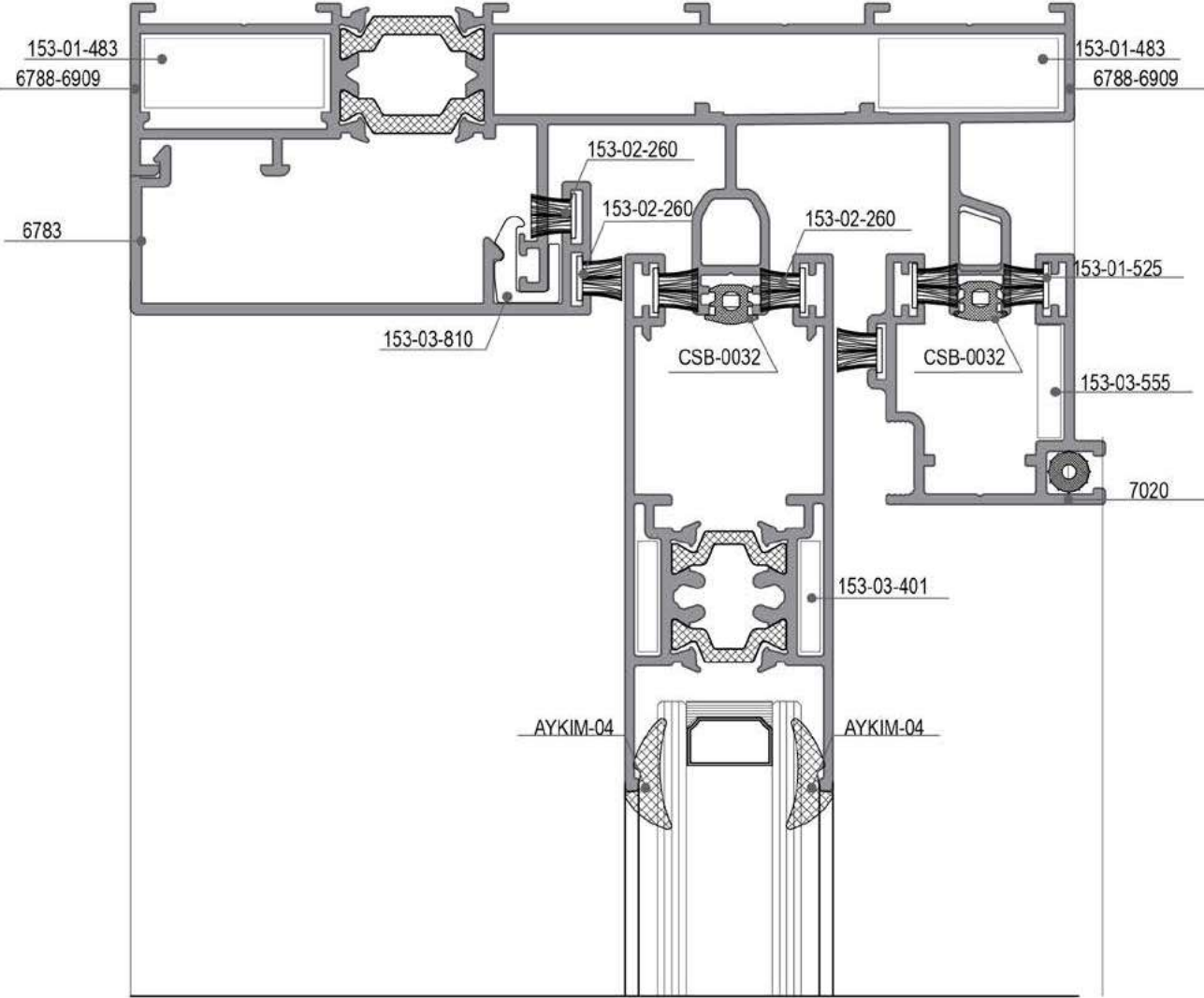
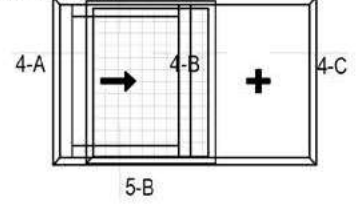
Ölçek: 1:1 / Scale: 1:1

90° Klasik Tek Ray Sürme
 90° Classical Monorail Slide

 5-A
 DETAYI
 DETAIL

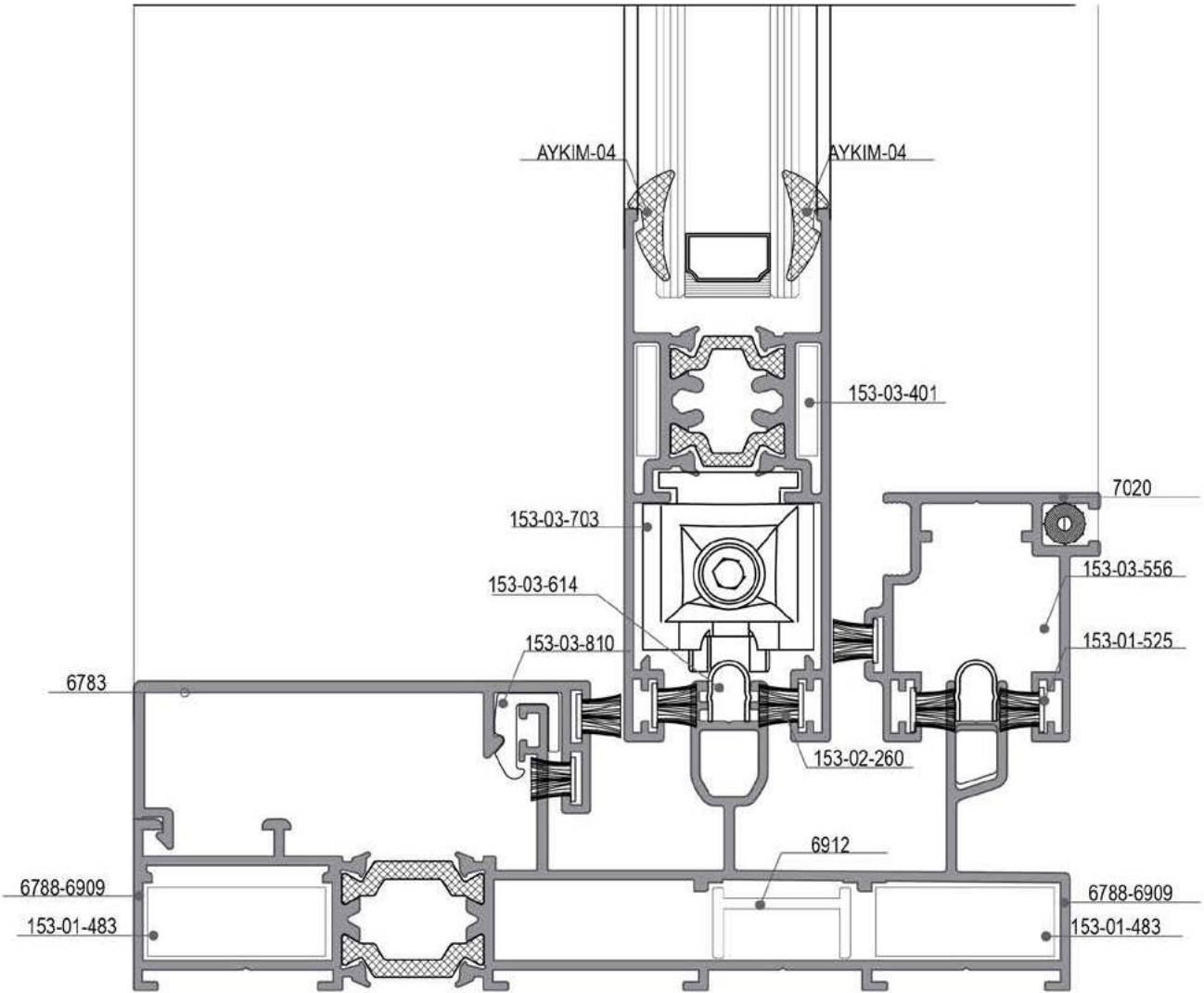
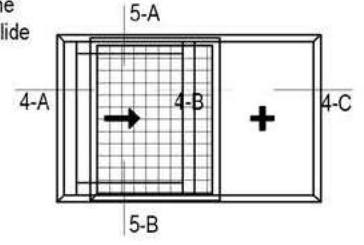
Ölçek: 1:1 / Scale: 1:1

90° Klasik Tek Ray Sürme
90° Classical Monorail Slide5-B
DETAYI
DETAIL

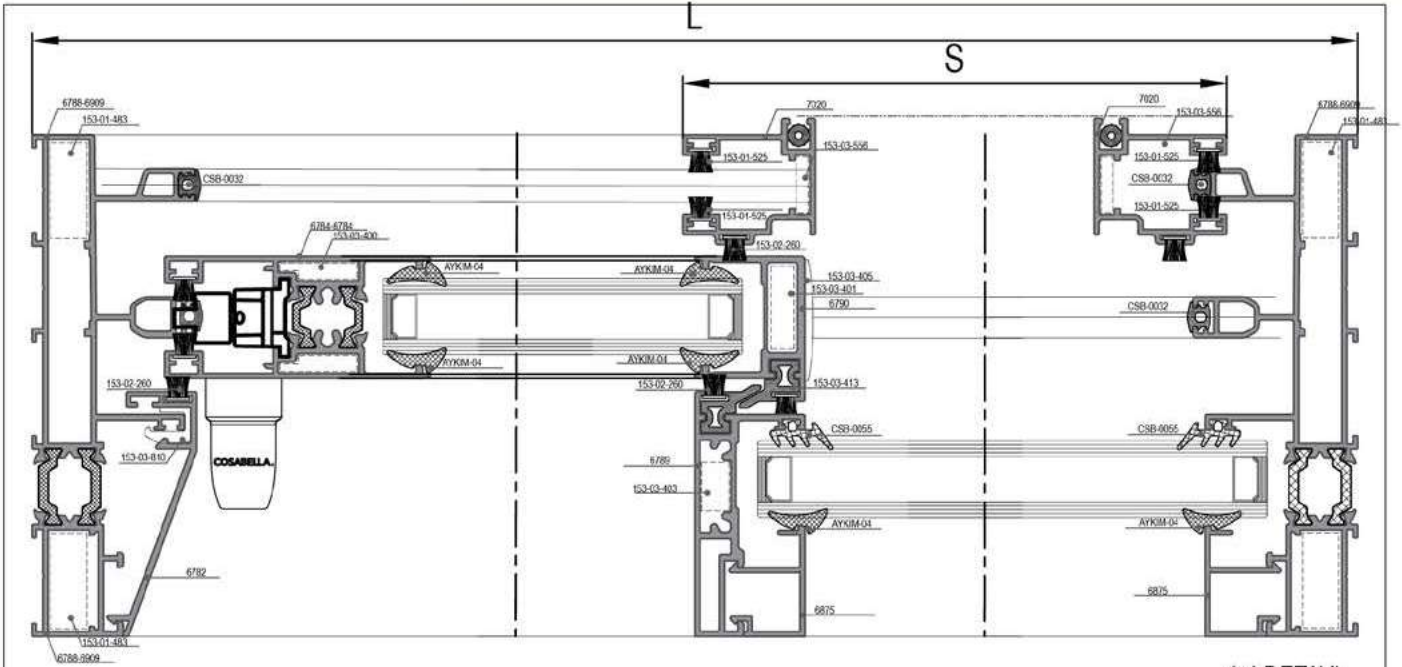
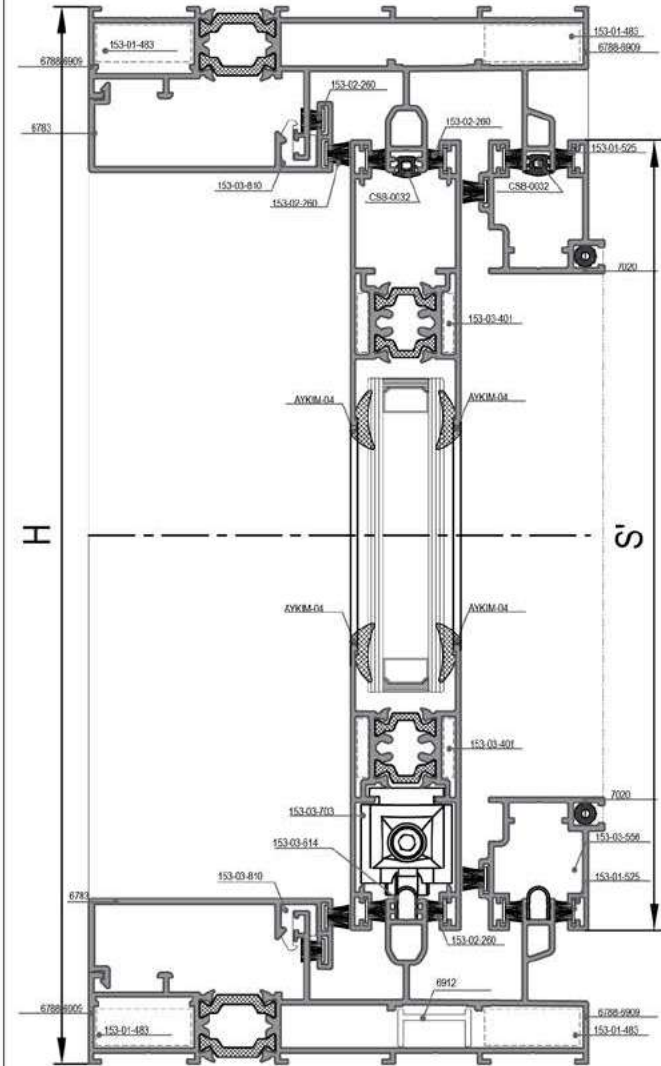
Ölçek: 1:1 / Scale: 1:1

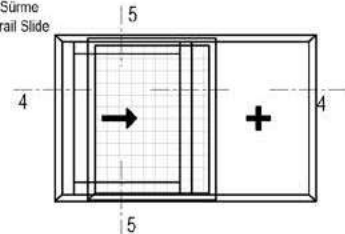

 4-4 DETAYI
 4-4 DETAIL

 5-5 DETAYI
 5-5 DETAIL

	Sineklik Kanat Yükseklik Fly Screen Sash Height	7020		Sineklik Kanat Genişlik Fly Screen Sash Width	7020		153-01-525 Fırça Filtre Brush Pile Seal	4H+2L
							153-02-260 Fırça Filtre Brush Pile Seal	4H+L
	153-03-566 45° Kösge Bağlantı 45° Cor-Joint	2 Ad. 2 Pcs.		153-01-525 Fırça Filtre Brush Pile Seal	4H+2L		153-01-886 Sineklik Filtresi Flyscreen Gasket	S=55mm 2 Ad./ Pcs. S=55mm 2 Ad./ Pcs.
	153-03-566 45° Makaralı Köşe Bağlantı 45° Cor-Joint	2 Ad. 2 Pcs.		153-02-260 Fırça Filtre Brush Pile Seal	4H+L			
	153-03-722 Sineklik Kanat Sloper Sash Flyscreen Sloper	2 Ad. 2 Pcs.		153-01-886 Sineklik Filtresi Flyscreen Gasket	S=55mm 2 Ad./ Pcs. S=55mm 2 Ad./ Pcs.			

 90° Klasik Tek Ray Sürme
 90° Classical Monorail Slide

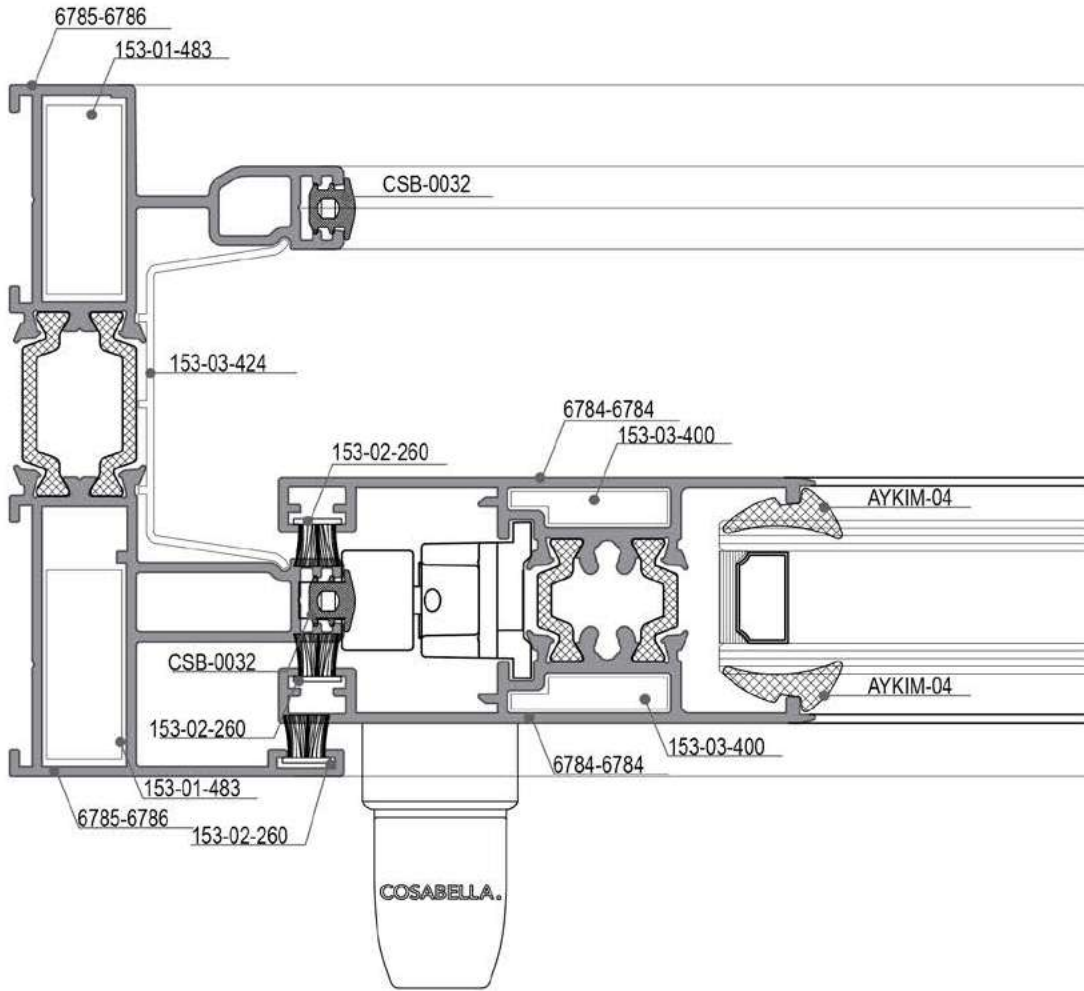
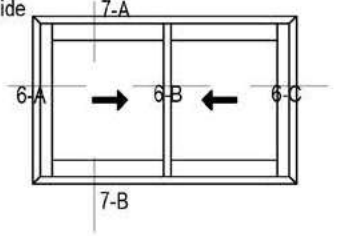
Kesim ölçüsü - cam ölçüsü vb. sorumluluğu tarafımıza ait değildir.

Çizimler 1/2 Ölçeklidir.

90° Klasik Sürme
 90° Classical Slide

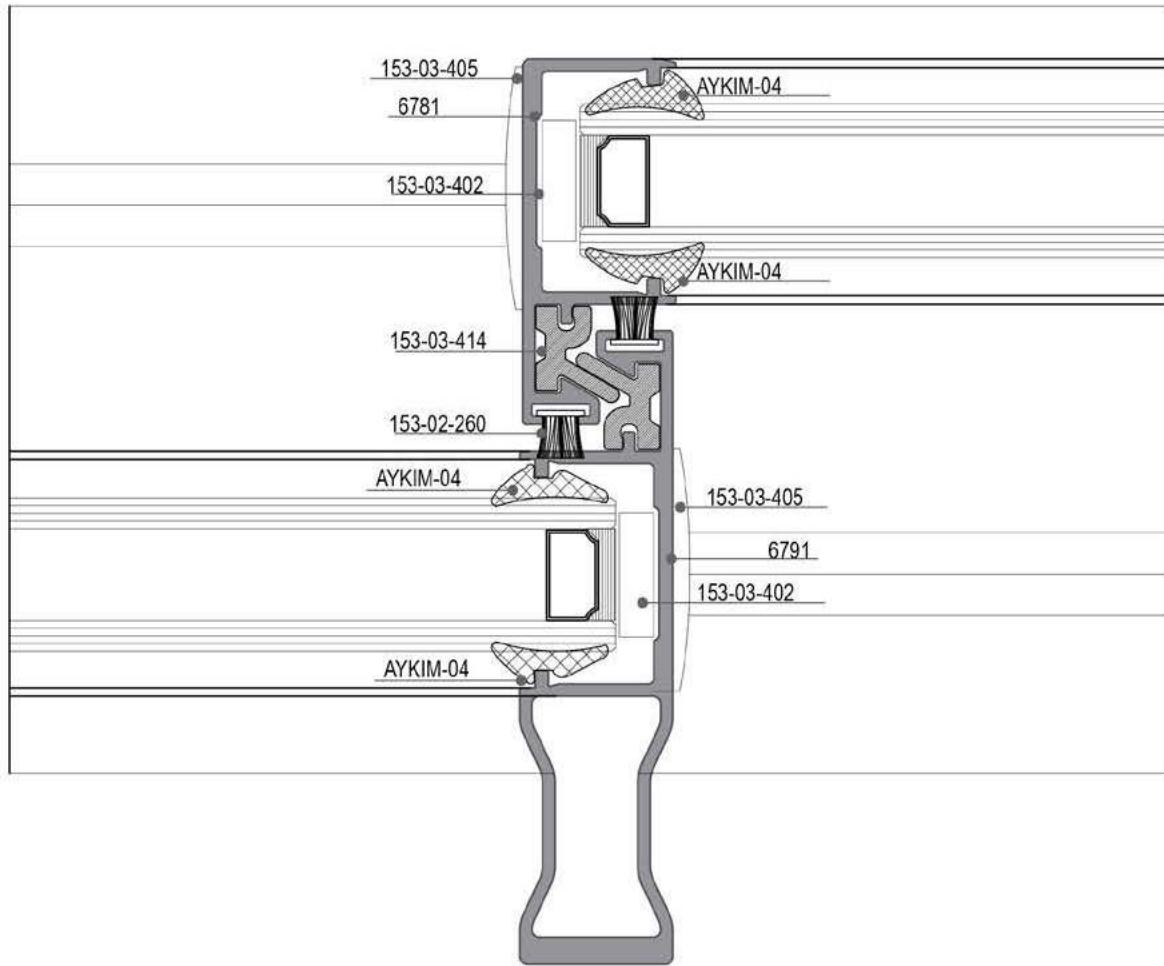
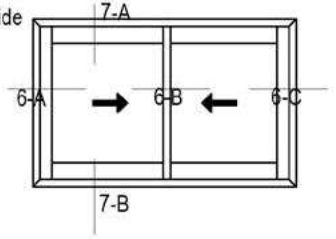
 6-A DETAYI
 DETAIL

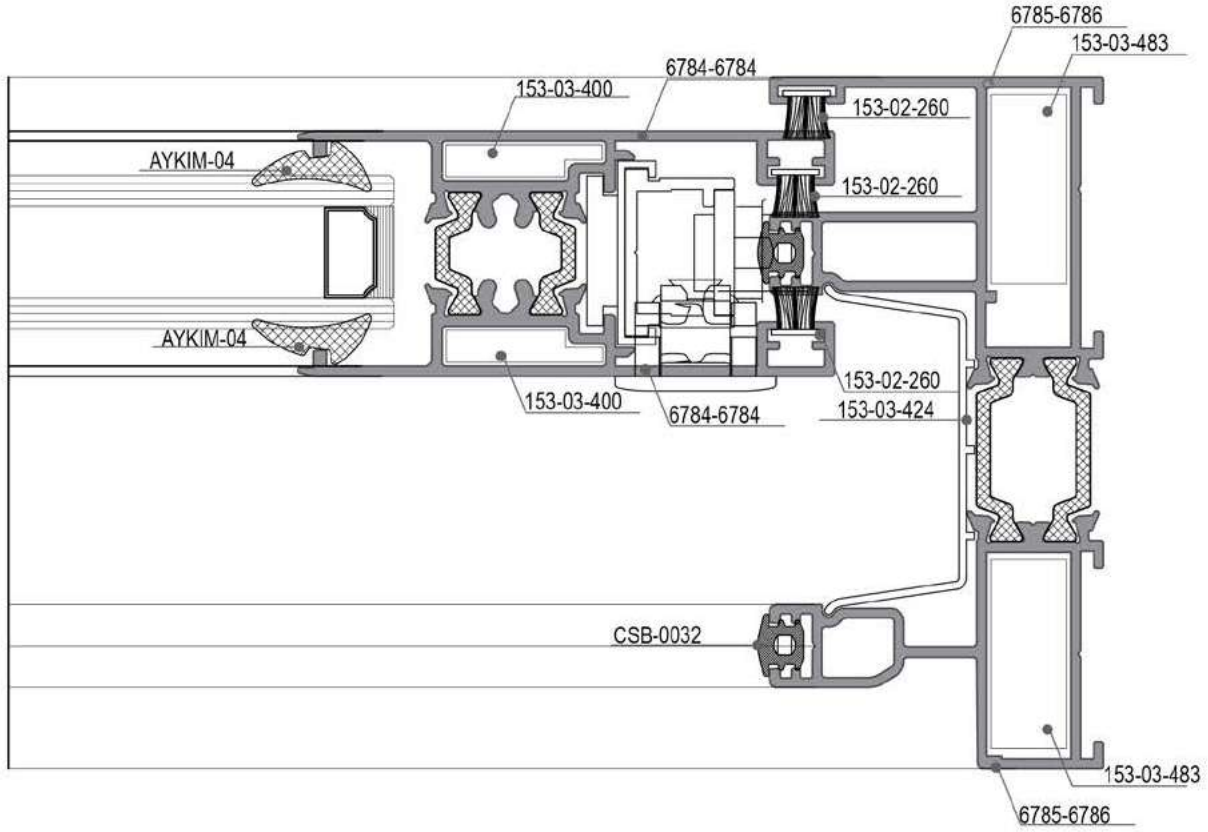
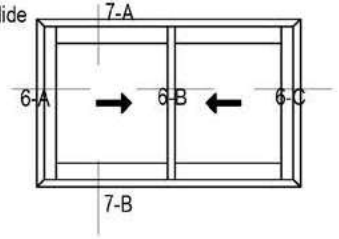
90° Klasik Sürme
 90° Classical Slide

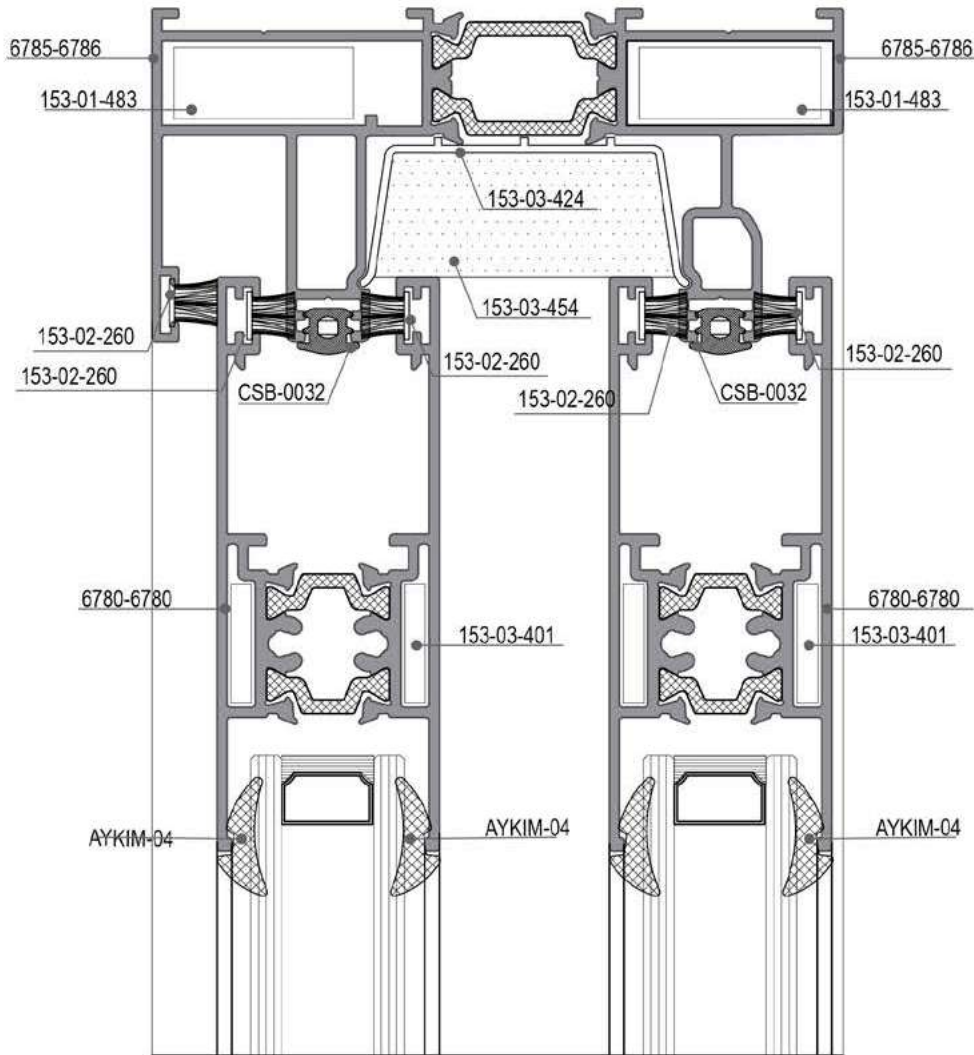
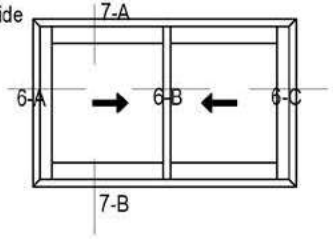
 6-B DETAYI
 DETAIL

90° Klasik Sürme
90° Classical Slide6-C
DETAYI
DETAIL

90° Klasik Sürme
 90° Classical Slide

7-A

 DETAYI
 DETAIL

Ölçek: 1:1 / Scale: 1:1

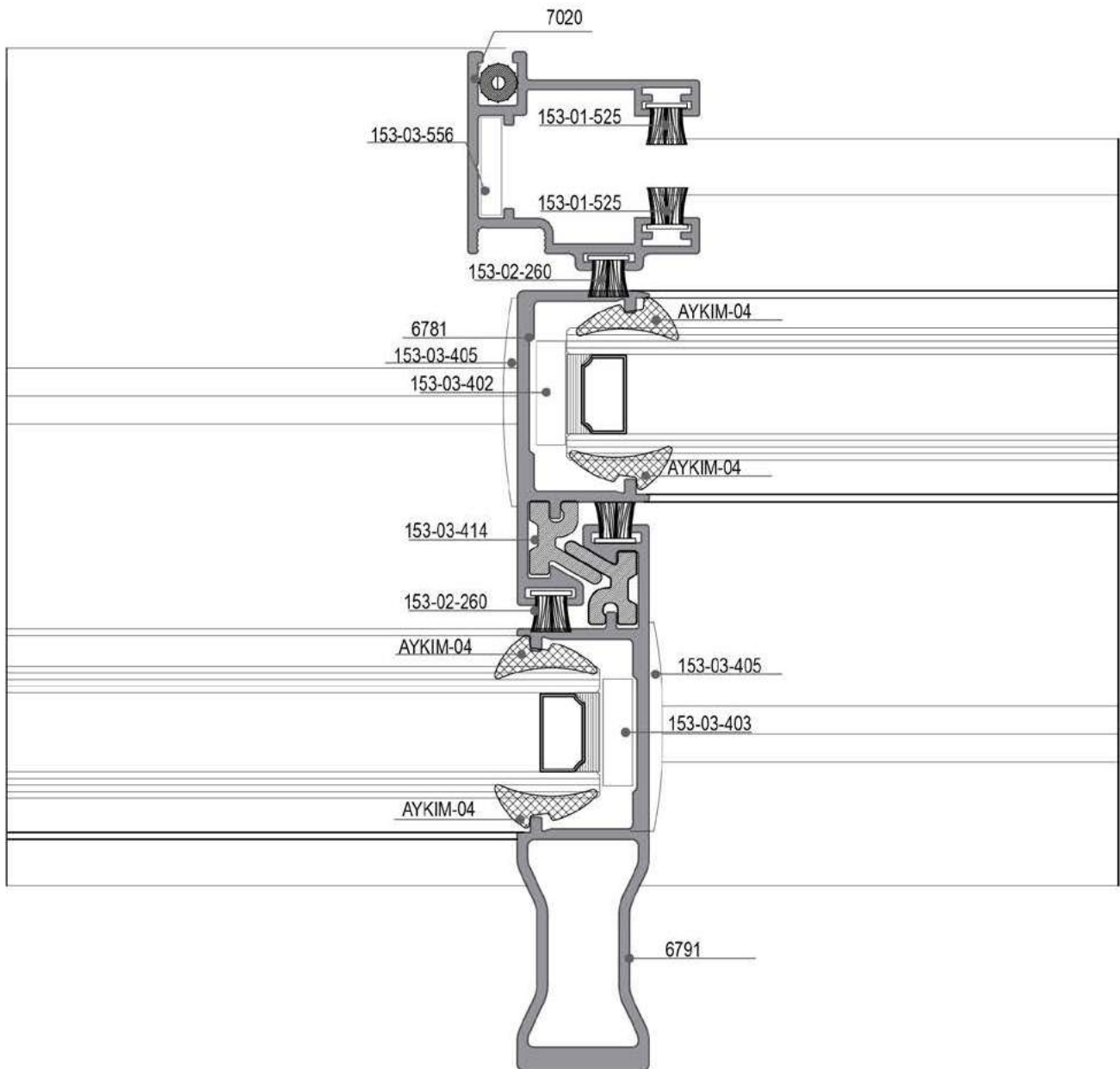
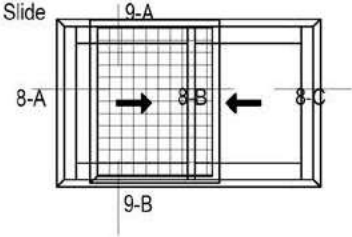
90° Klasik Sürme
90° Classical Slide8-B DETAYI
DETAIL

Ölçek: 1:1 / Scale: 1:1

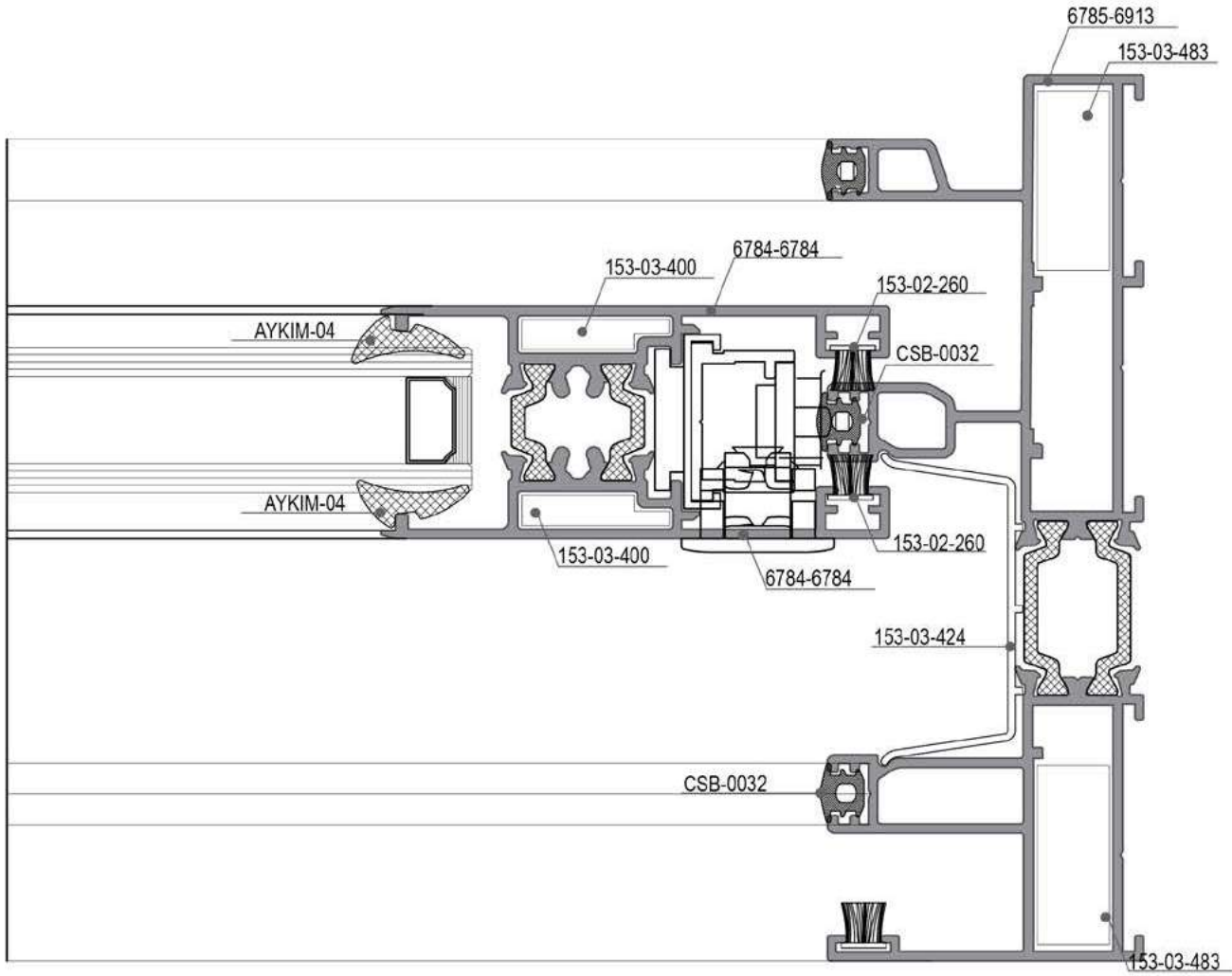
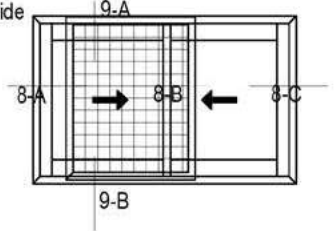
90° Klasik Sürme
 90° Classical Slide

 8-C
 DETAYI
 DETAIL

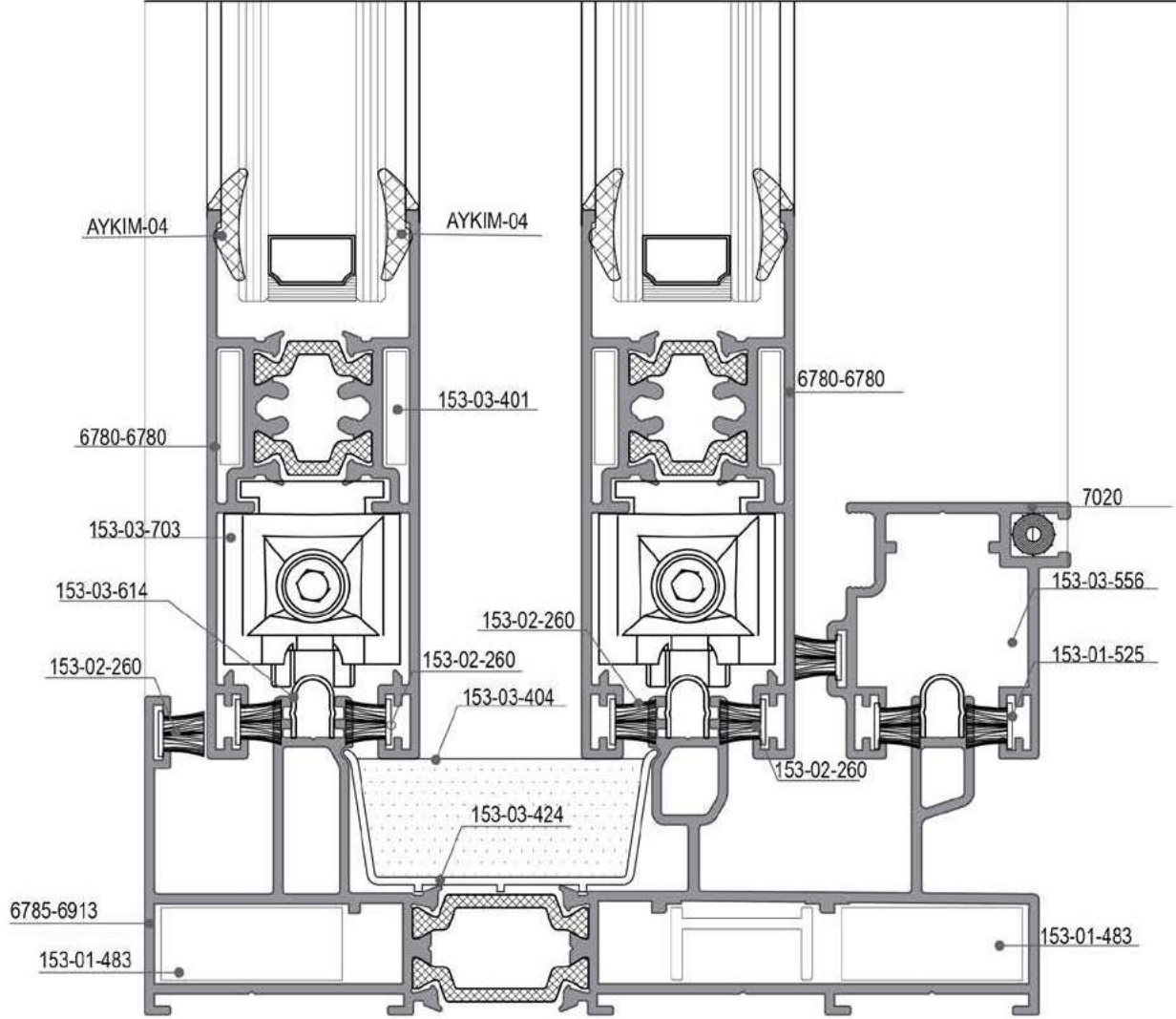
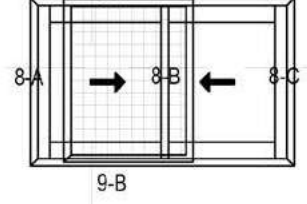
Ölçek: 1:1 / Scale: 1:1

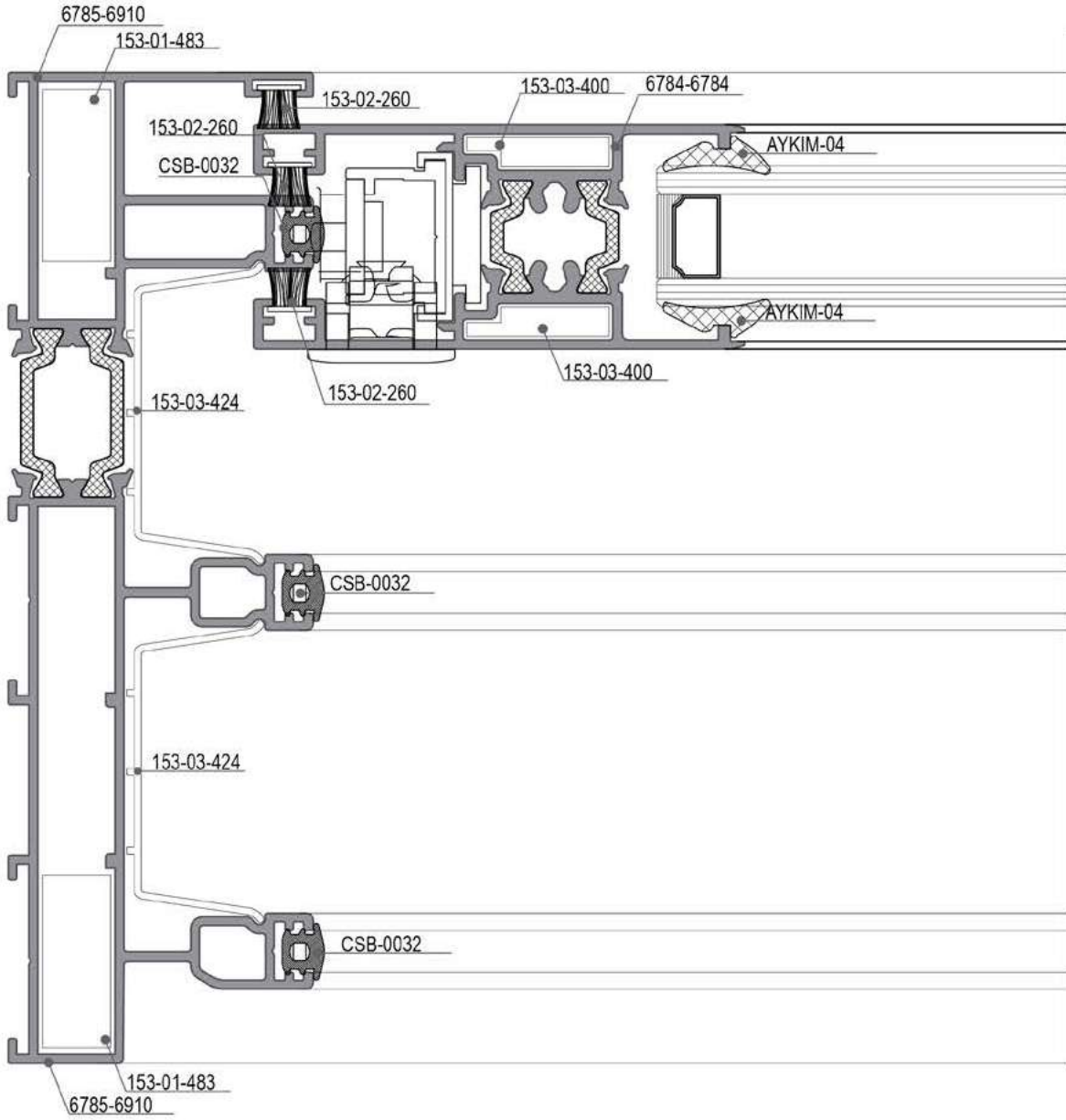
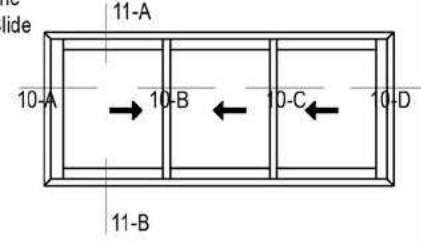
90° Klasik Sürme
90° Classical Slide9-B
DETAYI
DETAILÖlçek: 1:1
Scale: 1:1

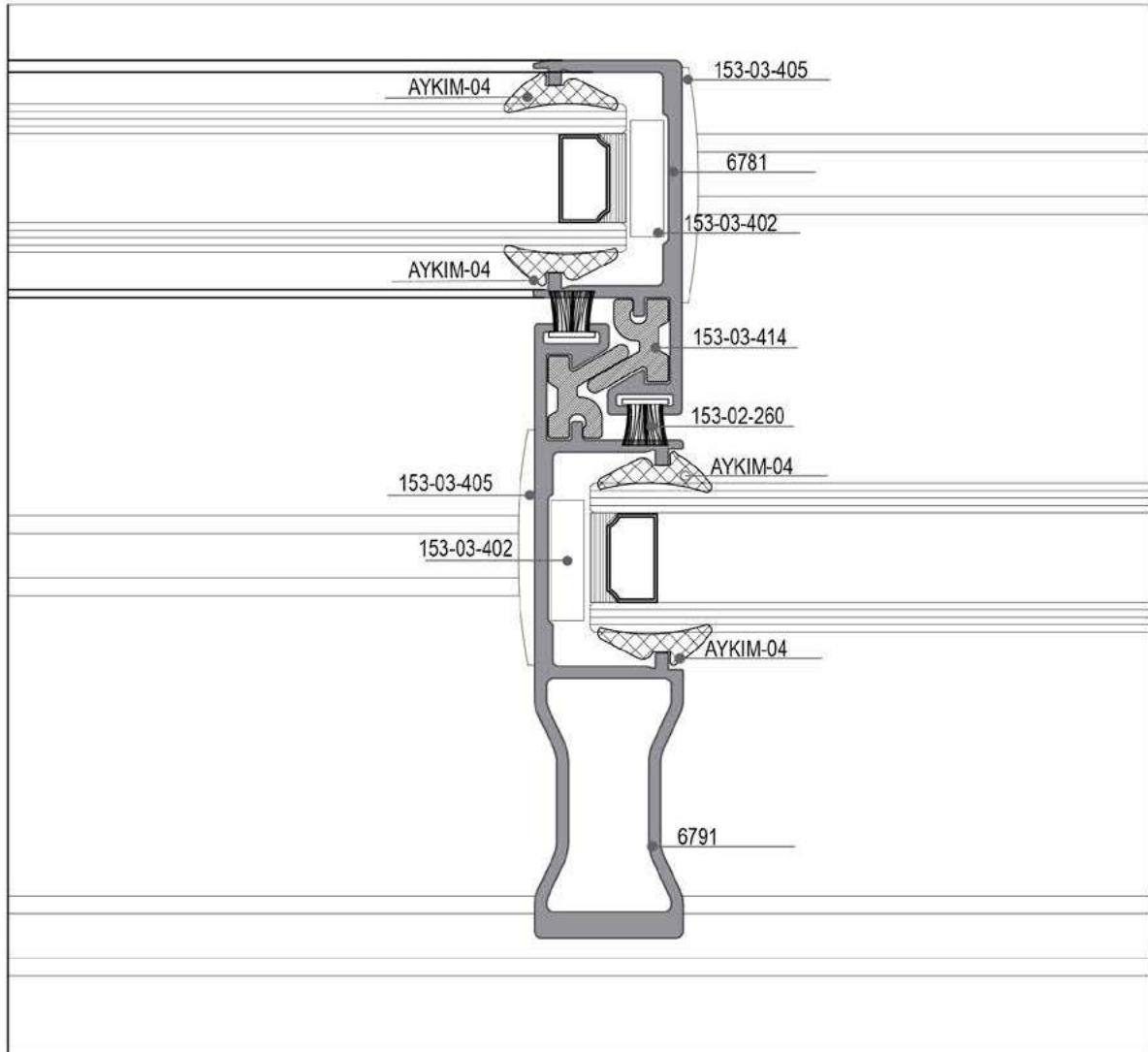
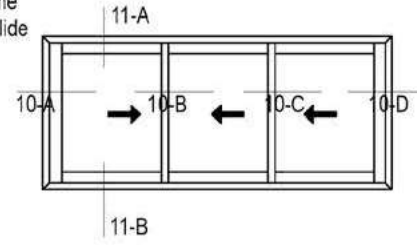
90° Klasik Sürme
90° Classical Slide10-A
DETAYI
DETAILÖlçek: 1:1
Scale: 1:1

90° Klasik Sürme
 90° Classical Slide

 10-B DETAYI
 DETAIL

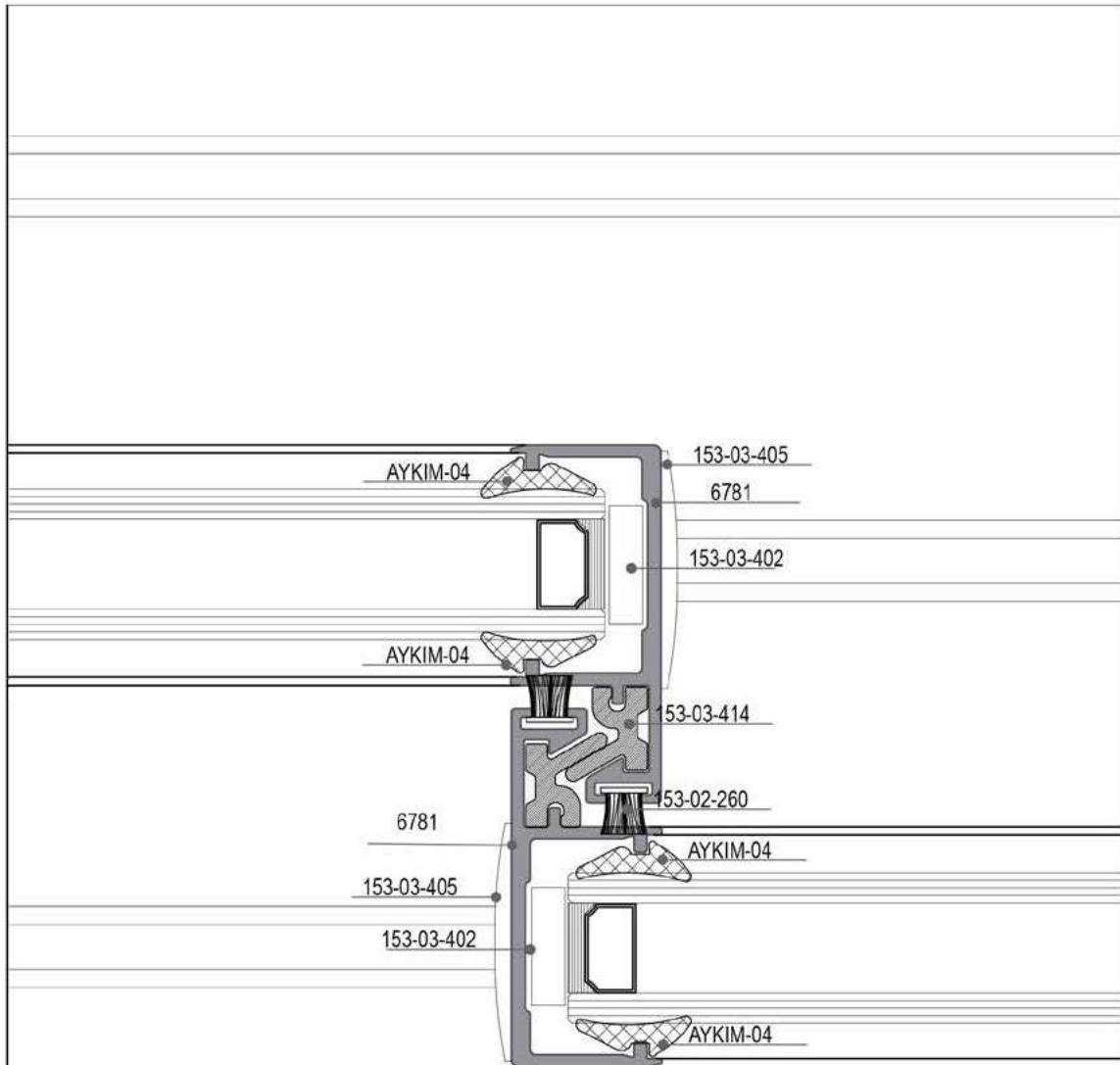
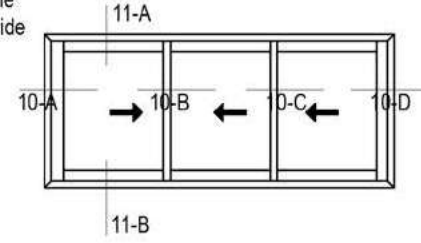
Ölçek: 1:1 Scale: 1:1

90° Klasik Sürme
90° Classical Slide10-C DETAYI
DETAIL

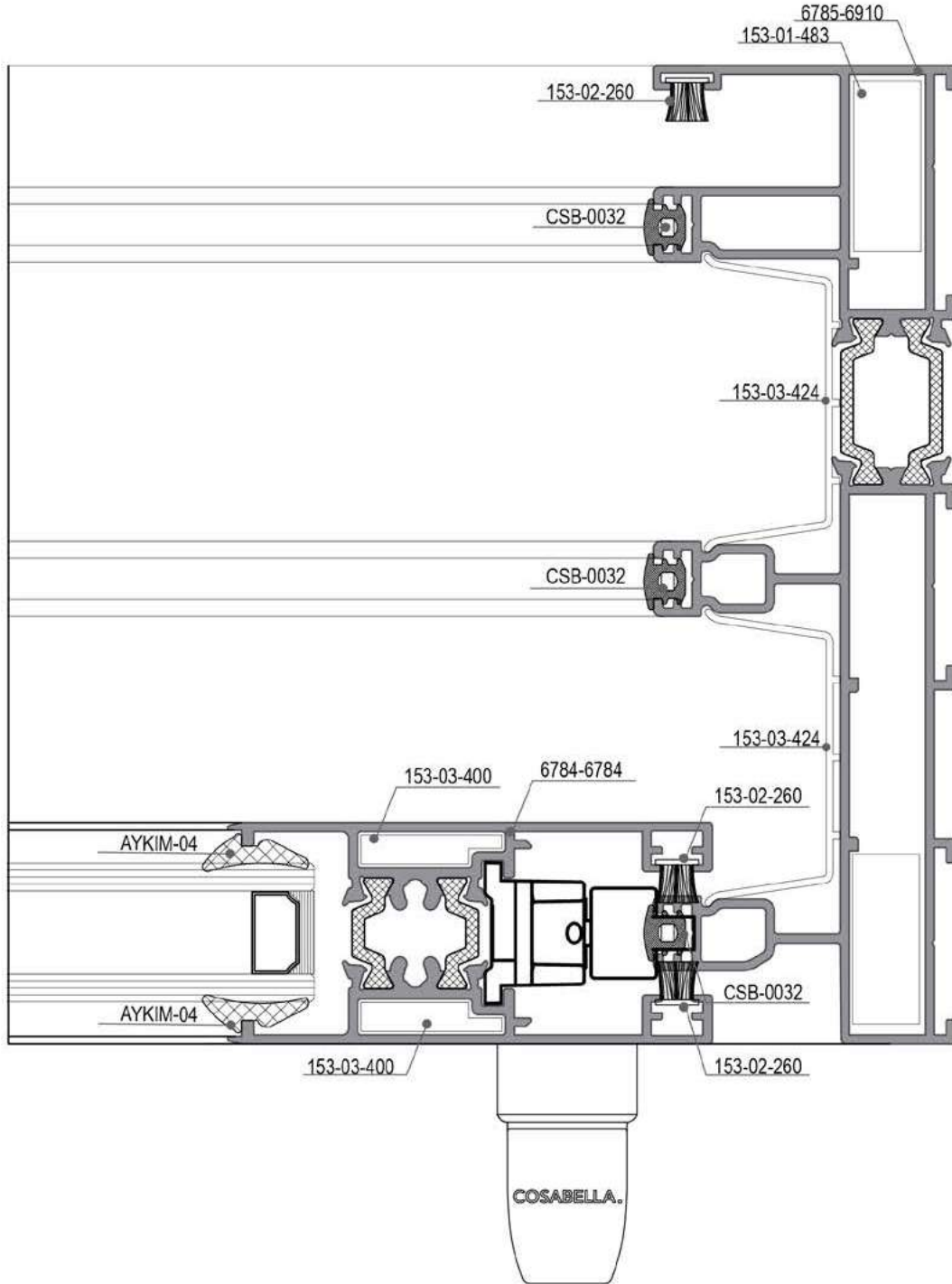
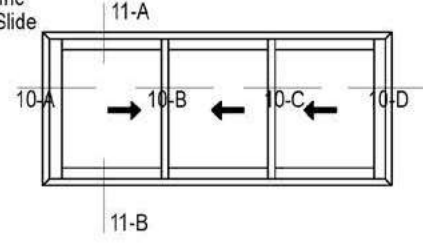
Ölçek: 1:1 Scale: 1:1

90° Klasik Sürme
 90° Classical Slide

 10-D DETAYI
 DETAIL

Ölçek: 1:1

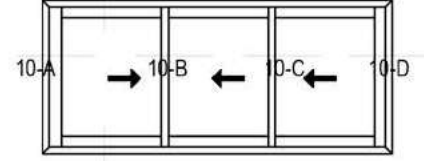
Scale: 1:1

90° Klasik Sürme
90° Classical Slide 1-B

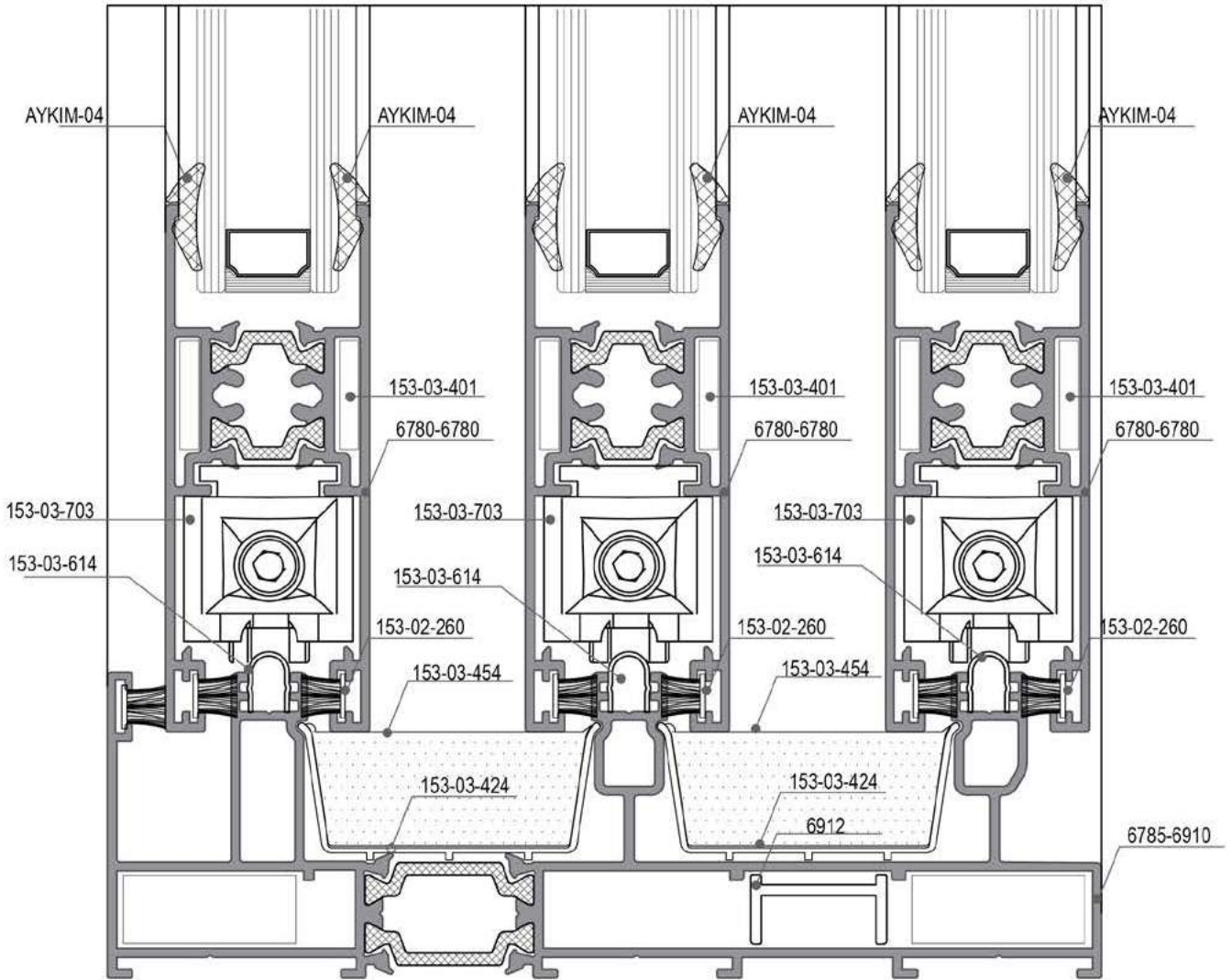
11-A

11-A DETAYI
DETAIL

Ölçek: 1:1 Scale: 1:1

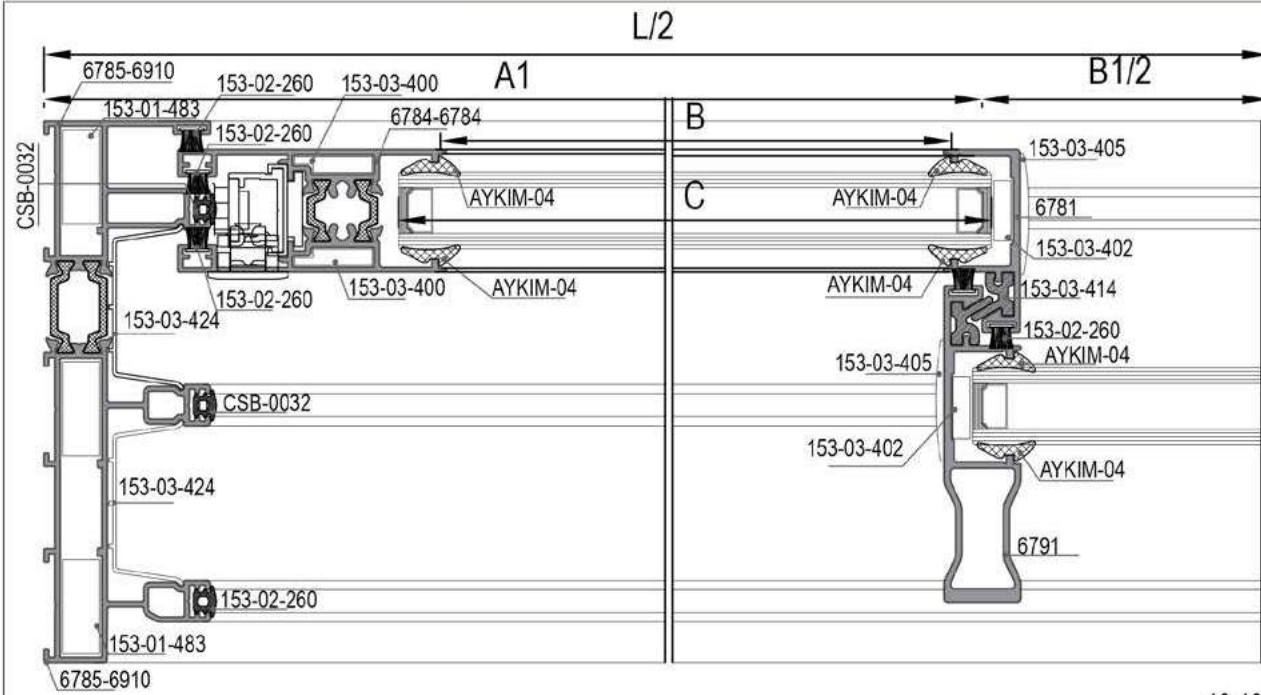

 10-10 DETAYI
 10-10 DETAIL

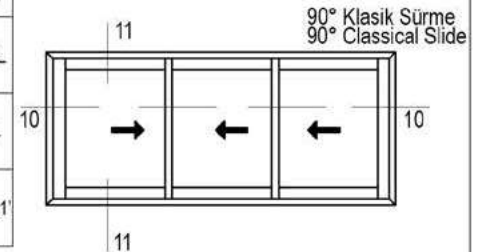
Kasa Genişlik Frame Width	6785-6910			2 Ad. 2 Pcs.	L
Kasa Yükseklik Frame Height	6785-6910			2 Ad. 2 Pcs.	H
Kanat Yükseklik Sash Height	6784-6784			2 Ad. 2 Pcs.	H-76
Yatay Kanat Genişlik Horizontal Sash Width	6780-6780			6 Ad. 6 Pcs.	A-111,12 B-16,16
Kenet Kanat Yükseklik Sash Height	6781			3 Ad. 3 Pcs.	H-76
Kenet Kanat Yükseklik Sash Height	6791			1 Ad. 1 Pcs.	H-76
Kanat Cam Genişlik Glazing Sash Width				3 Ad. 3 Pcs.	C1=A-90,12
Kanat Cam Yükseklik Glazing Sash Height				3 Ad. 3 Pcs.	C1'=H-195
Opsiyon -1 Option -1	153-01-483 Vidalı Köşe Bağ. Takoğu Screwed Corner Cleat	12 Ad. 12 Pcs.		153-03-614 Paslanmaz Çelik Ray Stainless Steel Rail Track	L-75,2 mm. 3 Ad./Pcs.
6784/6784 6780/6780	153-03-400 90° Geniş Köşe Bağlantı 90° Wide Sash Cor.Joint	4 Ad. 4 Pcs.		153-03-703 Ayarlı Rulman Adjustable Roller	6 Ad. 6 Pcs.
6781/6791 6780/6780	153-03-402 90° Dar Köşe Bağlantı 90° Narrow Sash Cor.Joint	8 Ad. 8 Pcs.		153-03-454 Kasa Alt & Üst Tozluk Central Top & Bottom Sealing	2 Tkm. 2 Set.
	153-03-413 Kanat Kenetleme Plastiği Plastic Sash Lock Adapter	Metre Meter H-76,01		153-03-408 Stoplama	4 Ad. 4 Pcs.
	153-03-405 Adaptör Kapağı Alt & Üst Adapter Cap Bottom & Top	8 Adet 8 Pcs.		153-02-260 Fırça Fitol Brush Pile Seal	10H+8L
	153-03-904 90° Kertmeli Kulp Kapak 90° Notched Sash End Cap	1 Tk. 1 Pcs.		CSB-0032 Ray Kapama Contası Gasket For Frame Rails	6H+3L
	153-03-424 Kanal "U" Plastiği Plastic Cover For Frame	L-34 mm. 2 Ad./ Pcs H-34 mm. 2 Ad./Pcs		AYKIM-04 Glazing Wedge Gasket (Cam Tercihine Göre) (Optional Glass Size)	12C1+12C1'

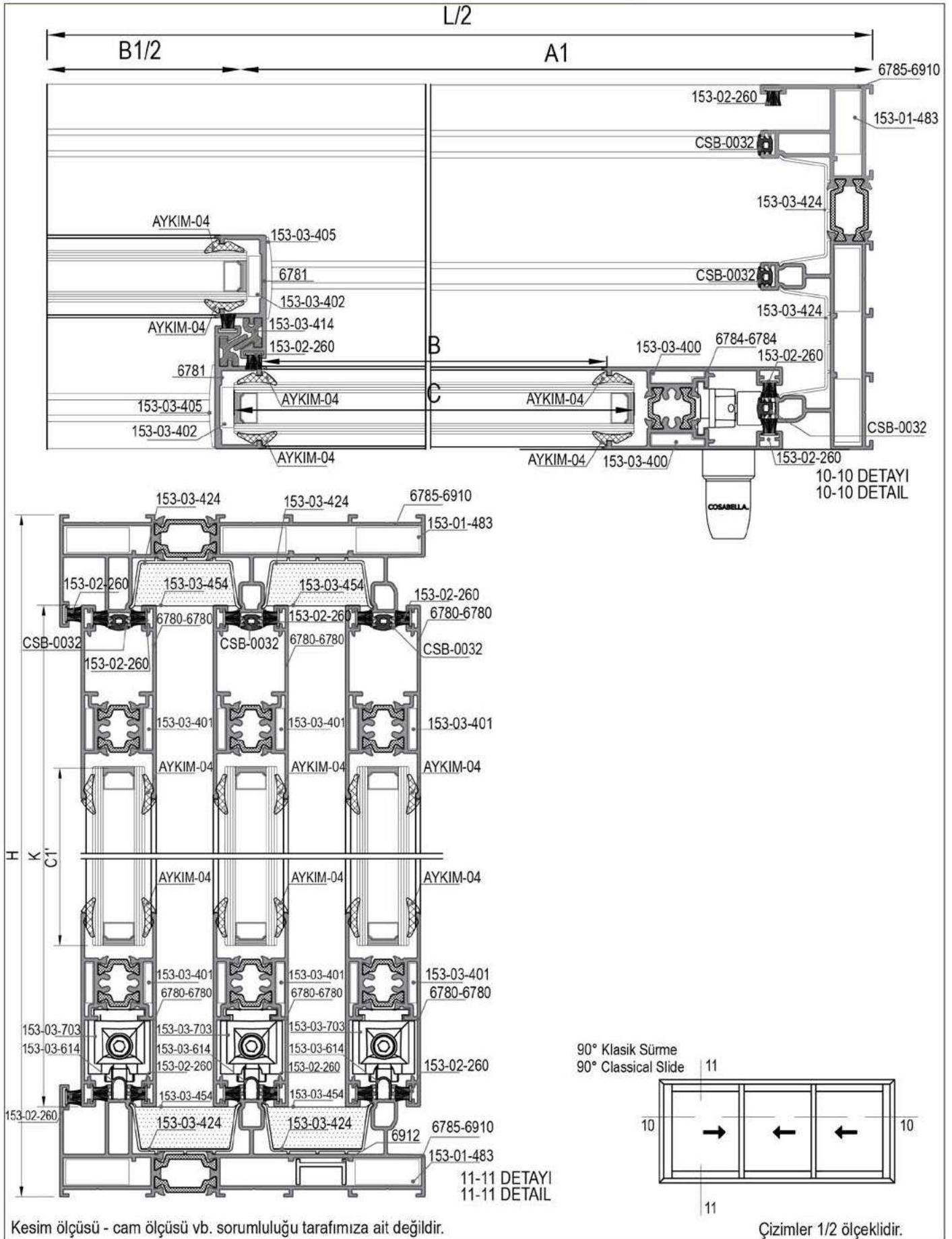

Kesim ölçüsü - cam ölçüsü vb. sorumluluğu tarafımıza ait değildir.

Çizimler 1/2 ölçeklidir.

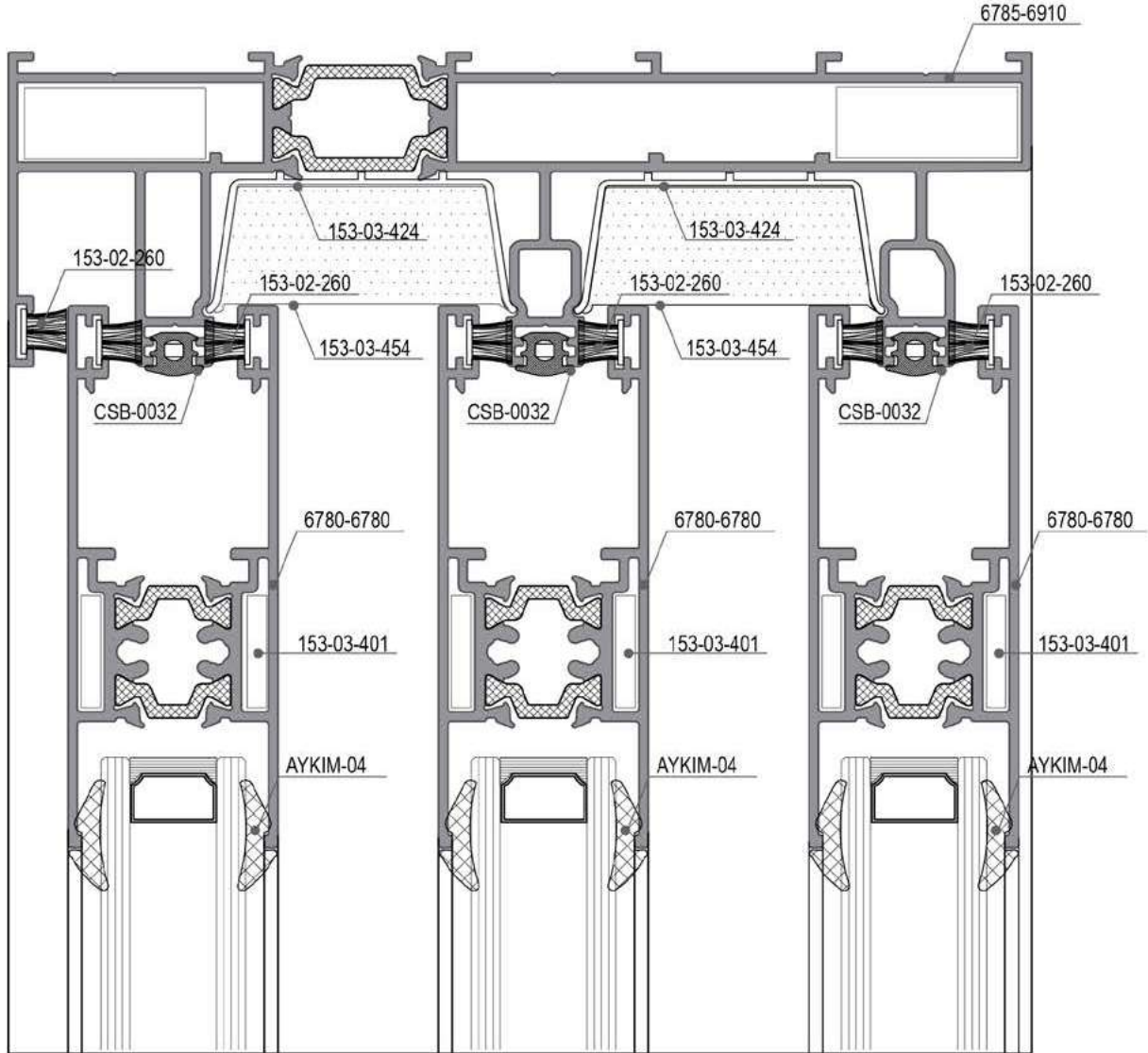
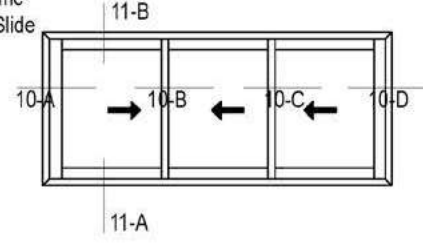

90° Klasik Sürme
 90° Classical Slide

 11-B DETAYI
 DETAIL

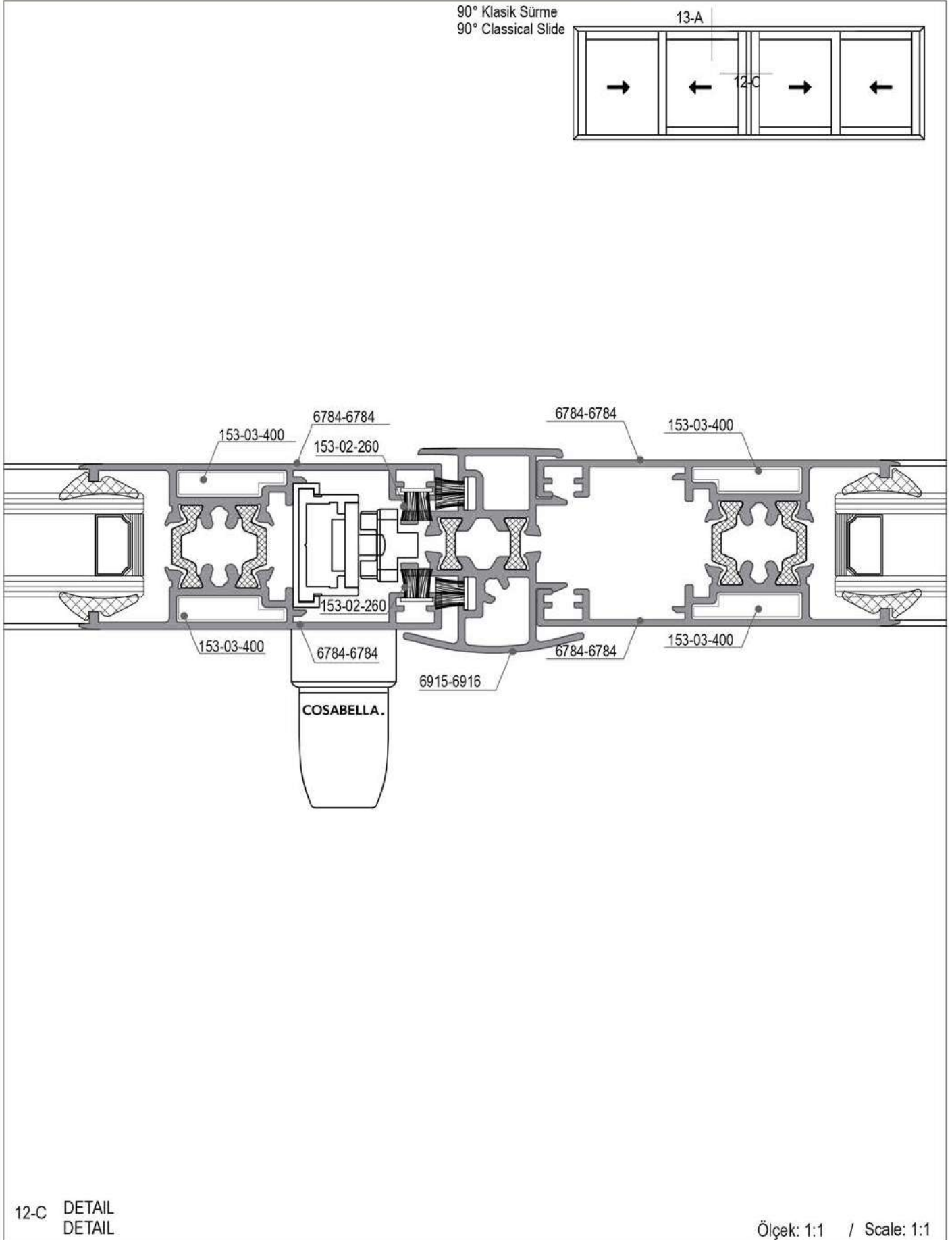
Ölçek: 1:1 Scale: 1:1

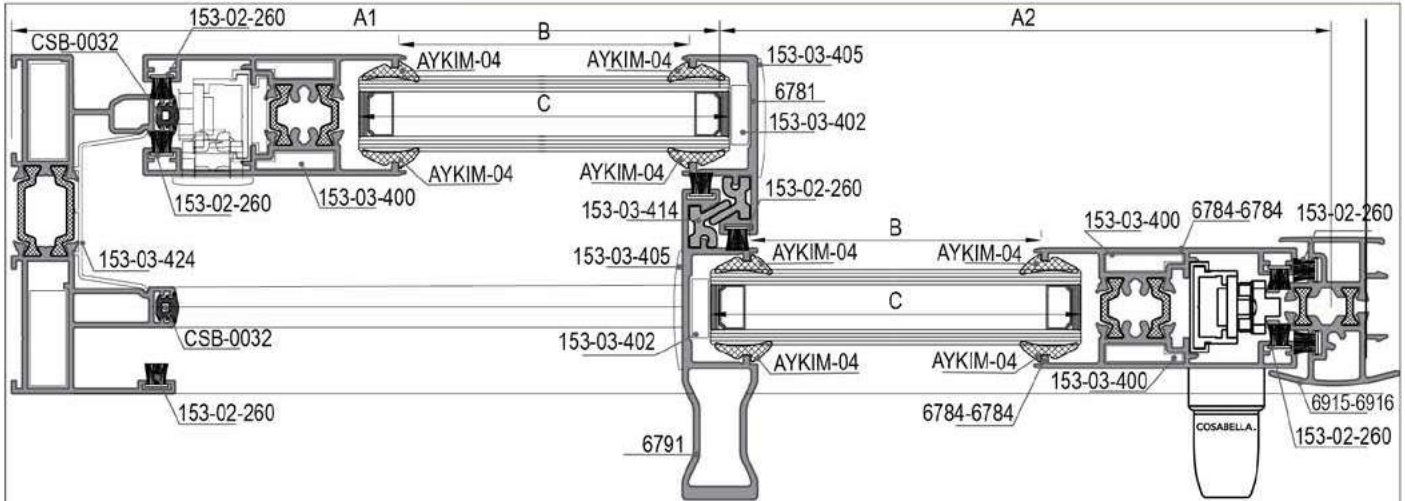



Kasa Genişlik Frame Width	6785-6786			2 Ad. 2 Pcs.	L
Kasa Yükseklik Frame Height	6785-6786			2 Ad. 2 Pcs.	H
Kanat Yükseklik Sash Height	6784-6784			4 Ad. 4 Pcs.	K=H-76
Yatay Kanat Genişlik Horizontal Sash Width	6780-6780			8 Ad. 8 Pcs.	A-111,02 B-85,15
Kenet Kanat Yükseklik Sash Height	6791			2 Ad. 2 Pcs.	H-76
Kenet Kanat Yükseklik Sash Height	6781			2 Ad. 2 Pcs.	H-76
Adaptör Profili Yükseklik Adapter Profile Height	6915-6916			1 Ad. 1 Pcs.	H-106
Kanat Cam Genişlik Glazing Sash Width				1 Ad. 1 Pcs.	A-90,34 B-64,72
Kanat Cam Yükseklik Glazing Sash Height				1 Ad. 1 Pcs.	H-195

Opsiyon -1 Option -1	153-01-483 Vidalı Köşe Bağ. Takozu Screwed Corner Cleat	8 Ad. 8 Pcs.		153-03-424 Kanal "U" Plastiği Plastic Cover For Frame	L-34 mm. 2 Ad./Pcs. H-34 mm. 2 Ad./Pcs.
6784/6784 6780/6780	153-03-400 90° Geniş Köşe Bağlantı 90° Wide Sash Cor.Joint	8 Ad. 8 Pcs.		153-03-614 Paslanmaz Çelik Ray Stainless Steel Rail Track	L-76 mm. 2 Ad./Pcs.
6781 / 6791 6780/6780	153-03-402 90° Dar Köşe Bağlantı 90° Narrow Sash Cor.Joint	8 Ad. 8 Pcs.		153-03-703 Ayarlı Rulman Adjustable Roller	8 Ad. 8 Pcs.
	153-03-454 Kasa Alt & Üst Tozluk Top & Bottom Frame Sealing	2 Tkm. 2 Set.		153-03-408 Stoplama	4 Ad. 4 Pcs.
	153-03-405 Adaptör Kapağı Alt & Üst Adapter Cap Bottom & Top	8 Ad. 8 Pcs.		153-02-260 Fırça Fital Brush Pile Seal	6L+14H
	153-03-406 90° Kertmeli Kulp Kapak 90° Notched Sash End Cap	2 Tkm. 2 Set.		CSB-0032 Ray Kapama Contası Gasket For Frame Rails	2L+4H
	153-03-414 Kanat Kenetleme Plastiği Plastic Sash Lock Adapter	Metre Meter (H-76)		AYKIM-03 Glazing Wedge Gasket (Cam Terçine Göre) (Optional Glass Size)	16C+16C2

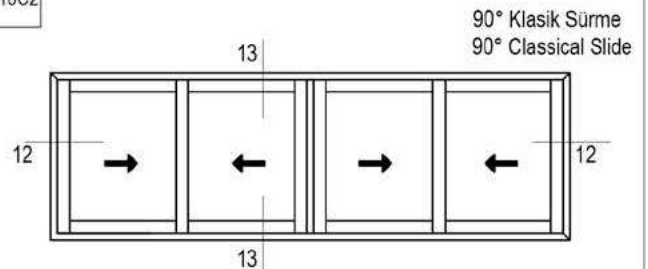
 12-12 DETAYI
 12-12 DETAIL

Kesim ölçüsü - cam ölçüsü vb. sorumluluğu tarafımıza ait değildir.



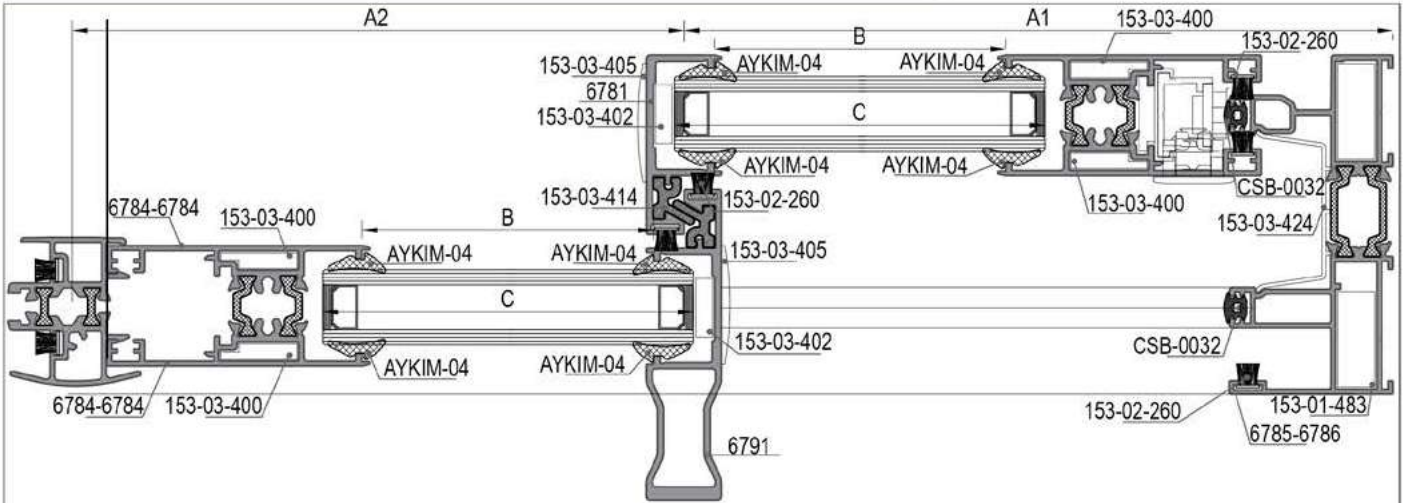
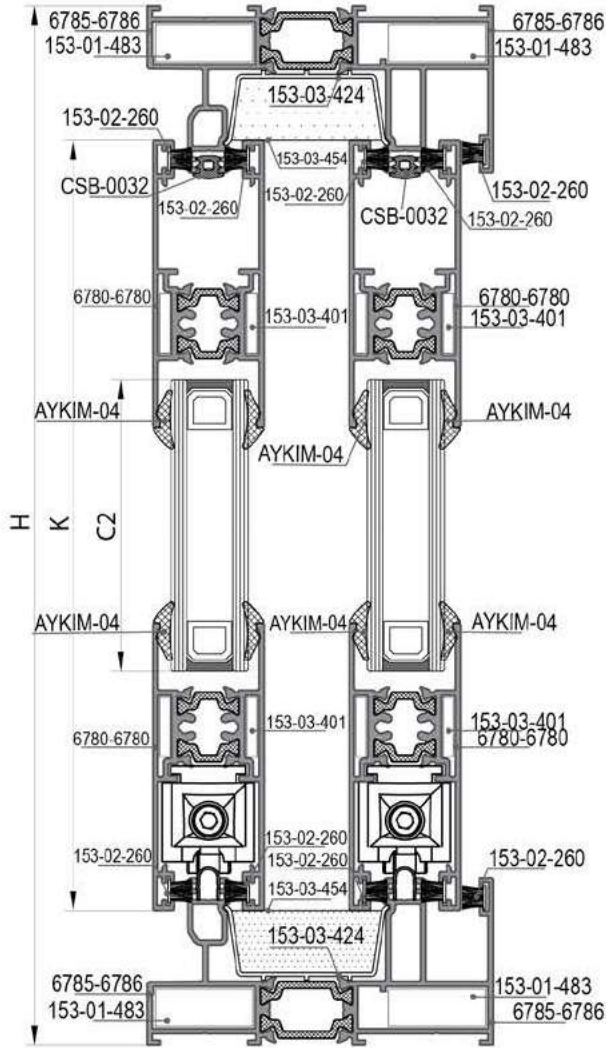
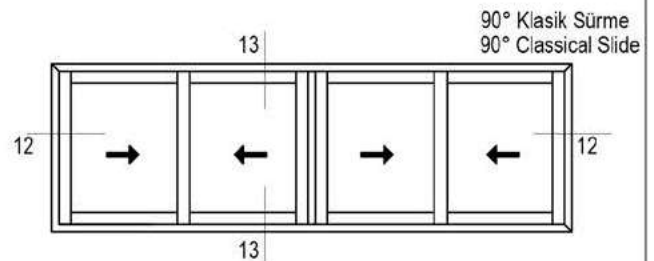

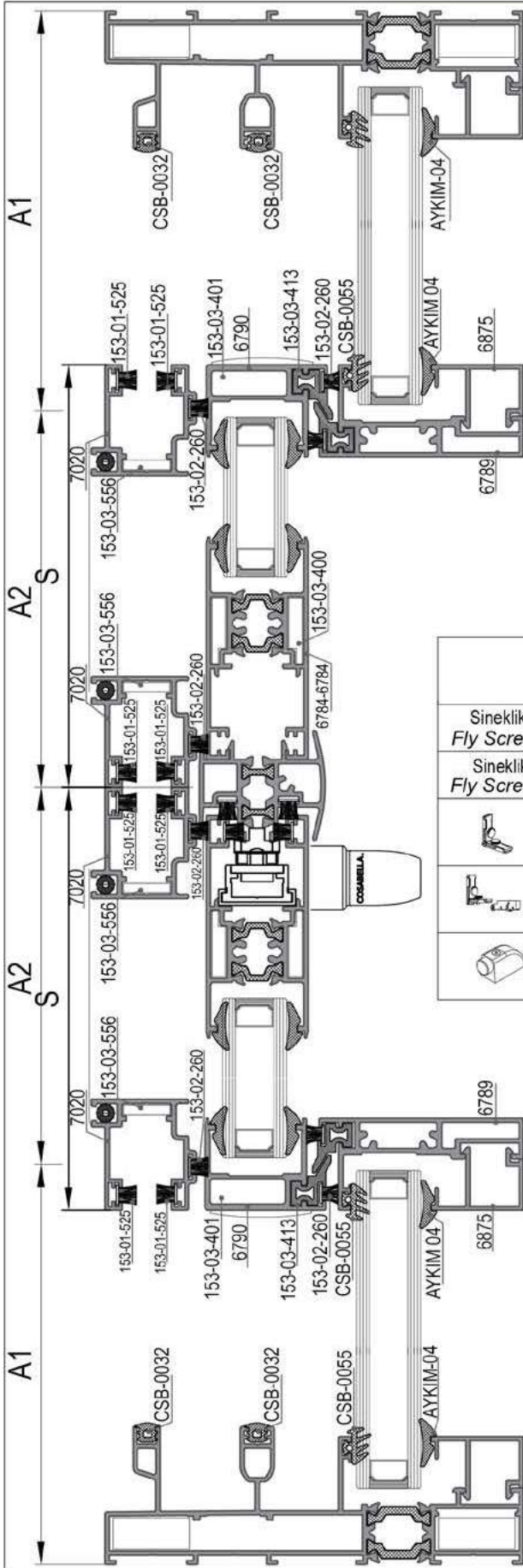
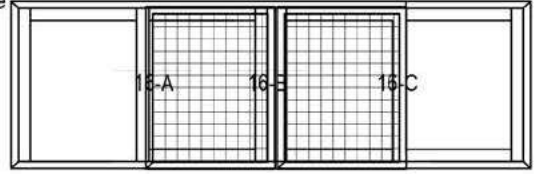

Çizimler 1/2 ölçeklidir.

12-12 DETAYI
12-12 DETAIL13-13 DETAYI
13-13 DETAIL90° Klasik Sürme
90° Classical Slide

Kesim ölçüsü - cam ölçüsü vb. sorumluluğu tarafımıza ait değildir.

Çizimler 1/2 ölçeklidir.



 90° Klasik Sürme
 90° Classical Slide

Sineklik Kanat Yükseklik Fly Screen Sash Height	7020			4 Ad. 4 Pcs.	S'=H-70
Sineklik Kanat Genişlik Fly Screen Sash Width	7020			4 Ad. 4 Pcs.	S=A1+7,11
 153-03-555 45° Köşe Bağlantı 45° Cor.Joint	4 Ad. 4 Pcs.		153-01-525 Fırça Fital Brush Pile Seal	8H+2L	
 153-03-556 45° Makaralı Köşe Bağlantı 45° Cor.Joint	4 Ad. 4 Pcs.		153-02-260 Fırça Fital Brush Pile Seal	4H+2L	
 153-03-722 Sineklik Kanat Stoper Sash Flyscreen Stoper	2 Ad. 2 Pcs.		153-01-886 Sineklik Fitali Flyscreen Gasket	S-55mm. 4 Ad./Pcs. S'-55mm. 4 Ad./Pcs.	



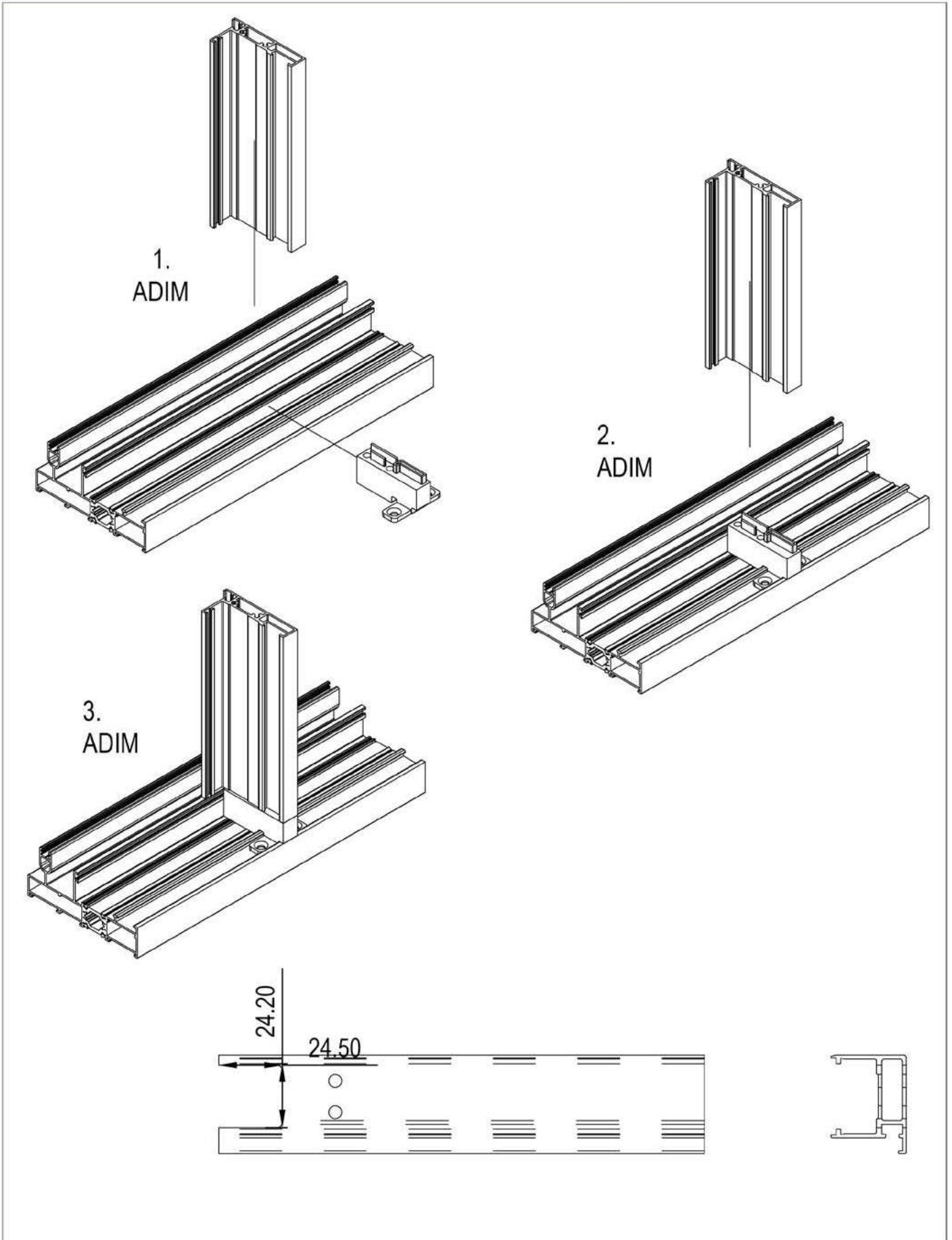

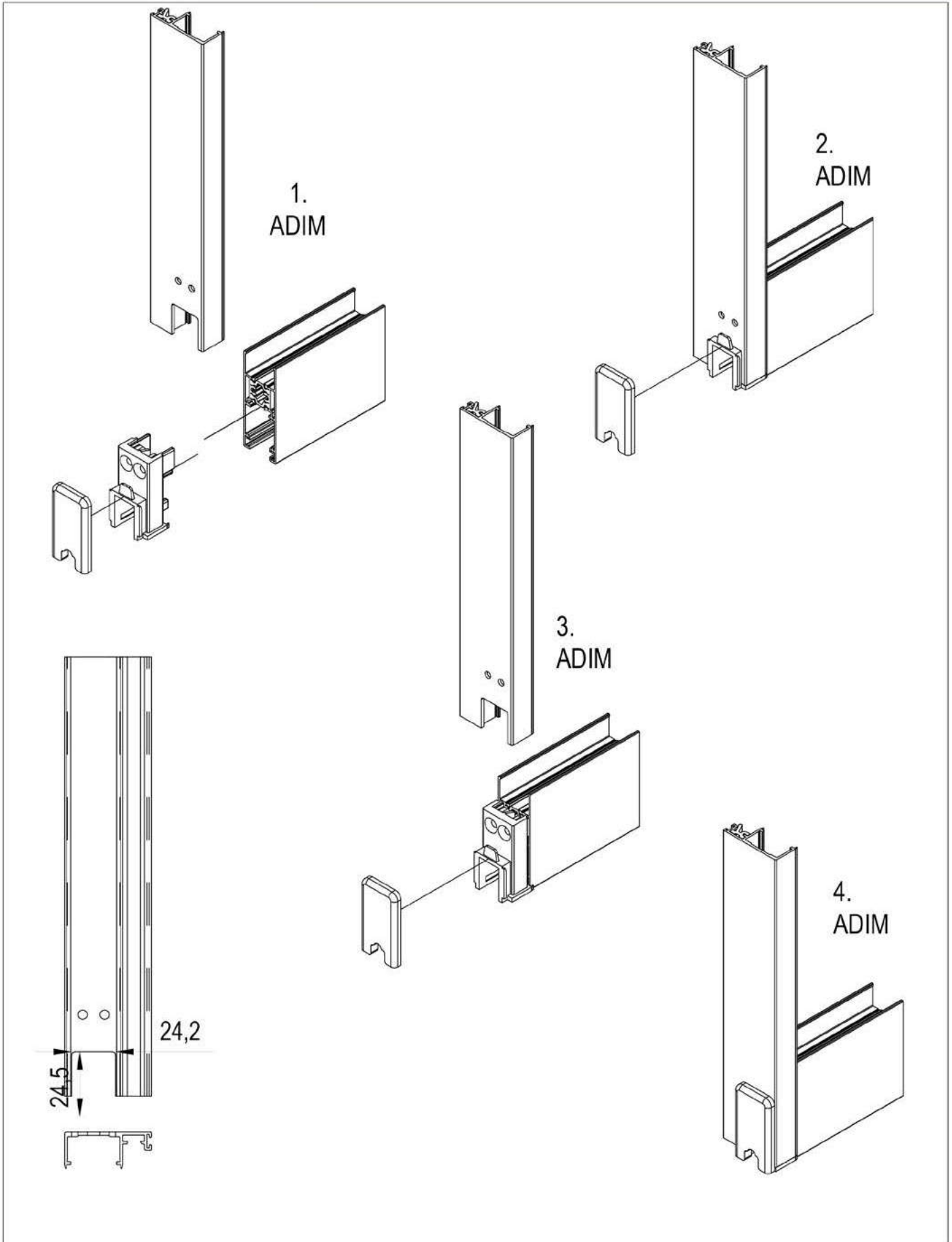

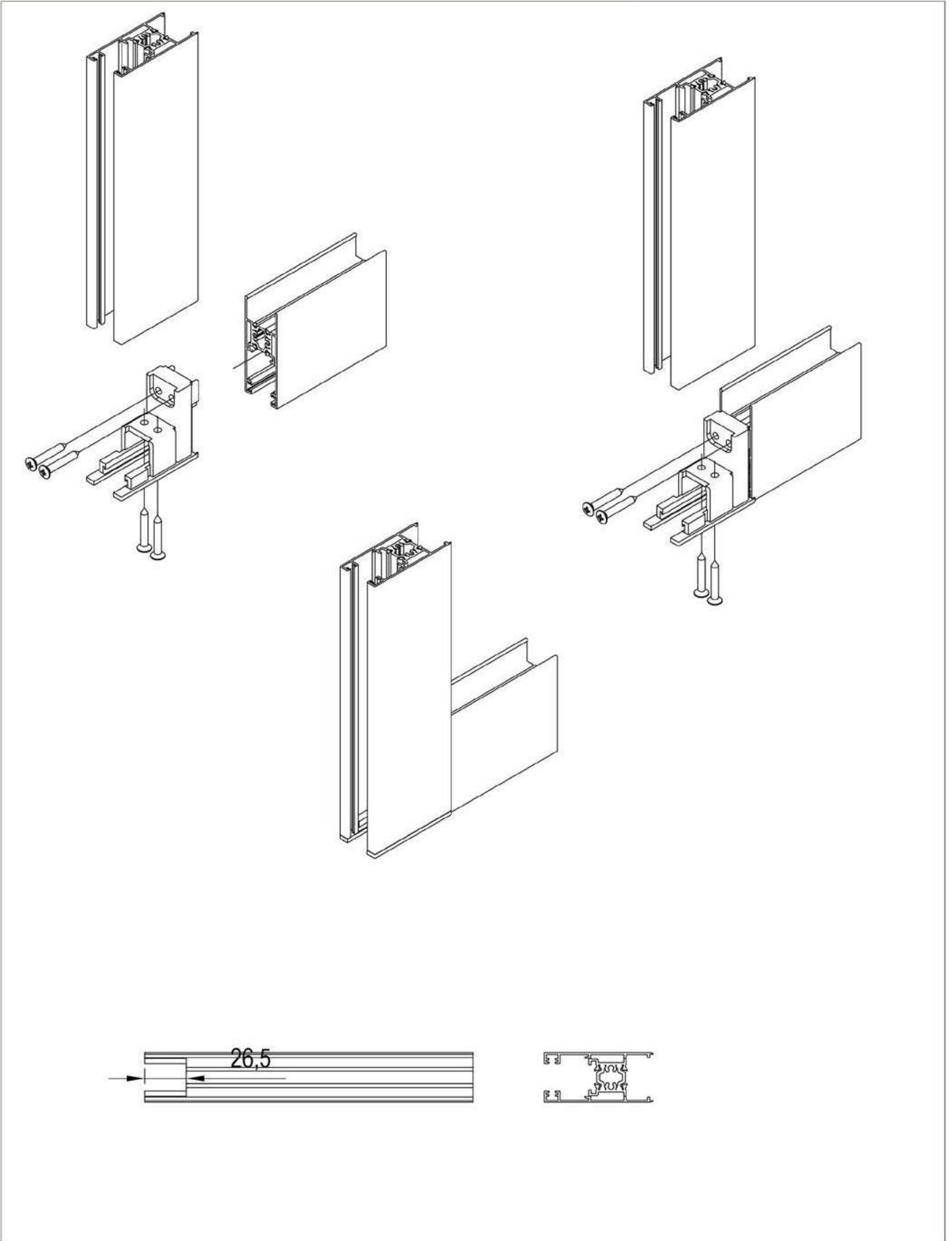

Çizimler Ölçeksizdir.

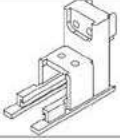

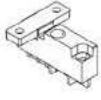
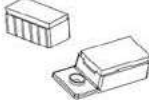
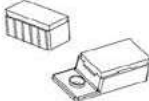









Kesim ölçüsü - cam ölçüsü vb. sorumluluğu tarafımıza ait değildir.

























Ürün Çizimi Drawing	Ürün Kodu Product No	Ürün Adı Product Name	Kullanıldığı Profiller Profiles Used
	153-01-483	Kasa Bağlantı Takazo 11/26 Joint Corner	6788-6787 6785-6910 6788-6909 6785-6786 6785-6913
	153-03-400	153-03-400 90° Geniş Köşe Bağlantı 90° Wide Sash Cor.Joint	6784-6784 6780-6780
	153-03-401	153-03-401 90° Dar Köşe Bağlantı 90° Narrow Sash Cor.Joint	6790 6780-6780
	153-03-402	153-03-402 90° Dar Köşe Bağlantı 90° Narrow Sash Cor.Joint	6781 ve 6791 6780-6780
	153-03-403	153-03-403 90° Dar Köşe Bağlantı 90° Narrow Sash Cor.Joint	6789 6788-6787
	153-03-404	Kasa Alt & Üst Tozluk <i>Central Top & Bottom Sealing</i>	-
	153-03-454	Kasa Alt & Üst Tozluk <i>Central Top & Bottom Sealing</i>	-
	153-03-405	Adaptör Kapağı Alt & Üst Adapter Cap Bottom & Top	-
	153-03-406	90° Kertmeli Kulp Kapak 90° Notched Sash End Cap	-
	153-03-407	Cosabella S322-T 4'lü Kanat Adaptör Kapağı Cosabella S32-T 4 Winged Lid	-
	153-03-408	Stoplama	-
	153-03-703	Ayarlı Rulman Adjustable Roller	-



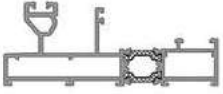
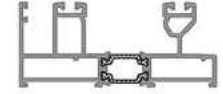

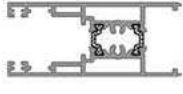
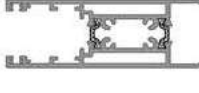
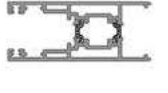

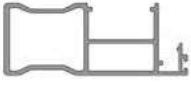
Ürün Çizimi Drawing	Ürün Kodu Product No	Ürün Adı Product Name	Kullanıldığı Profiller Profiles Used
	153-03-409	Sabitleme Takoza	-
	153-03-410	Sabitleme Aparatı	-
	153-03-424	Kanal "U" Plastiği Plastic Cover For Frame	-
	153-03-614	Paslanmaz Çelik Ray Stainless Steel Rail Track	-
	153-03-413	Kanat Kenetleme Plastiği Plastic Sash Lock Adapter	-
	153-03-414	Kanat Kenetleme Plastiği Plastic Sash Lock Adapter	-
	153-03-810	Adaptör Kenetleme Klipsi Plastic Lock Clips	-
	153-01-615 153-03-388 153-03-429	Cosabelle Maçalı Kol Spades Handle 615-Siyah, 388-Gümüş, 429-Beyaz 615-Black, 388-Silver, 429-White	-
	153-03-986	Stac Maçalı Kol Spades Handle 986-Siyah 986-Black	-
	153-03-478	Stac Kıvrık Eksenel Kol Sol Spades Handle 478-Siyah 478-Black	-
	153-03-479	Stac Kıvrık Eksenel Kol Sağ Spades Handle 479-Siyah 479-Black	-
	153-03-802 153-03-813 153-03-815	COSABELLA TİJLİ GÖMME KİLİT COSABELLA MIXED LOCK WITH HINGE 802-renkli, 813-eloksal, 815-beyaz 802-color, 813-silver, 815-white	-

Ürün Çizimi Drawing	Ürün Kodu Product No	Ürün Adı Product Name	Kullanıldığı Profiller Profiles Used
	153-03-801 153-03-812 153-03-814	COSABELLA TİJLİ GÖMME KİLİT KARŞILIĞI 801 renkli, 812 eloksal, 814 beyaz 814 color, 812 silver, 814 white	-
	153-03-317	COSABELLA TİJLİ GÖMME KİLİT PİMİ COSABELLA TIJ MIXED LOCK PIN	-
	153-03-412	COSABELLA TİJLİ SİSTEM KARŞILIĞI COSABELLA EQUIPMENT FOR TIJI SYS.	-
	153-03-420	COSABELLA KİLİTLEME PARÇASI COSABELLA LOCKING PART	-
	153-02-789	Tahliye Tapası Drain Plug	-
	153-01-356	POLYAMİD TİJ POLYAMIDE TIJ	-
	153-03-723	Ayarlı Rulman Adjustable Roller	-
	153-03-722	Sineklik Kanat Stoper Sash Flyscreen Stoper	-
	153-01-525	Fırça Fitol Brush Pile Seal	-
	153-02-260	Fırça Fitol Brush Pile Seal	-
	CSB-0032	Ray Kapama Contası Gasket For Frame Rails	-
	AYKIM-04	Glazing Wedge Gasket (Cam Tercihine Göre) (Optional Glass Size)	-

SD22
SD23
SD32
SD33
SD35
WD42
WD52
FS72

SD33

Profil Profile	Profil Kodu Profile Nr	Ağırlık (kg/m.) Weight (kg/m.)	X mm.	Y mm.	Jx cm ⁴	Jy cm ⁴
	6871-6788 Tekli Kasa Profili Frame Profile	1,698kg/m	111,1 mm	43,5 mm	70,63	8,06
	6867-6868 Sürme Kasa Profili Frame Profile	1,778kg/m	102,2 mm	43,5 mm	60,96	12,61
	6867-7006 Sineklikli Kasa Pr. Frame Profile	2,220kg/m	134,48 mm	43,5 mm	134,31	15,79
	6867-7007 Üçlü Kasa Profili Frame Profile	2,532kg/m	157,04mm	43,5 mm	134,31	17,87
	6876-6876 Kilit Kanat Profili Sash Profile	1,724kg/m	90 mm	38 mm	33,99	12,84
	6866-6866 Yatay Kanat Pr. Sash Profile	1,925kg/m	102,5 mm	35 mm	49,97	13,30
	7185-7185 45° Kanat Pr. 45° Sash Pr.	1,707kg/m	92,5 mm	38 mm	34,29	13,07
	7186 Adaptör Profili Adapter Profile	0,576kg/m	36,74 mm	53,7 mm	6,56	1,89
	6870 Takviyeli Kenet Kanat Profili Sash Profile	1,349kg/m	95 mm	37 mm	46,29	7,32
	6869 Takviyesiz Kenet Kanat Profili Sash Profile	0,756kg/m	53,2 mm	37 mm	8,80	2,70
	6873 Kenet Kanat Pr. Sash Profile	0,664kg/m	44 mm	37 mm	5,57	2,67

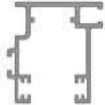
Profil Profile	Profil Kodu Profile Nr	Ağırlık (kg/m.) Weight (kg/m.)	X mm.	Y mm.	Jx cm ⁴	Jy cm ⁴
	6874 Orta Kayıt Pr. Middle Transom Pr.	0,942kg/m	69,6 mm	37 mm	15,47	2,57
	7008-7009 Orta Kilitleme Pr. Adapter Profile	1,048kg/m	32,17 mm	45,53mm	-	-
	6875 Cam Çita Profili Glazing Bread Pr.	0,272kg/m	29 mm	19,98 mm	0,8	0,3
	6865 Adaptör Profili Adapter Profile	0,541kg/m	69,6 mm	23,6 mm	13,09	0,84
	6872 Adaptör Profili Adapter Profile	0,467kg/m	69,6 mm	18,6 mm	9,32	0,38
	7106 Sineklik Profili Fly Screen Profile	0,522kg/m	31,8 mm	43,5 mm	-	-
	7020 Sineklik Kanat Pr. Fly Screen Profile	0,825 kg/m	33,15 mm	35 mm	-	-

Sürme Tekli Kasa Profili - Sliding Frame Profile

6871-6788

1,698 kg/m

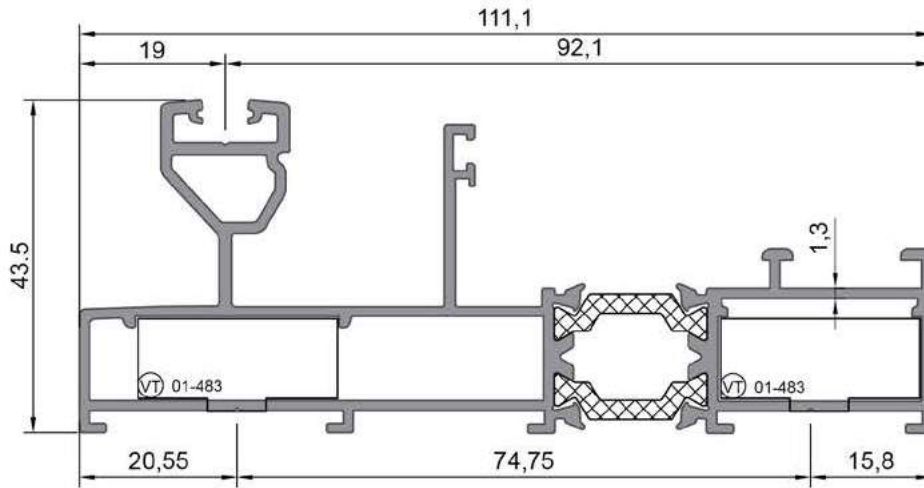

6871-6788

Kod/Code	Et Kalın./Wall Thk.	Ürün Adı / Prod. Name	Ağırlığı / Weight	Köşe Takozu / C. Cleat
6871-6788	1,3 mm	Tekli Kasa Pr. / Single Frame Profile	1,698 kg/m	-

Sürme Kasa Profili- Sliding Frame Profiles

6867-6868

1,778 kg/m

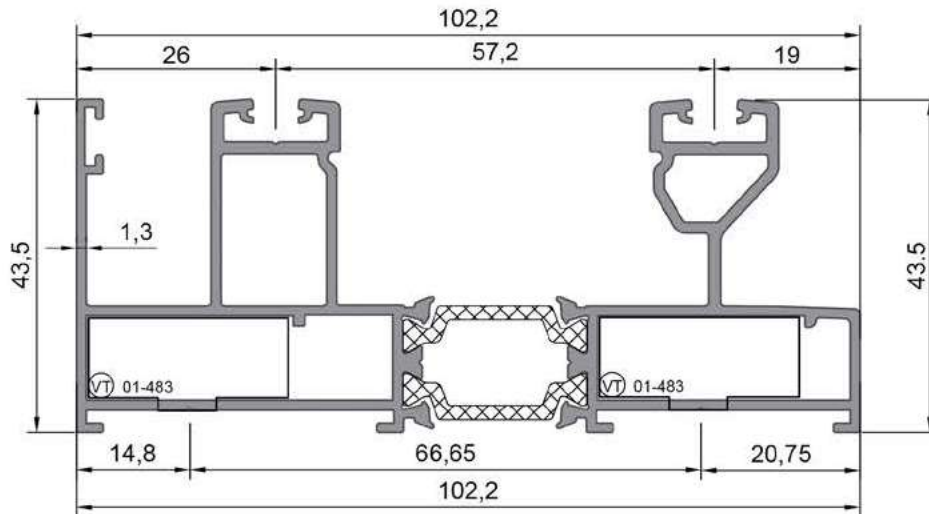

6867-6868

Kod/Code	Et Kalın./Wall Thk.	Ürün Adı / Prod. Name	Ağırlığı / Weight	Köşe Takozu / C. Cleat
6867-6868	1,3 mm	Sürme Kasa Pr. / Sliding Frame Pr.	1,778 kg/m	-

Sineklikli Sürme Kasa Profili - Sliding Frame Profile

6867-7006

2,220 kg/m

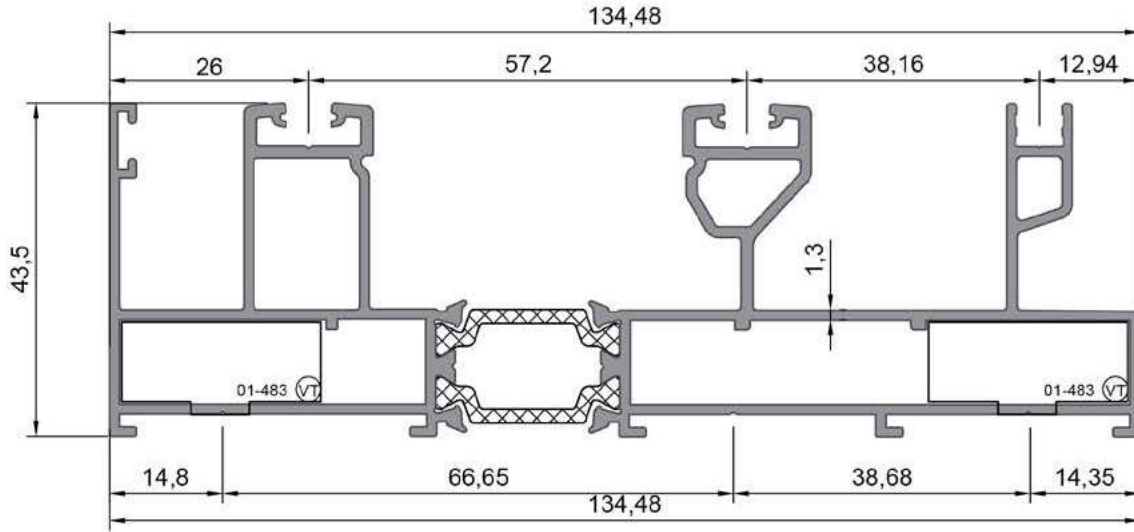

6867-7006

Kod/Code	Et Kalın./Wall Thk.	Ürün Adı / Prod. Name	Ağırlığı /Weight	Köşe Takozu / C. Cleat
6867-7006	1,3 mm	Sineklikli Kasa Pr. / Fly Screen Frame Pr.	2,220 kg/m	-

Üçlü Sürme Kasa Profili- Sliding Frame Profiles

6867-7007

2,532 kg/m

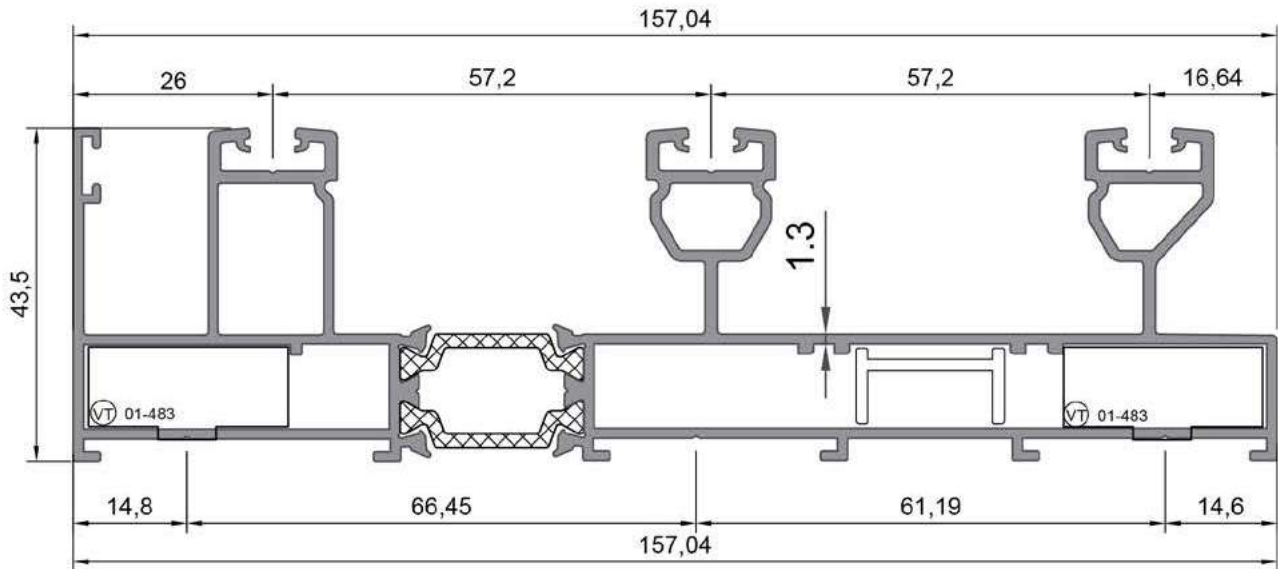

6867-7007

Kod/Code	Et Kalın./Wall Thk.	Ürün Adı / Prod. Name	Ağırlığı /Weight	Köşe Takozu / C. Cleat
6867-7007	1,3 mm	Üçlü Kasa Pr. / Triple Frame Pr.	2,532 kg/m	-

Kanat Profili - Sash Profile

6876-6876

1,724 kg/m

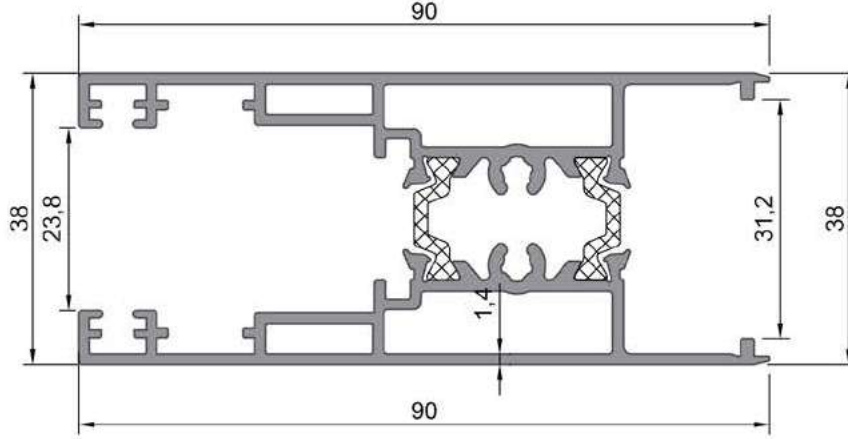

6876-6876

Kod/Code	Et Kalın./Wall Thk.	Ürün Adı / Prod. Name	Ağırlığı / Weight	Köşe Takozu / C. Cleat
6876-6876	1,4 mm	Kilit Kanat Pr. / Locking Sash Profile	1,724 kg/m	-

Yatay Kanat Profili-Horizontal Sash Profile

6866-6866

1,925 kg/m

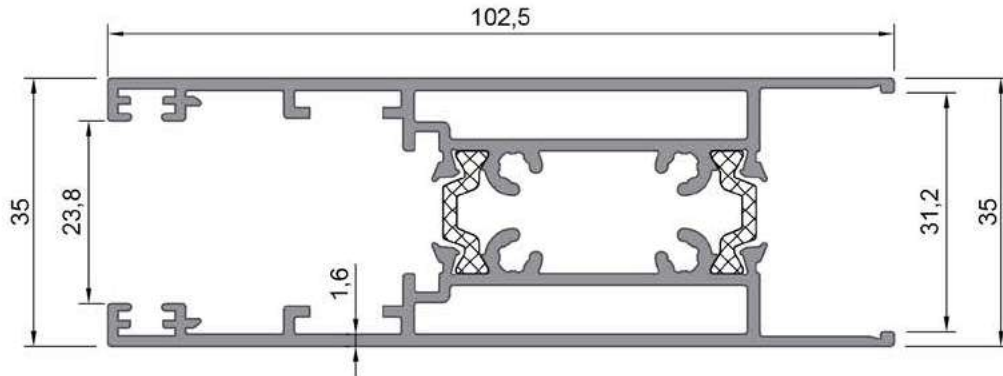

6866-6866

Kod/Code	Et Kalın./Wall Thk.	Ürün Adı / Prod. Name	Ağırlığı / Weight	Köşe Takozu / C. Cleat
6866-6866	1,6 mm	Yatay Kanat Pr. / Horizontal Sash Pr.	1,925 kg/m	-

45° Kanat Profili - Sash Profile
 7185-7185
 1,707 kg/m

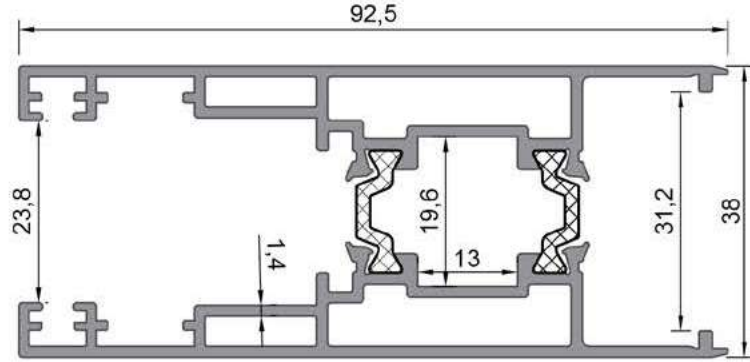

7185-7185

Kenet Profili - Sash Profile
 7186
 0,576 kg/m

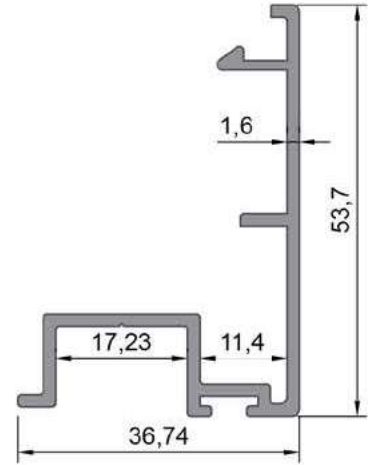

7186

Kod/Code	Et Kalın./Wall Thk.	Ürün Adı / Prod. Name	Ağırlığı / Weight	Köşe Takoğu / C. Cleat
7185-7185	1,4 mm	45° Kanat Pr. / 45° Sash Profile	1,707 kg/m	-
7186	1,6 mm	Adaptör Pr. / Adapter Profile	0,576 kg/m	-

Takviyeli Kenet Profili - Sash Profile
 6870
 1,349 kg/m

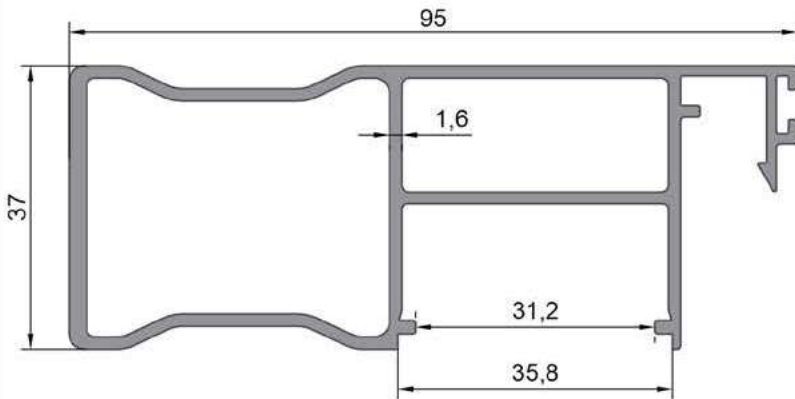

6870

Takviyesiz Kenet Profili - Sash Profile
 6869
 0,756 kg/m

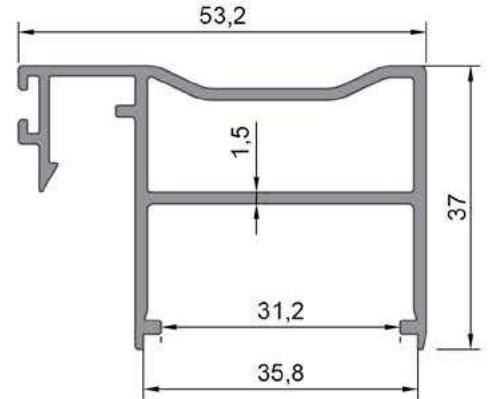

6869

Kod/Code	Et Kalın./Wall Thk.	Ürün Adı / Prod. Name	Ağırlığı / Weight	Köşe Takoğu / C. Cleat
6870	1,6 mm	Takviyeli Kanat / Reinforced Sash Profile	1,349 kg/m	-
6869	1,5 mm	Takviyesiz Kanat / Non-Reinforced Sash Pr.	0,756 kg/m	-

Monoray Kenet Kanat Profili - Sash Profile
6873
0,664 kg/m

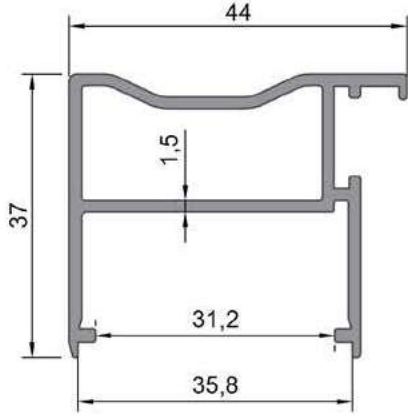

6873

Monoray Orta Kayıt Profili - Middle Transom Profile
6874
0,942 kg/m

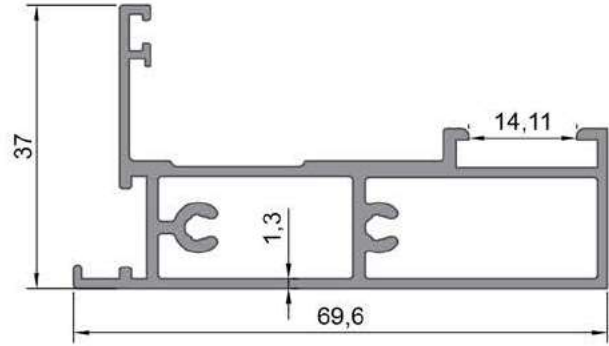

6874

Kod/Code	Et Kalın./Wall Thk.	Ürün Adı / Prod. Name	Ağırlığı / Weight	Köşe Takozu / C. Cleat
6873	1,5 mm	Kenet Kanat Pr. / Interlock Sash Profile	0,664 kg/m	-
6874	1,3 mm	Orta Kayıt Pr. / Middle Transom Profile	0,942 kg/m	-

Orta Kilitleme Profili - Center Locking Profile
7008-7009
1,048 kg/m

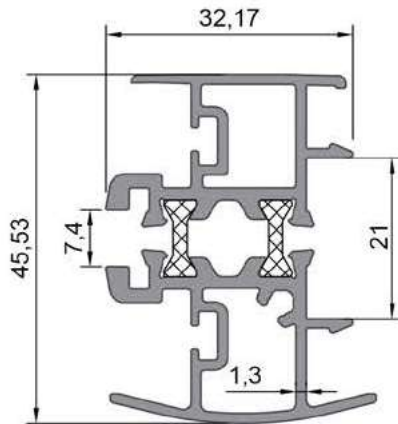

7008-7009

Cam Çıta Profili - Glazing Bead Profile
6875
0,272 kg/m

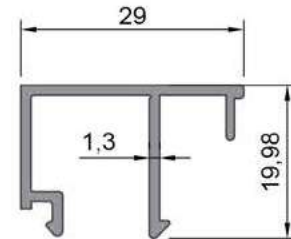

6875

Kod/Code	Et Kalın./Wall Thk.	Ürün Adı / Prod. Name	Ağırlığı / Weight	Köşe Takozu / C. Cleat
7008-7009	1,3 mm	Orta Kilitleme Pr. / Center Locking Profile	1,048 kg/m	-
6875	1,3 mm	Cam Çıta / Glazing Bead Profile	0,272 kg/m	-

Tekli Kasa Adaptör Profili - Adapter Profile
 6865
 0,541 kg/m

Tekli Kasa Adaptör Profili - Adapter Profile
 6872
 0,467 kg/m

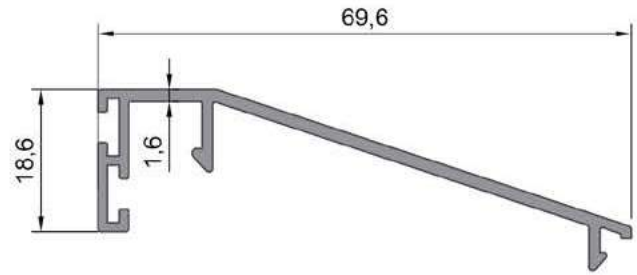
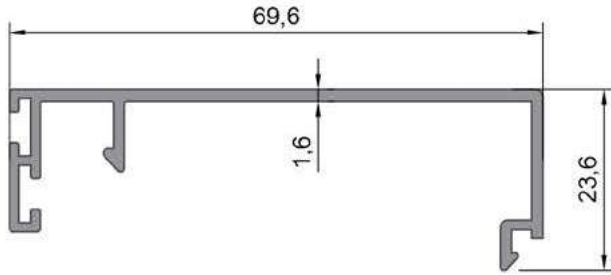
6865
6872

Kod/Code	Et Kalın./Wall Thk.	Ürün Adı / Prod. Name	Ağırlığı / Weight	Köşe Takozu / C. Cleat
6865	1,6 mm	Adaptör Pr. / Adapter Profile	0,541 kg/m	-
6872	1,6 mm	Adaptör Pr. / Adapter Profile	0,467 kg/m	-

Sineklik Kasa Profili-Fly Screen Frame Profile
 7106
 0,522 kg/m

Sineklik Kanat Profili-Fly Screen Profile
 7020
 0,532 kg/m

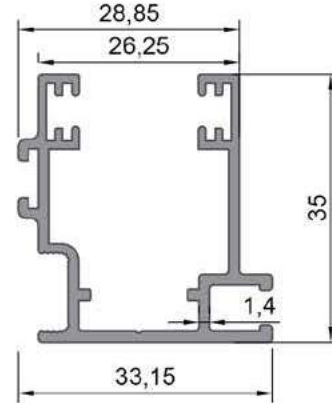
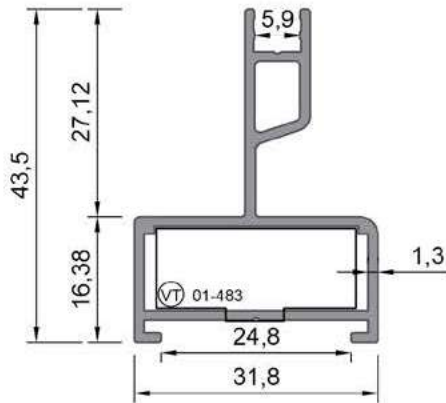
7106
7020

Kod/Code	Et Kalın./Wall Thk.	Ürün Adı / Prod. Name	Ağırlığı / Weight	Köşe Takozu / C. Cleat
7106	1,3 mm	Sineklik Kasa Pr. / Fly Screen Frame Profile	0,522 kg/m	-
7020	1,4 mm	Sineklik Pr. / Fly Screen Profile	0,532 kg/m	-

90° Klasik Tek Ray Sürme

90° Classical Monorail Slide

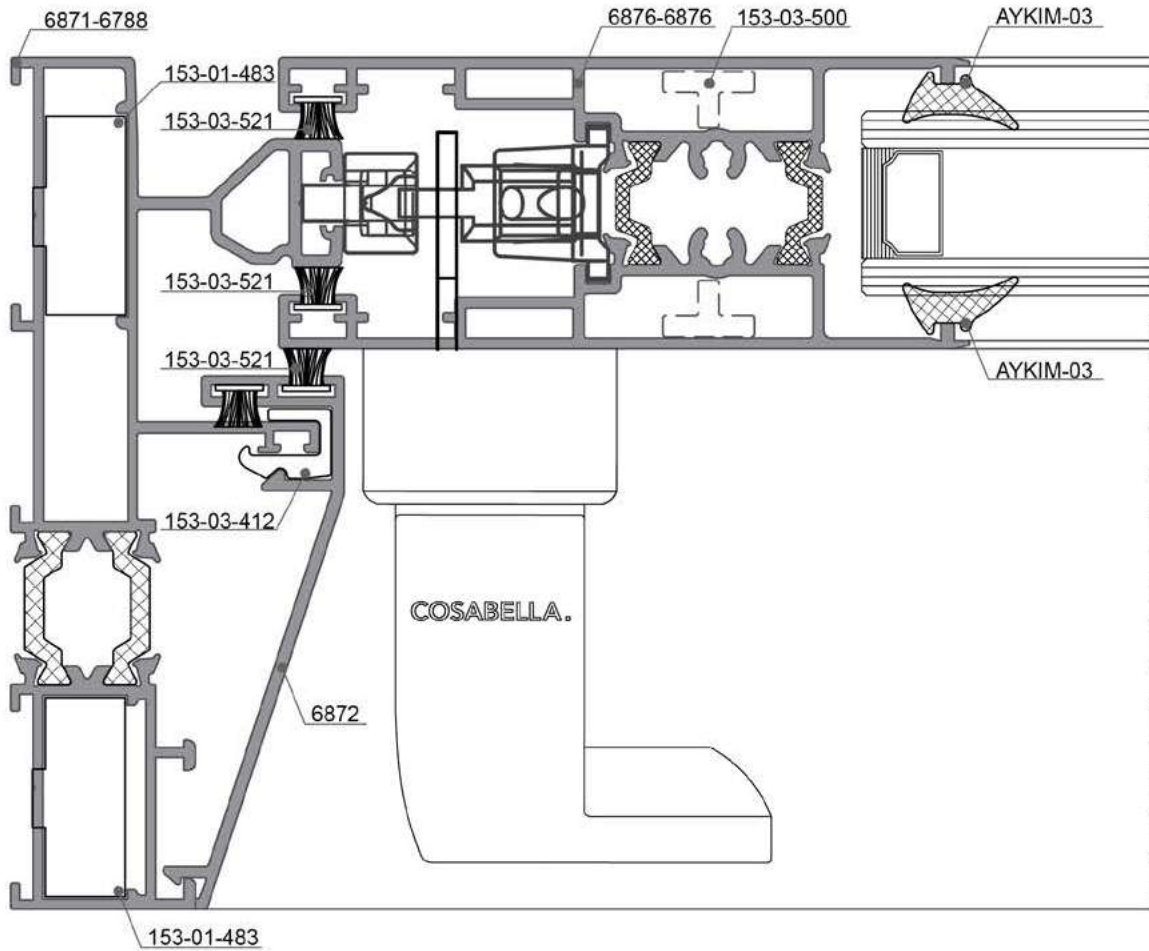
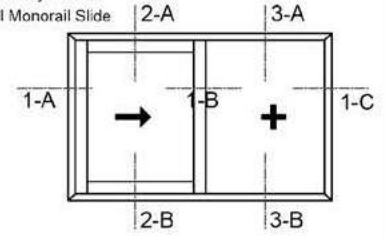
 1-A DETAYI
 DETAIL

Ölçek: 1:1 / Scale: 1:1

90° Klasik Tek Ray Sürme

90° Classical Monorail Slide

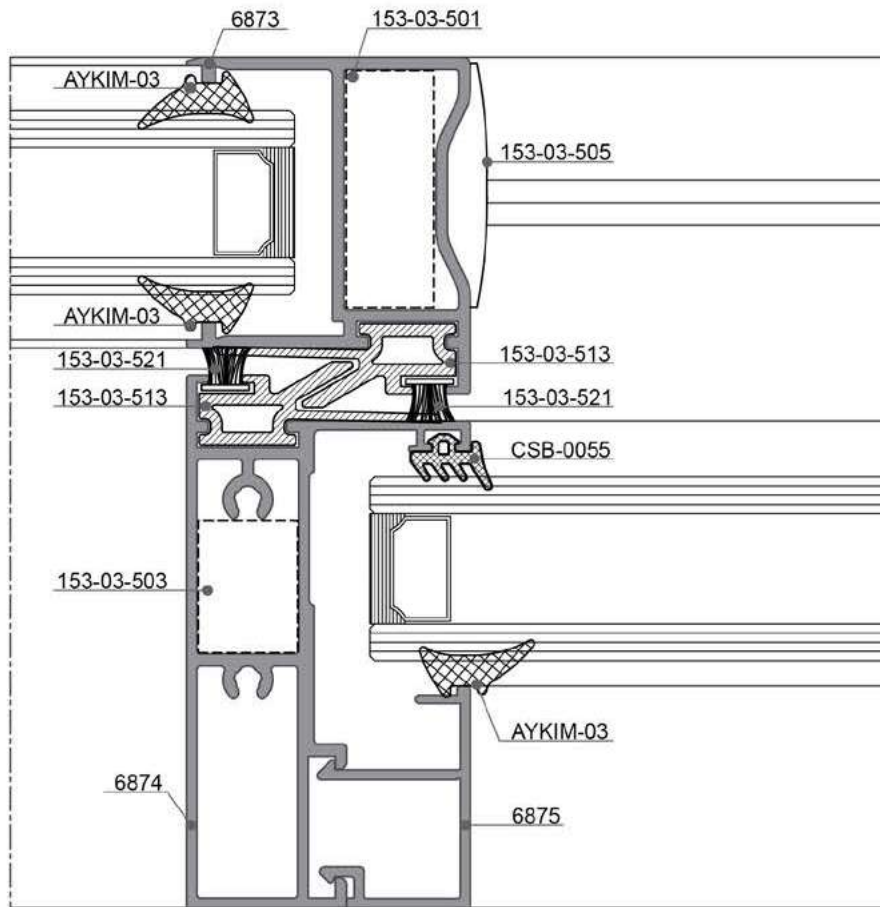
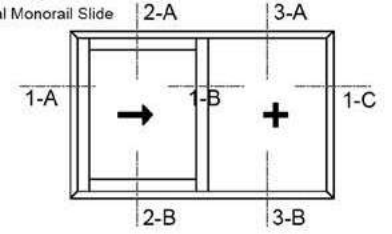
 1-B DETAYI
 DETAIL

Ölçek: 1:1 / Scale: 1:1

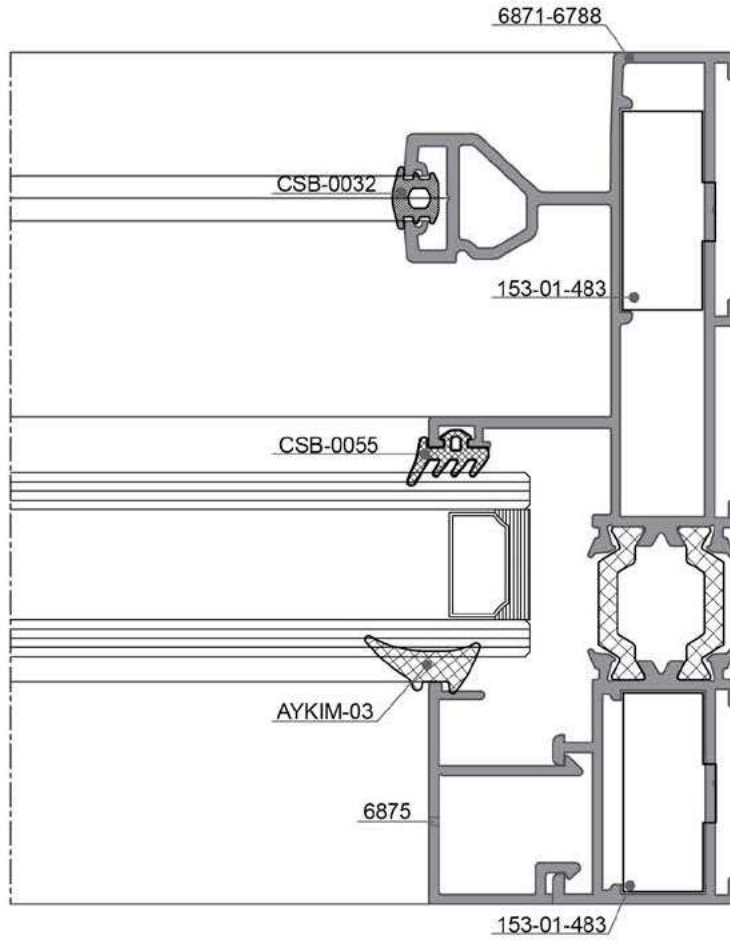
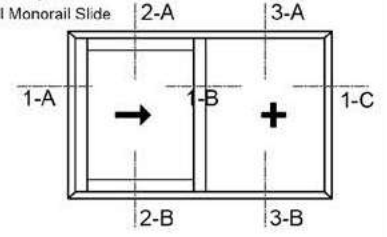
90° Klasik Tek Ray Sürme
 90° Classical Monorail Slide

 1-C DETAYI
 DETAIL

Ölçek: 1:1 / Scale: 1:1

90° Klasik Tek Ray Sürme

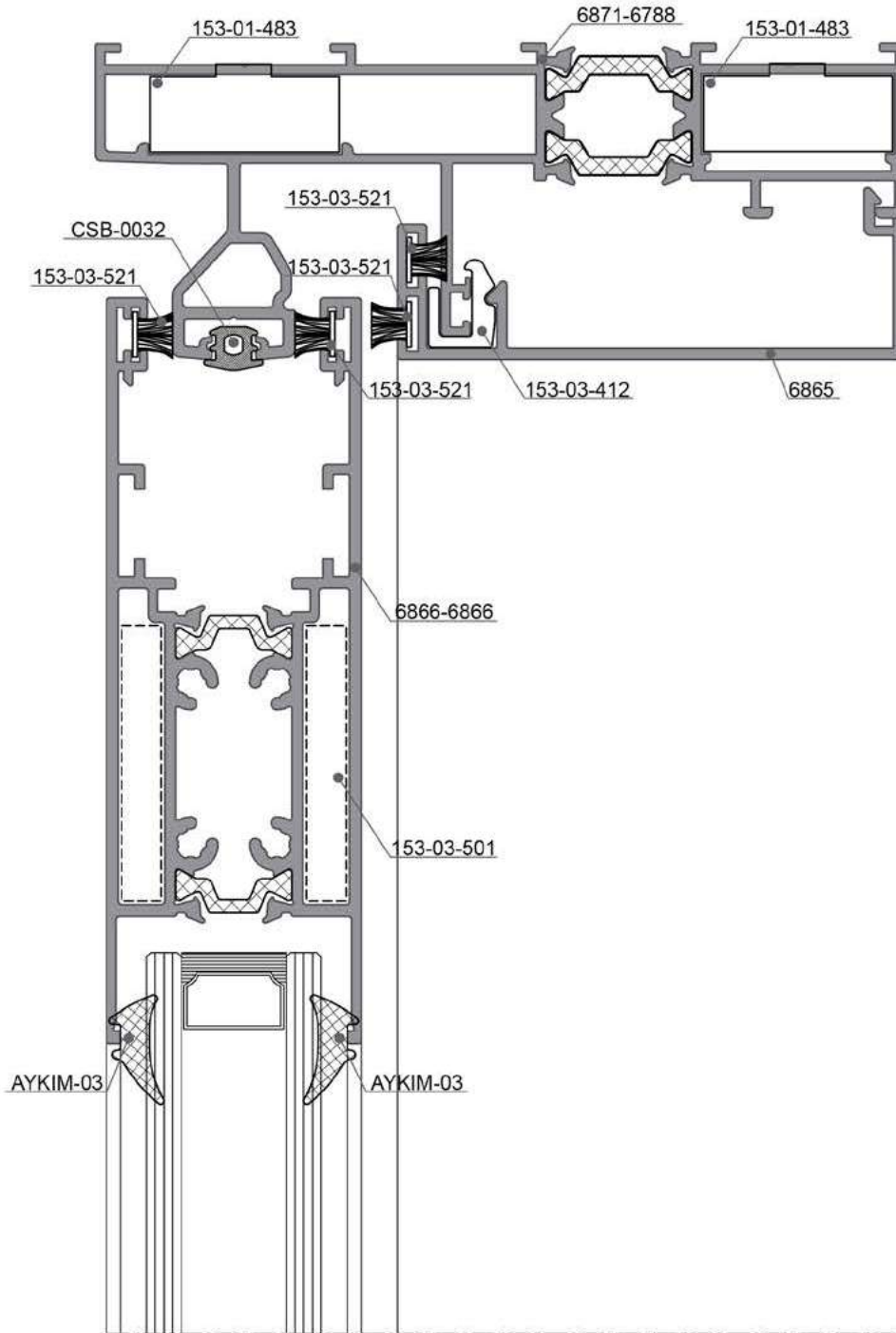
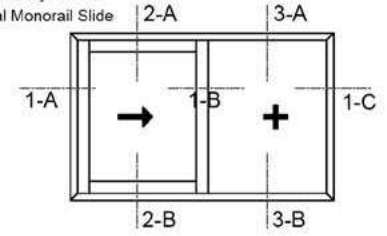
90° Classical Monorail Slide

 2-A
 DETAYI
 DETAIL

Ölçek: 1:1 / Scale: 1:1

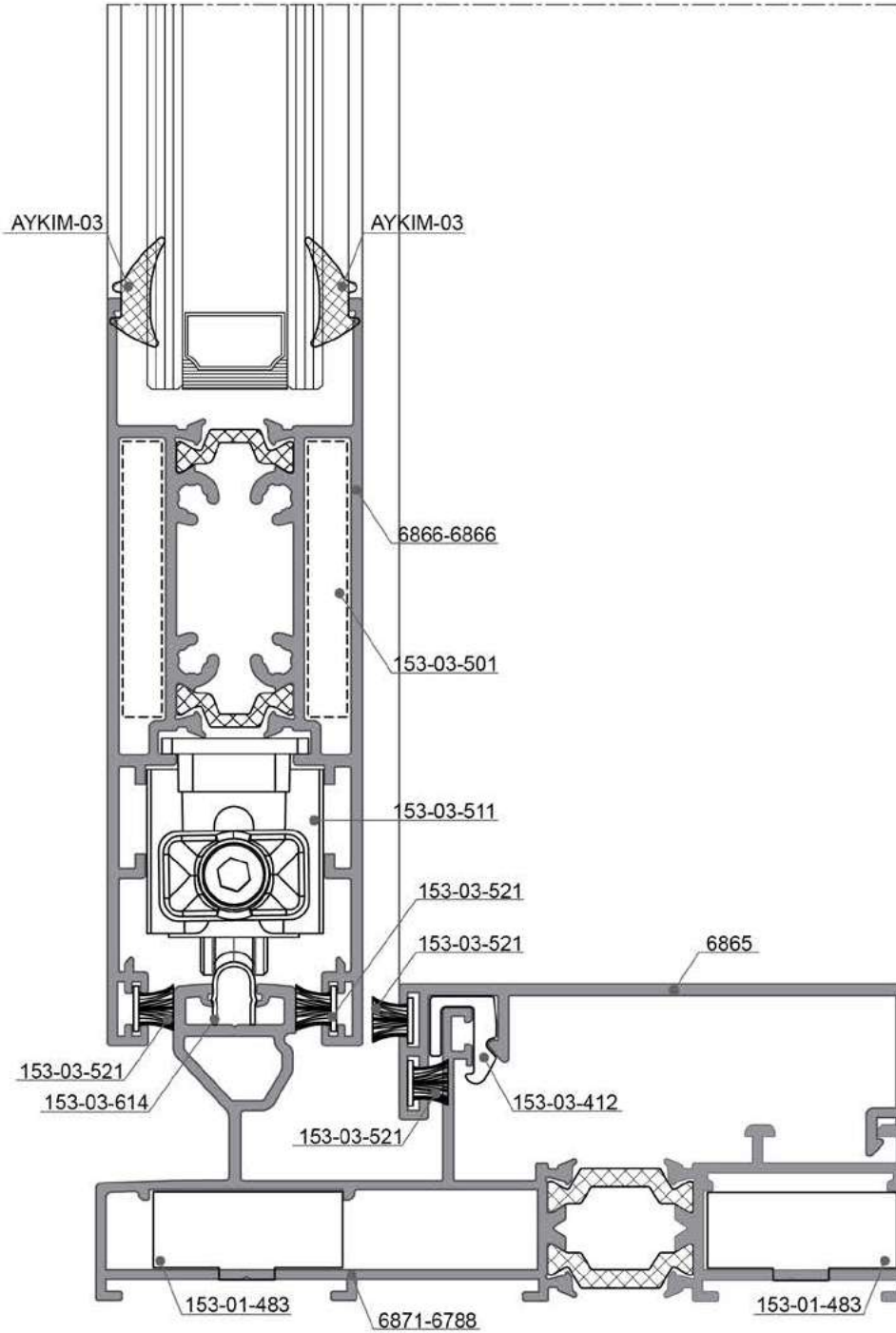
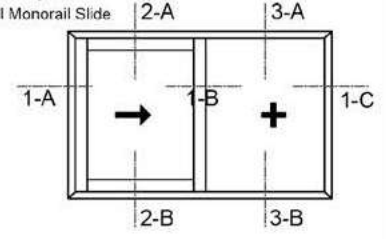
90° Klasik Tek Ray Sürme
90° Classical Monorail Slide2-B
DETAYI
DETAIL

Ölçek: 1:1 / Scale: 1:1

90° Klasik Tek Ray Sürme

90° Classical Monorail Slide

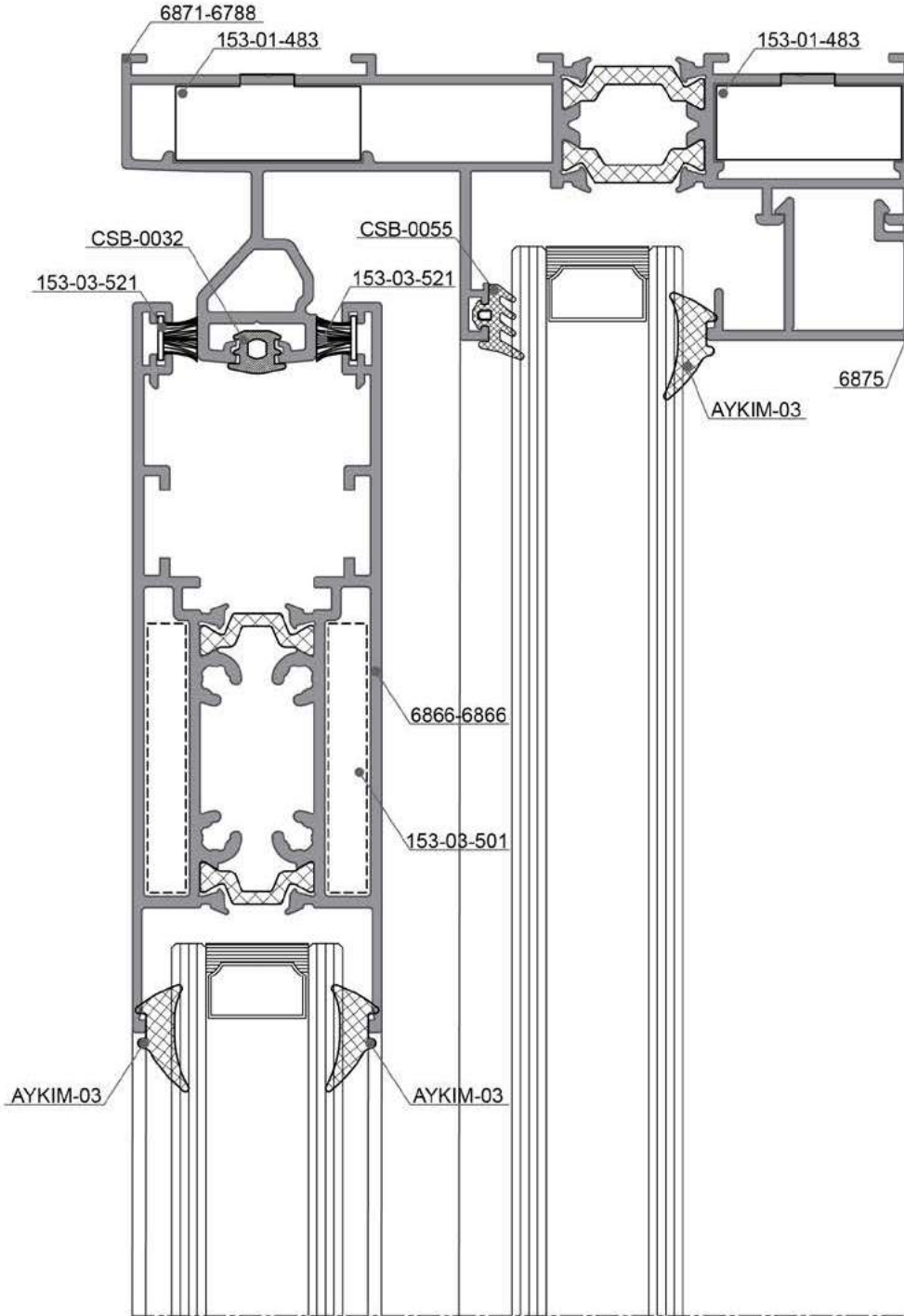
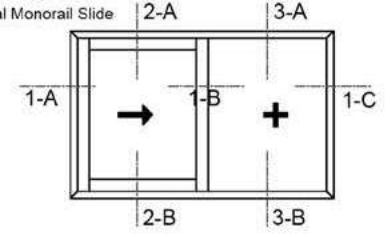
 3-A DETAYI
 DETAIL

Ölçek: 1:1 / Scale: 1:1

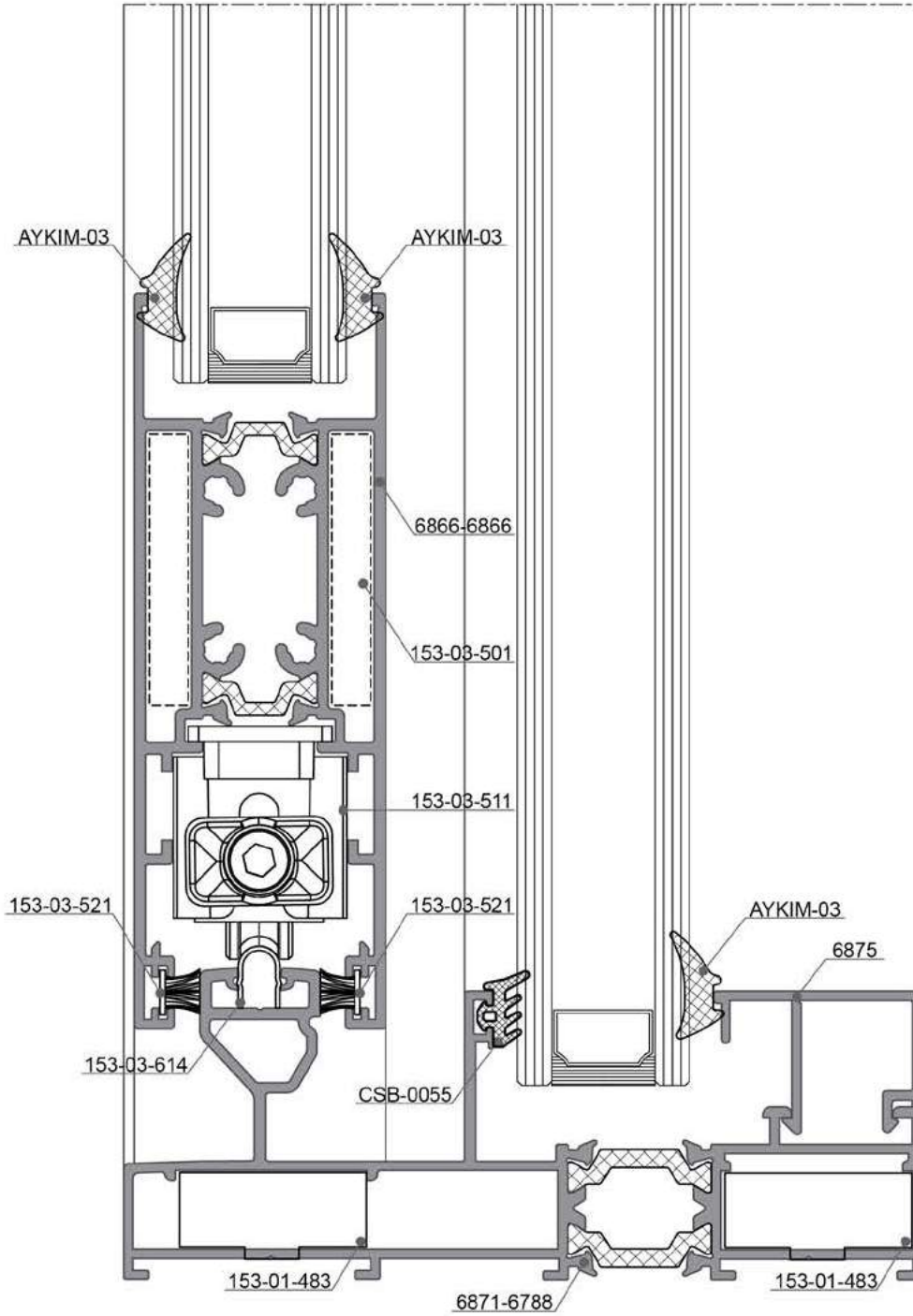
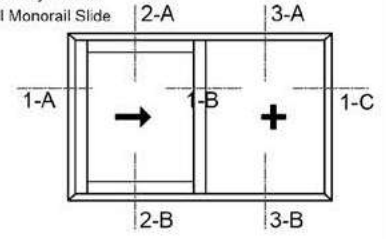
90° Klasik Tek Ray Sürme
90° Classical Monorail Slide3-B
DETAYI
DETAIL

Ölçek: 1:1 / Scale: 1:1

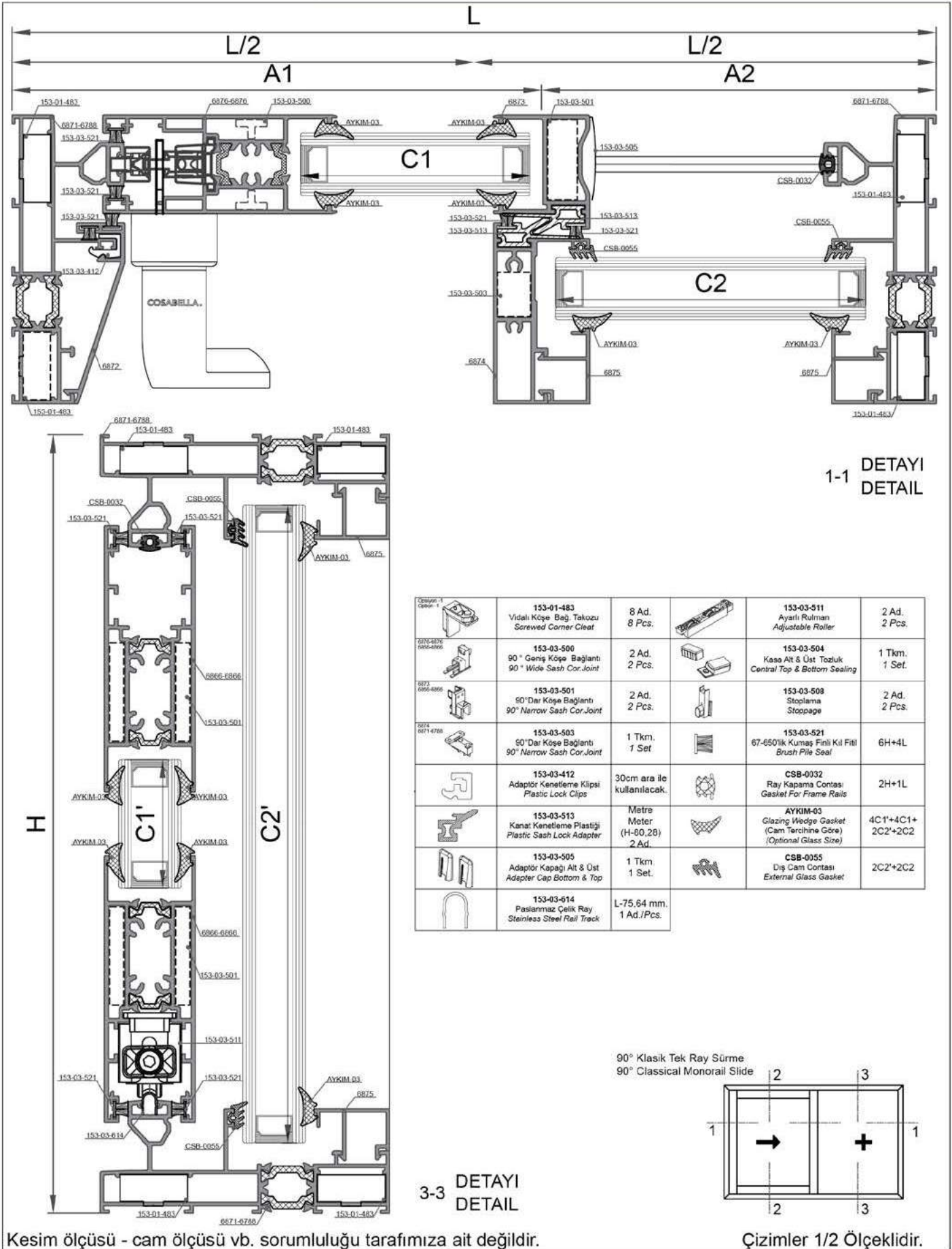

Kesim ölçüsü - cam ölçüsü vb. sorumluluğu tarafımıza ait değildir.

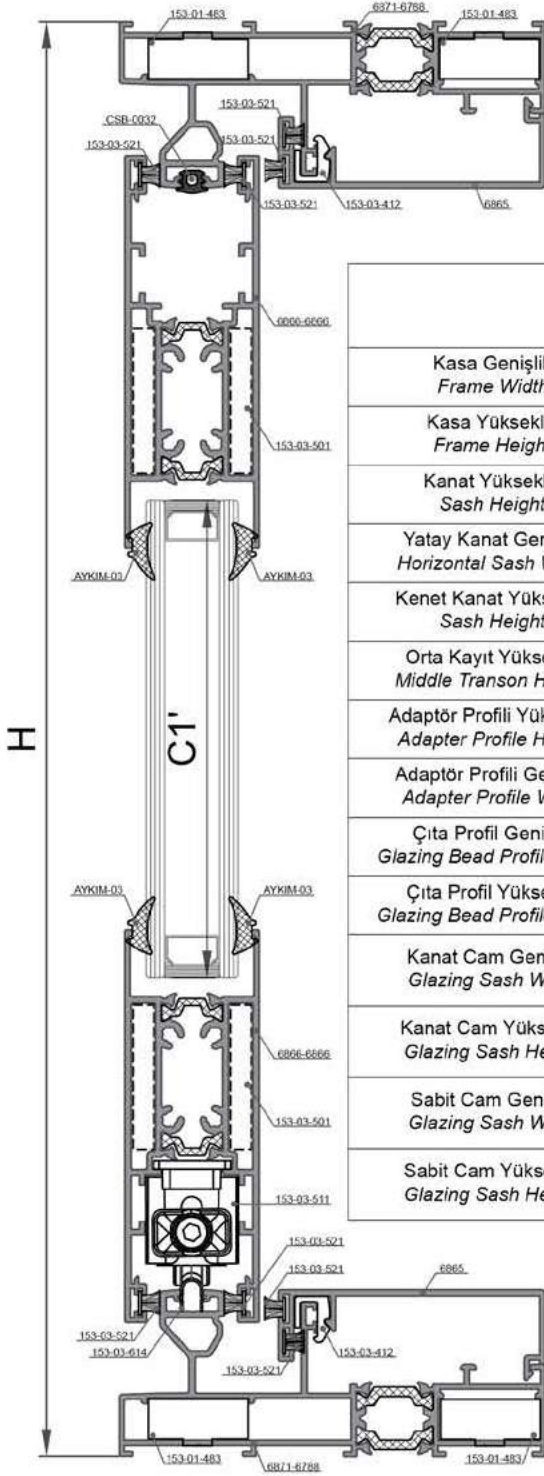

Kasa Genişlik Frame Width	6871-6788			2 Ad. 2 Pcs.	L
Kasa Yükseklik Frame Height	6871-6788			2 Ad. 2 Pcs.	H
Kanat Yükseklik Sash Height	6876-6876			1 Ad. 1 Pcs.	H-76
Yatay Kanat Genişlik Horizontal Sash Width	6866-6866			2 Ad. 2 Pcs.	A1-139,41
Kenet Kanat Yükseklik Sash Height	6873			1 Ad. 1 Pcs.	H-76
Orta Kayıt Yükseklik Middle Transon Height	6874			1 Ad. 1 Pcs.	H-80,46
Adaptör Profili Yükseklik Adapter Profile Height	6872			1 Ad. 1 Pcs.	H-87
Adaptör Profili Genişlik Adapter Profile Width	6865			2 Ad. 2 Pcs.	A1-42,51
Çıta Profil Genişlik Glazing Bead Profile Width	6875			2 Ad. 2 Pcs.	A2-26,39
Çıta Profil Yükseklik Glazing Bead Profile Height	6875			2 Ad. 2 Pcs.	H-80,46
Kanat Cam Genişlik Glazing Sash Width				1 Ad. 1 Pcs.	A1-115,42
Kanat Cam Yükseklik Glazing Sash Height				1 Ad. 1 Pcs.	H-250
Sabit Cam Genişlik Glazing Sash Width				1 Ad. 1 Pcs.	A2-32,4
Sabit Cam Yükseklik Glazing Sash Height				1 Ad. 1 Pcs.	H-54,2

2-2 DETAYI
DETAIL

Kesim ölçüsü - cam ölçüsü vb. sorumluluğu tarafımıza ait değildir.

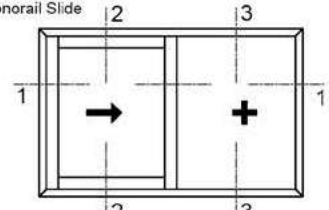



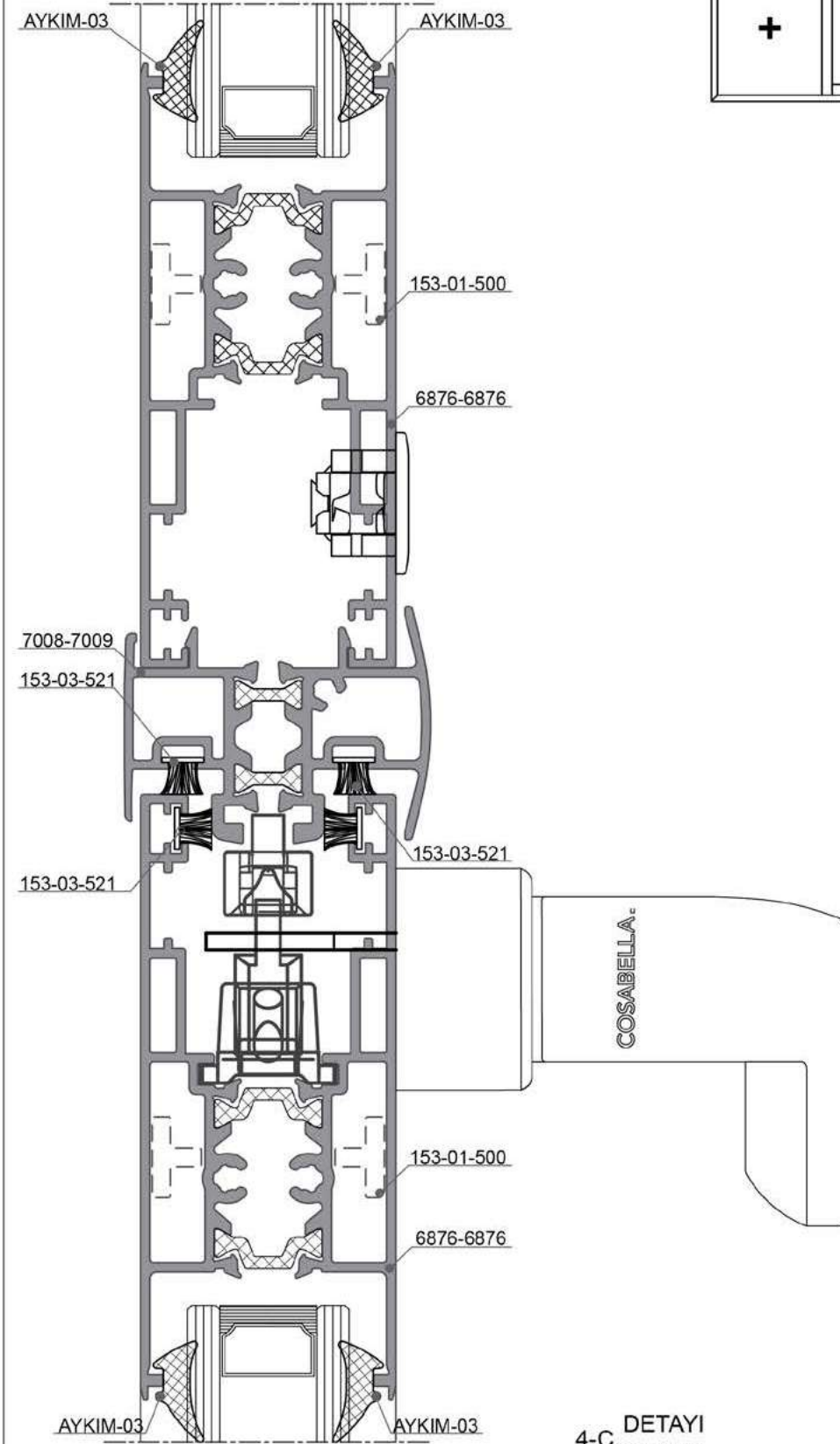
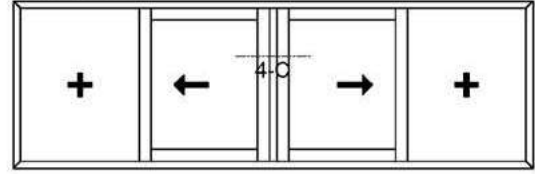



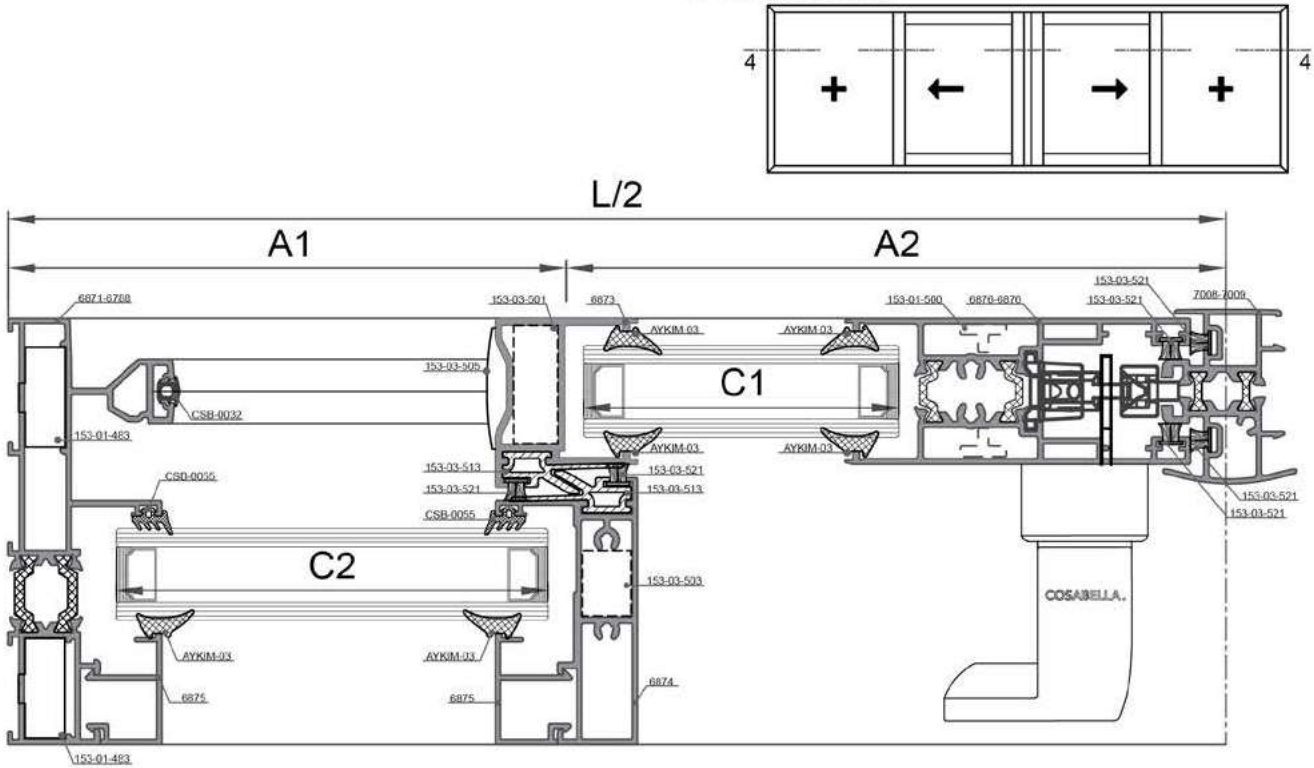

















90° Klasik Tek Ray Sürme
90° Classical Monorail Slide

Çizimler 1/2 Ölçeklidir.

90° Klasik Tek Ray Sürme
 90° Classical Monorail Slide

 4-C DETAYI
 DETAIL

Ölçek: 1:1 / Scale: 1:1

90° Klasik Tek Ray Sürme
90° Classical Monorail Slide

					
Kasa Genişlik Frame Width	6871-6788			2 Ad. 2 Pcs.	L
Kasa Yükseklik Frame Height	6871-6788			2 Ad. 2 Pcs.	H
Yatay Kanat Genişlik Horizontal Sash Width	6866-6866			4 Ad. 4 Pcs.	A2-113,9
Kanat Yükseklik Sash Height	6876-6876			2 Ad. 2 Pcs.	H-76
Kenet Kanat Yükseklik Sash Height	6873			2 Ad. 2 Pcs.	H-76
Kenet Kanat Yükseklik Sash Height	6874			2 Ad. 2 Pcs.	H-76
Adaptör Profil Yükseklik Adapter Profile Height	7008-7009			1 Ad. 1 Pcs.	H-106
Çıta Profil Genişlik - Yükseklik Glazing Bead Pr. Width - Height	6875			4 Ad. 4 Pcs.	A1-26,47 H-80,46
Kanat Cam Genişlik Glazing Sash Width				2 Ad. 2 Pcs.	A2-90
Kanat Cam Yükseklik Glazing Sash Height				2 Ad. 2 Pcs.	H-250
Sabit Cam Genişlik Glazing Sash Height				2 Ad. 2 Pcs.	A1-33
Sabit Cam Yükseklik Glazing Sash Height				2 Ad. 2 Pcs.	H-54,2

Kesim ölçüsü - cam ölçüsü vb. sorumluluğu tarafımıza ait değildir.

Çizimler 1/2 Ölçeklidir.

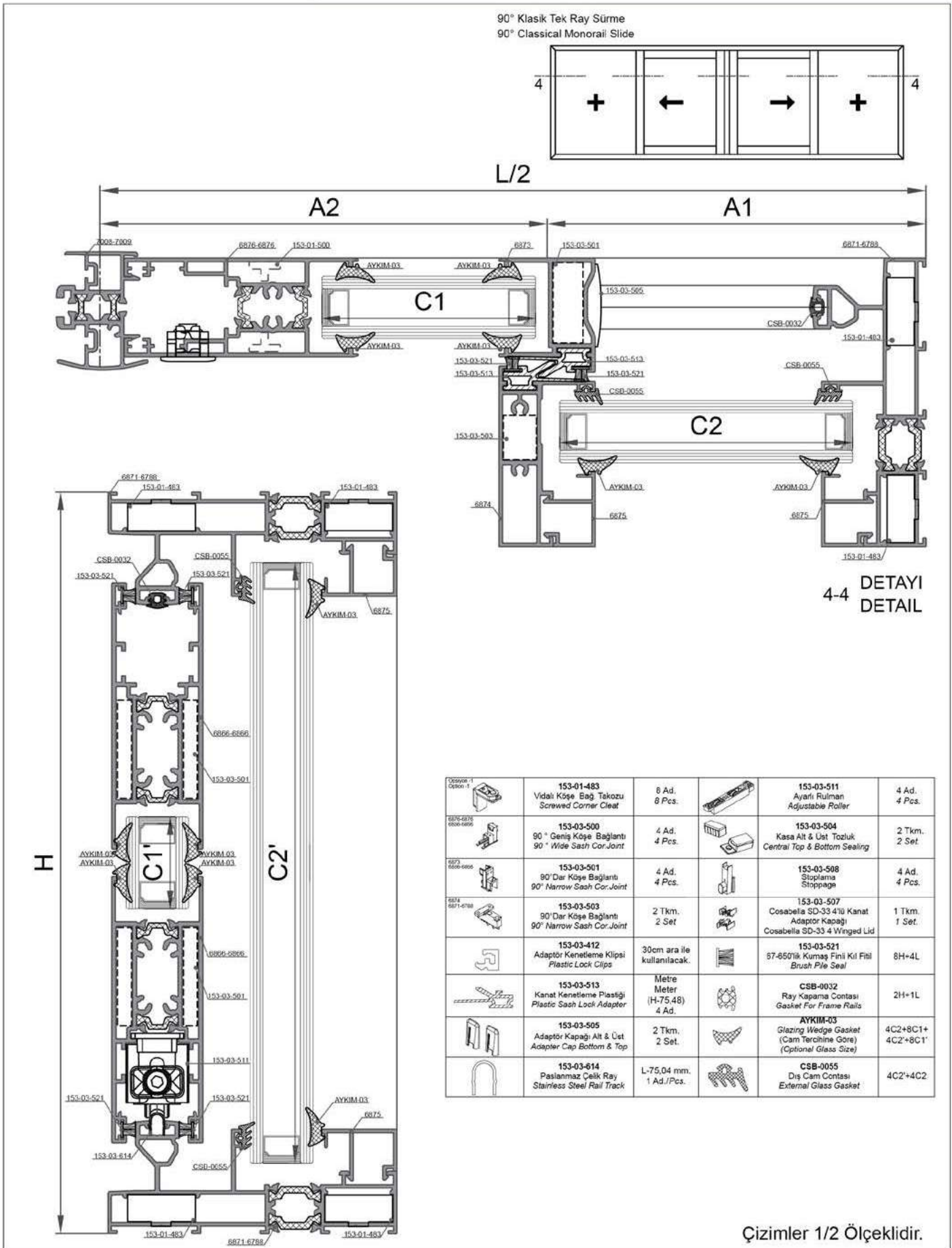

90° Klasik Sürme
90° Classical Slide

6-A

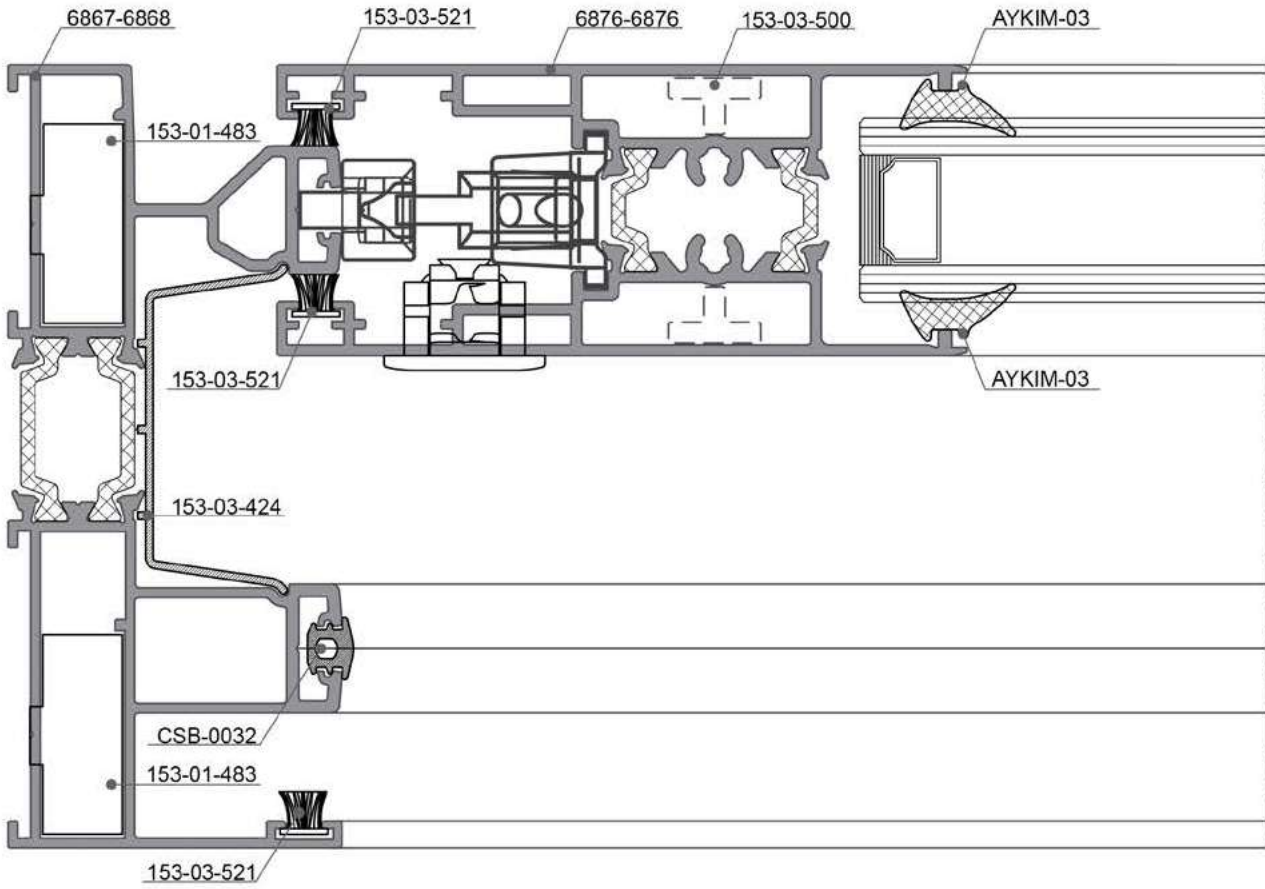
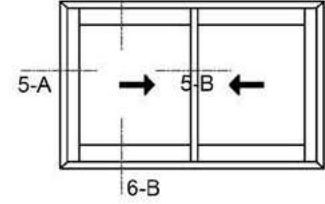
5-A
DETAYI
DETAIL

Ölçek: 1:1 / Scale: 1:1

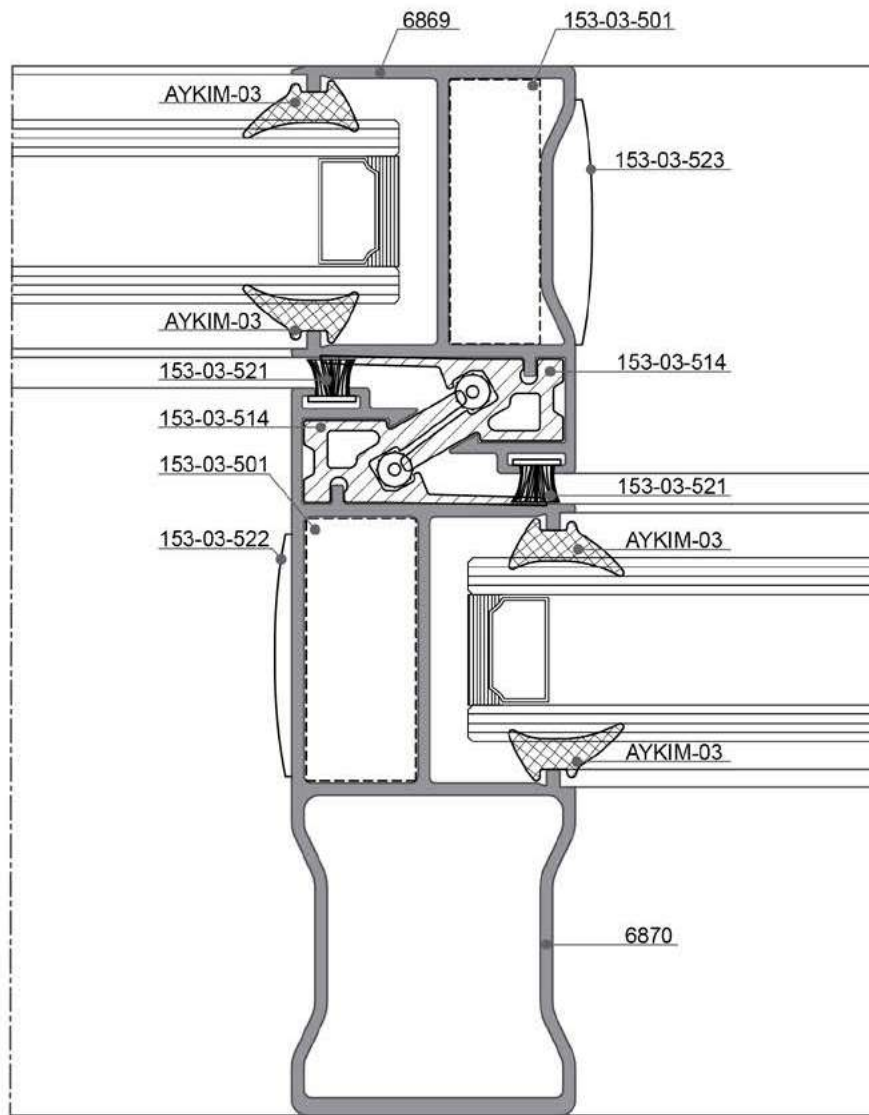
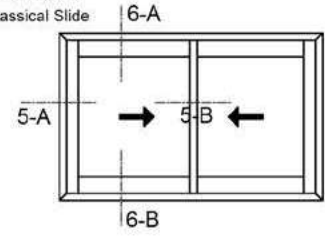
90° Klasik Sürme
 90° Classical Slide

 5-B DETAYI
 DETAIL

Ölçek: 1:1 / Scale: 1:1

90° Klasik Sürme
 90° Classical Slide

6-A

5-A

5-B

6-B

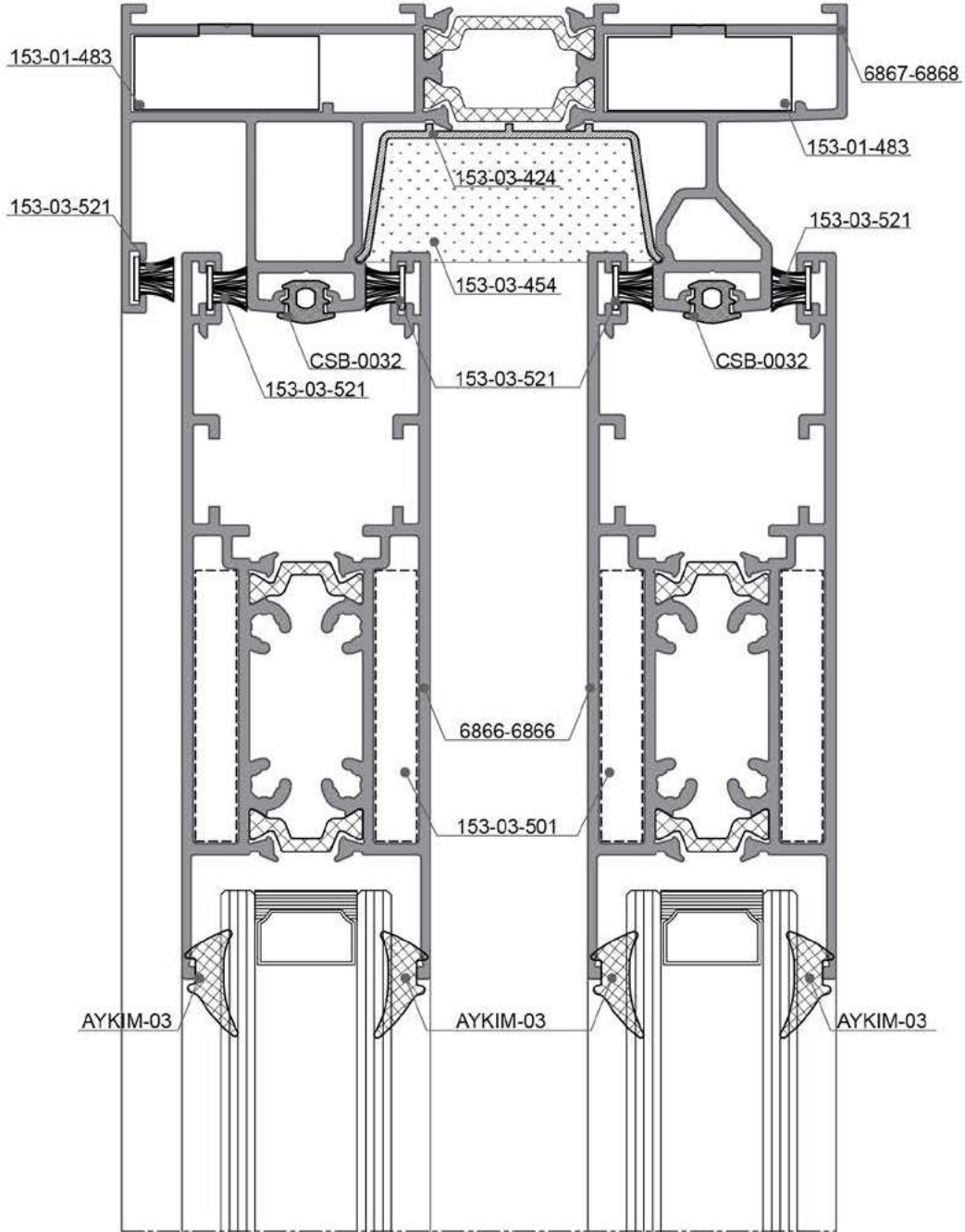
 6-A
 DETAYI
 DETAIL

Ölçek: 1:1 / Scale: 1:1

90° Klasik Sürme
 90° Classical Slide

6-A

5-A

5-B

6-B

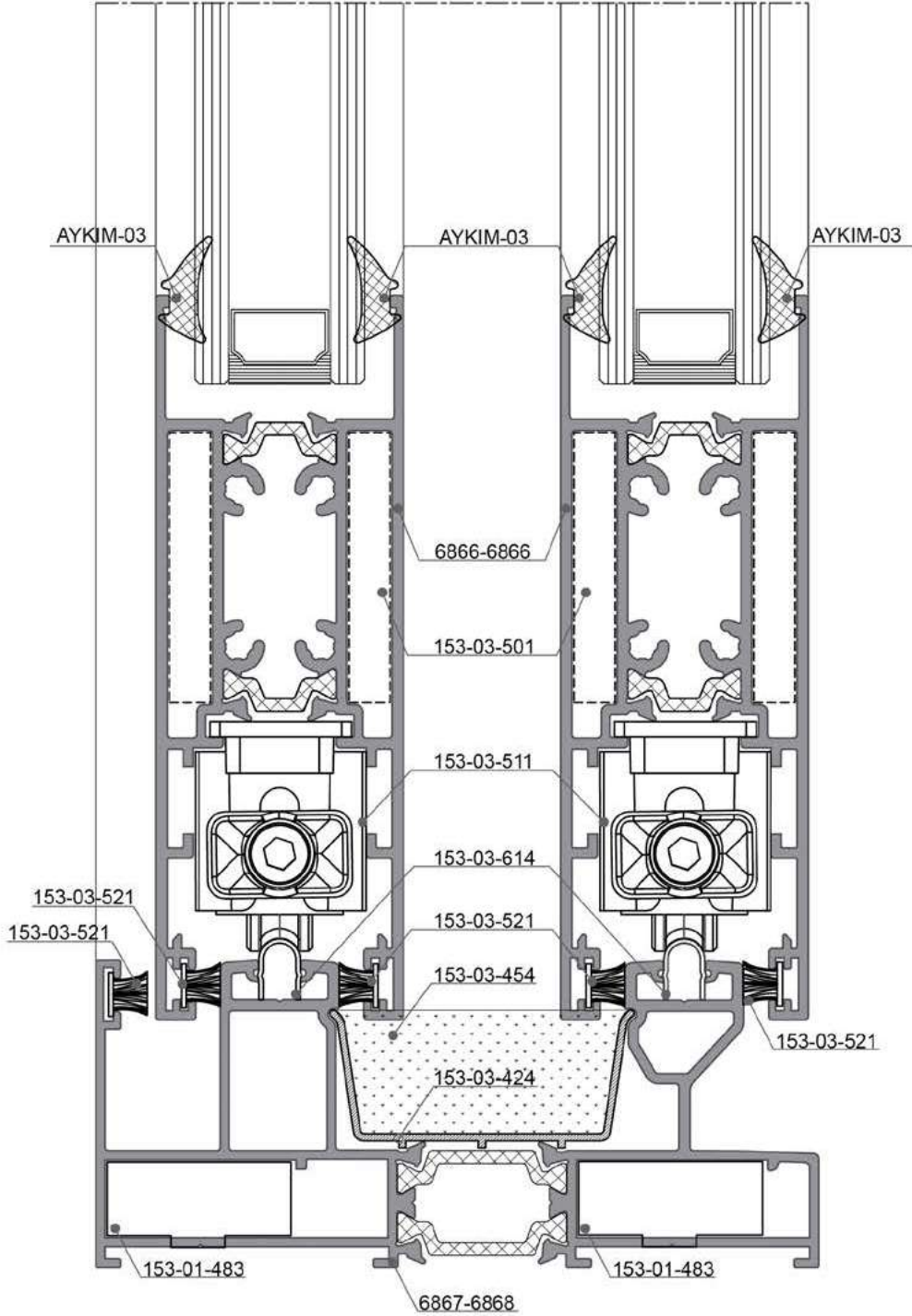

 6-B DETAYI
 DETAIL

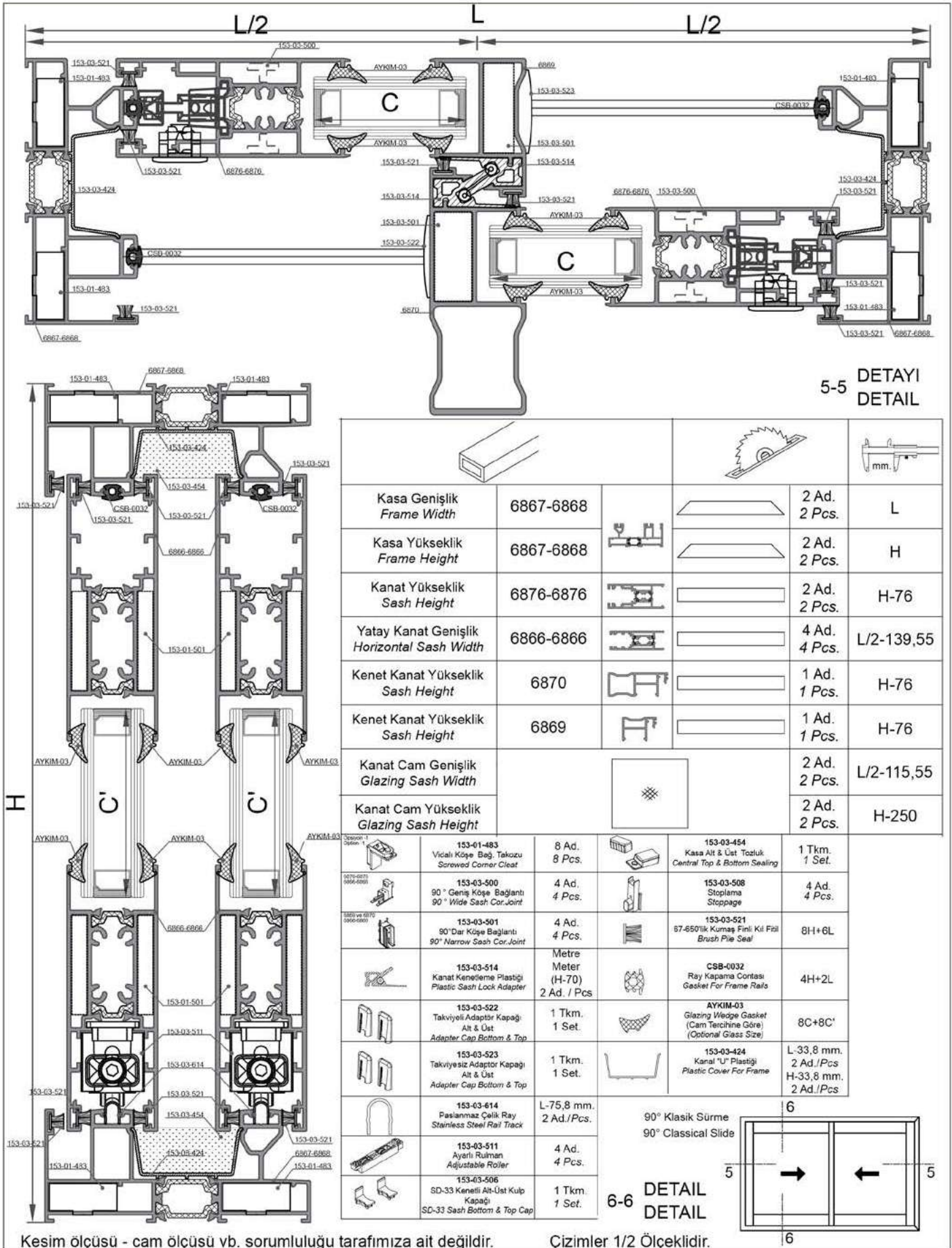

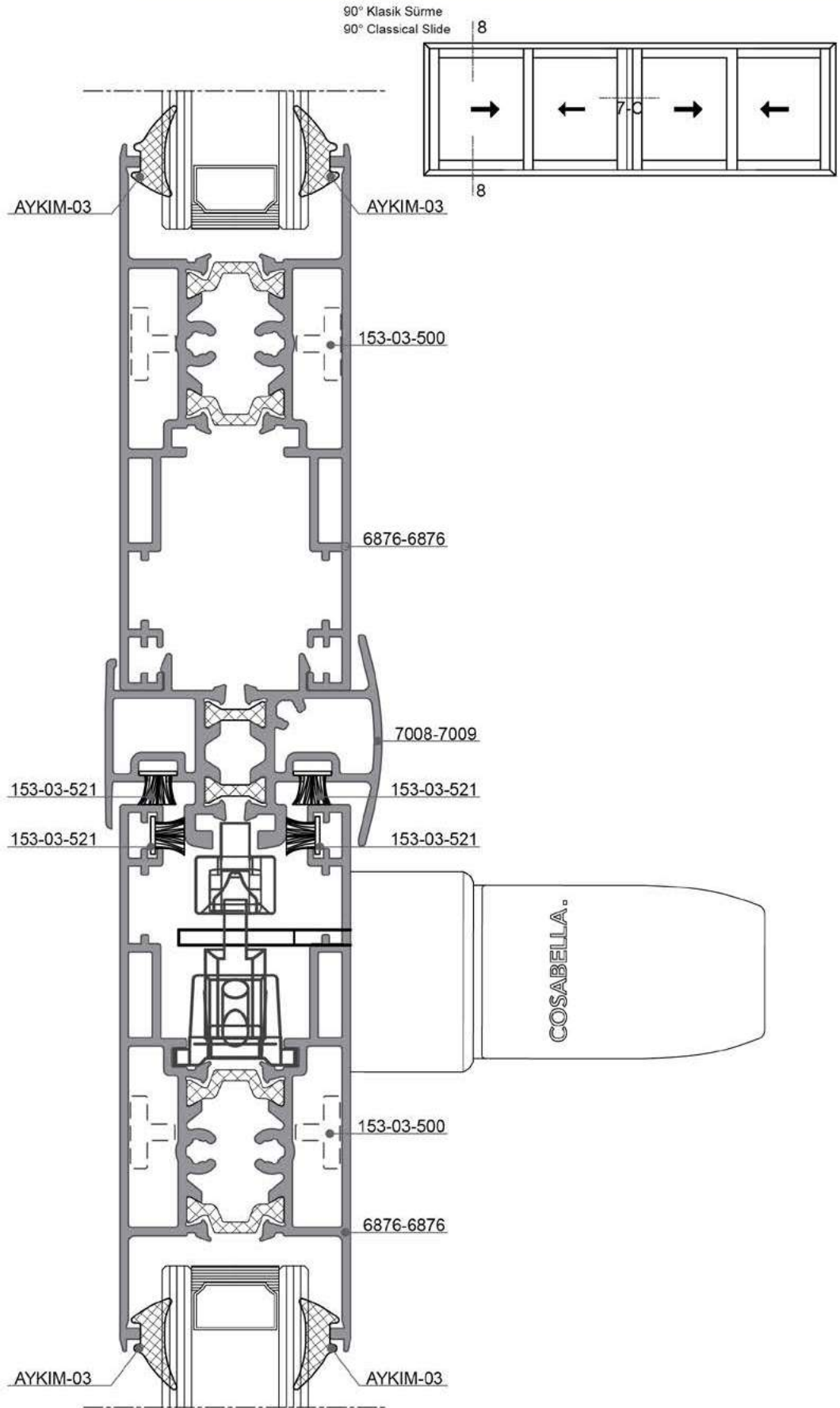



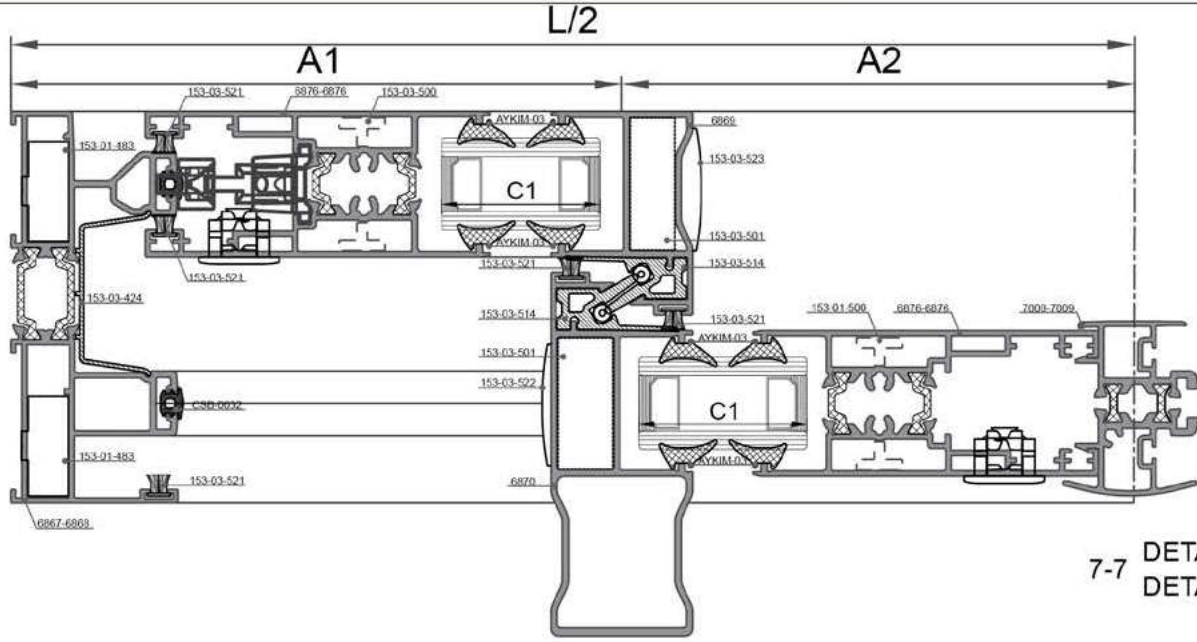

Ölçek: 1:1 / Scale: 1:1

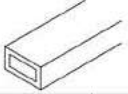
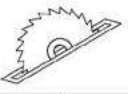
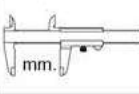



 7-C
 DETAYI
 DETAIL

Ölçek: 1:1 / Scale: 1:1

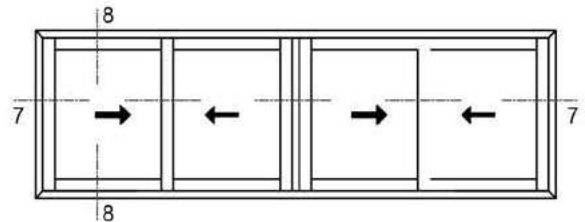

			
Kasa Genişlik Frame Width	6871-6788		2 Ad. 2 Pcs. L
Kasa Yükseklik Frame Height	6871-6788		2 Ad. 2 Pcs. H
Kanat Yükseklik Sash Height	6876-6876		4 Ad. 4 Pcs. H-76
Yatay Kanat Genişlik Horizontal Sash Width	6866-6866		8 Ad. 8 Pcs. A1-139,5
Kenet Kanat Yükseklik Sash Height	6869		2 Ad. 2 Pcs. H-76
Kenet Kanat Yükseklik Sash Height	6870		2 Ad. 2 Pcs. H-76
Adaptör Profil Yükseklik Adapter Profile Height	7008-7009		1 Ad. 1 Pcs. H-106
Kanat Cam Genişlik Glazing Sash Width			4 Ad. 4 Pcs. A1-115,5
Kanat Cam Yükseklik Glazing Sash Height			4 Ad. 4 Pcs. H-250



Kesim ölçüsü - cam ölçüsü vb. sorumluluğu tarafımıza ait değildir.

Ölçek: 1:2 / Scale: 1:2

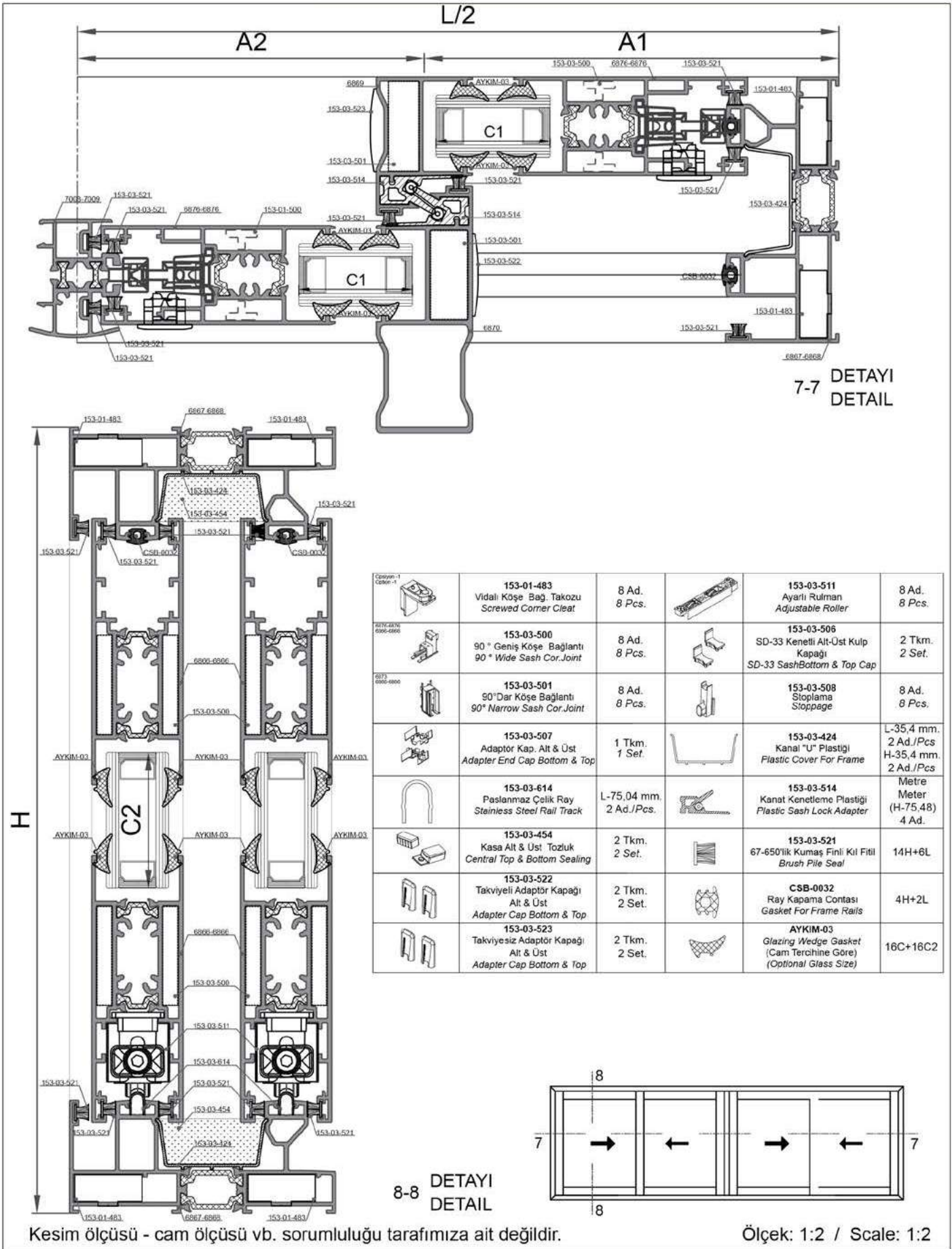

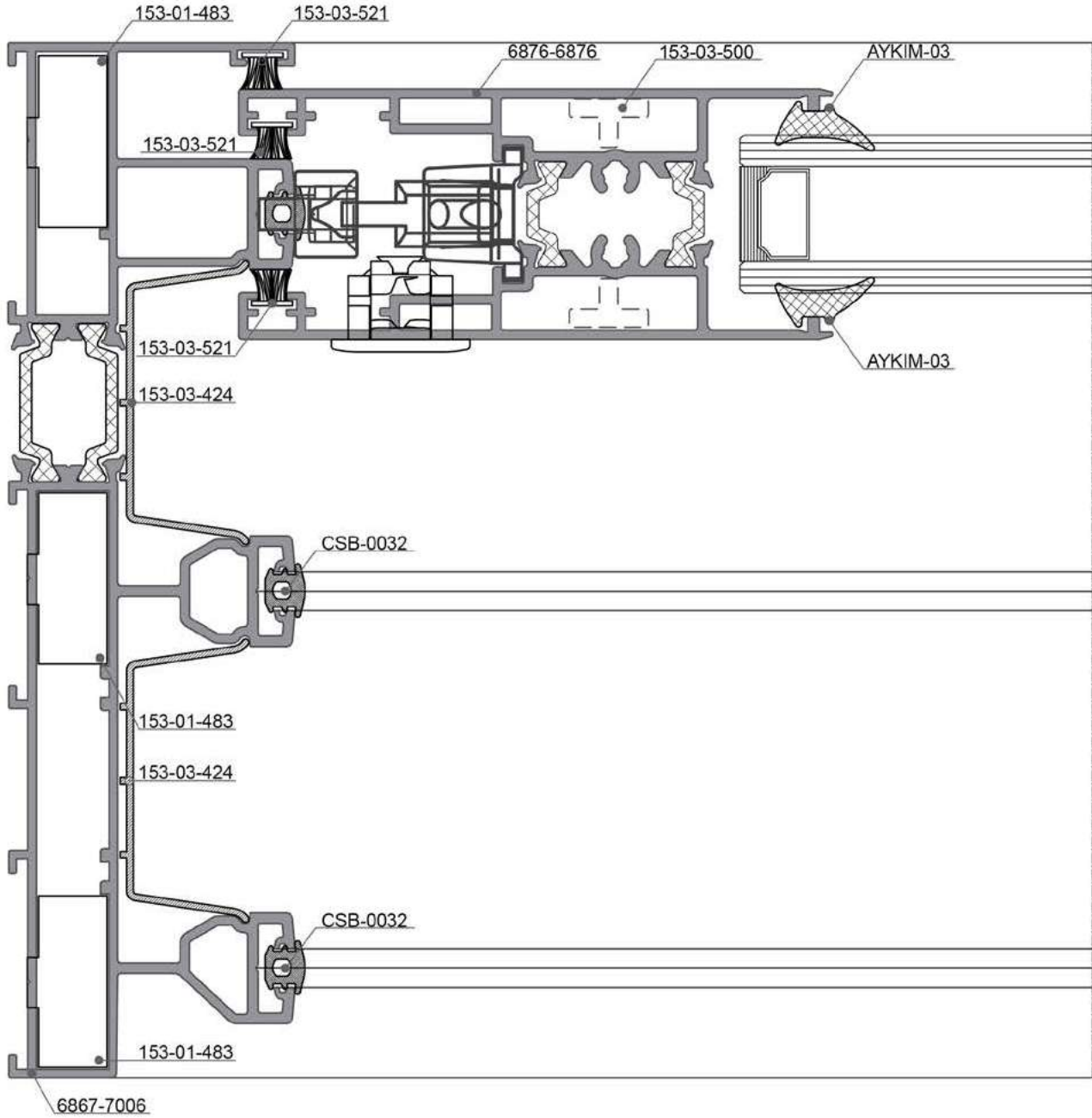
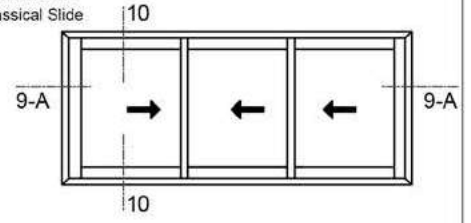
90° Klasik Sürme
90° Classical Slide9-A DETAYI
DETAIL

Ölçek: 1:1 / Scale: 1:1

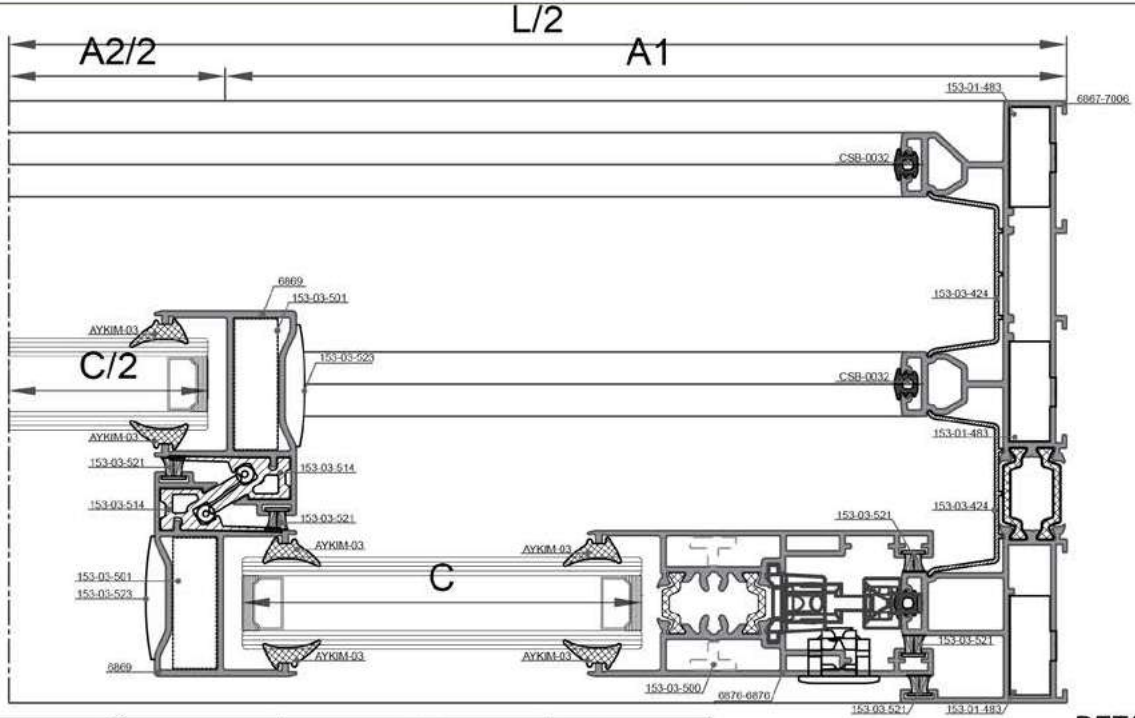
9-9 DETAYI
DETAIL

Kasa Genişlik Frame Width	6867-7006			2 Ad. 2 Pcs.	L
Kasa Yükseklik Frame Height	6867-7006			2 Ad. 2 Pcs.	H
Kanat Yükseklik Sash Height	6876-6876			2 Ad. 2 Pcs.	H-76
Yatay Kanat Genişlik Horizontal Sash Width	6866-6866			6 Ad. 6 Pcs.	A1-139,5
Kenet Kanat Yükseklik Sash Height	6870			1 Ad. 1 Pcs.	H-76
Kenet Kanat Yükseklik Sash Height	6869			3 Ad. 3 Pcs.	H-76
Destek Pr. Genişlik Support Pr. Width	6912			1 Ad. 1 Pcs.	L
Kanat Cam Genişlik Glazing Sash Width				3 Ad. 3 Pcs.	A1-115,5
Kanat Cam Yükseklik Glazing Sash Height				3 Ad. 3 Pcs.	H-250

	153-01-483 Vidalı Köşe Bağ. Takozu Screwed Corner Cleat	8 Ad. 8 Pcs.		153-03-506 SD-33 Kenetli Alt-Üst Kulp Kapağı SD-33 Sash Bottom & Top Cap	1 Tkm. 1 Set.
	153-03-500 90° Geniş Köşe Bağlantı 90° Wide Sash Cor Joint	4 Ad. 4 Pcs.		153-03-424 Kanal 'U' Plastik Kapağı Plastic Cover For Frame	L-35,4 mm. 2 Ad./Pcs H-35,4 mm. 2 Ad./Pcs
	153-03-501 90° Dar Köşe Bağlantı 90° Narrow Sash Cor Joint	8 Ad. 8 Pcs.		153-03-454 Kasa Alt & Üst Tuzluk Central Top & Bottom Sealing	2 Tkm 2 Set.
	153-03-522 Takviyeli Adaptör Kapağı Alt & Üst Adapter Cap Bottom & Top	2 Tkm. 2 Set.		153-03-514 Kanat Kenetleme Plastik Kapağı Plastic Sash Lock Adapter	Metre Meter (H-75,48) 4 Ad.
	153-03-523 Takviyesiz Adaptör Kapağı Alt & Üst Adapter Cap Bottom & Top	2 Tkm. 2 Set.		153-03-521 67-650'lik Kummaç Finitli Kıl Fali Brush Pile Seal	10H+8L
	153-03-614 Paslanmaz Çelik Ray Stainless Steel Rail Track	L-75,48 mm. 3 Ad./Pcs.		CSB-0032 Ray Kapama Contası Gasket For Frame Rails	6H+3L
	153-03-511 Ayarlı Rulman Adjustable Roller	6 Ad. 6 Pcs.		AYKIM-03 Glazing Wedge Gasket (Cam Tercihine Göre) (Optional Glass Size)	12C+12C2

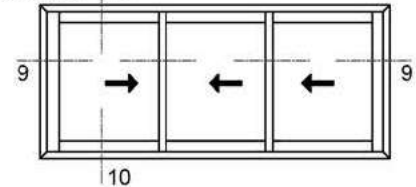
90° Klasik Sürme
90° Classical Slide | 10

Ölçek: 1:2 / Scale: 1:2

Kesim ölçüsü - cam ölçüsü vb. sorumluluğu tarafımıza ait değildir.

45° Klasik Sürme
 45° Classical Slide

12-A

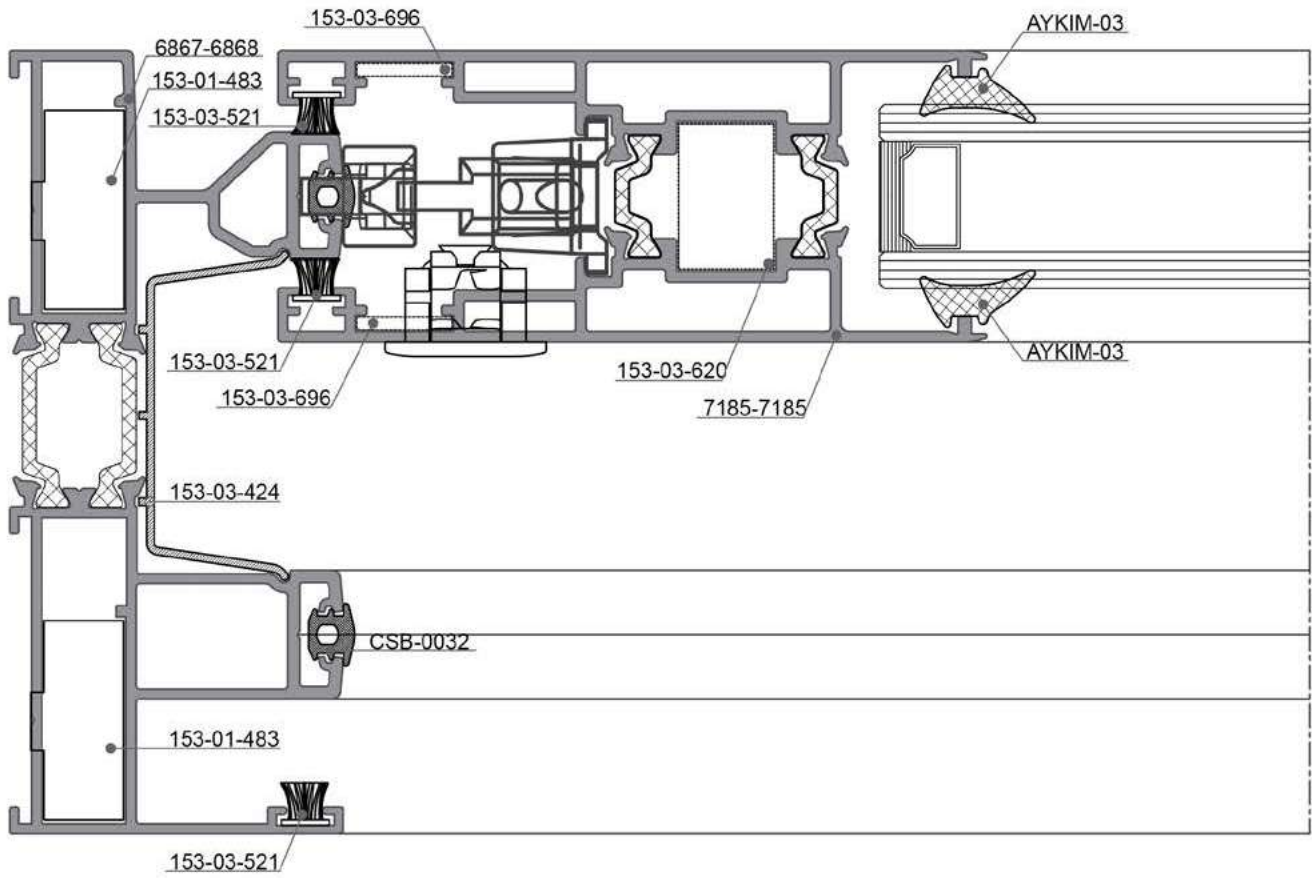
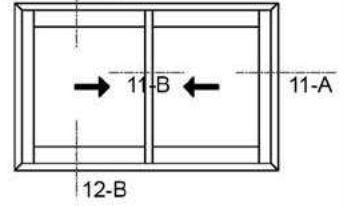
 11-A DETAYI
 DETAIL

Ölçek: 1:1 / Scale: 1:1

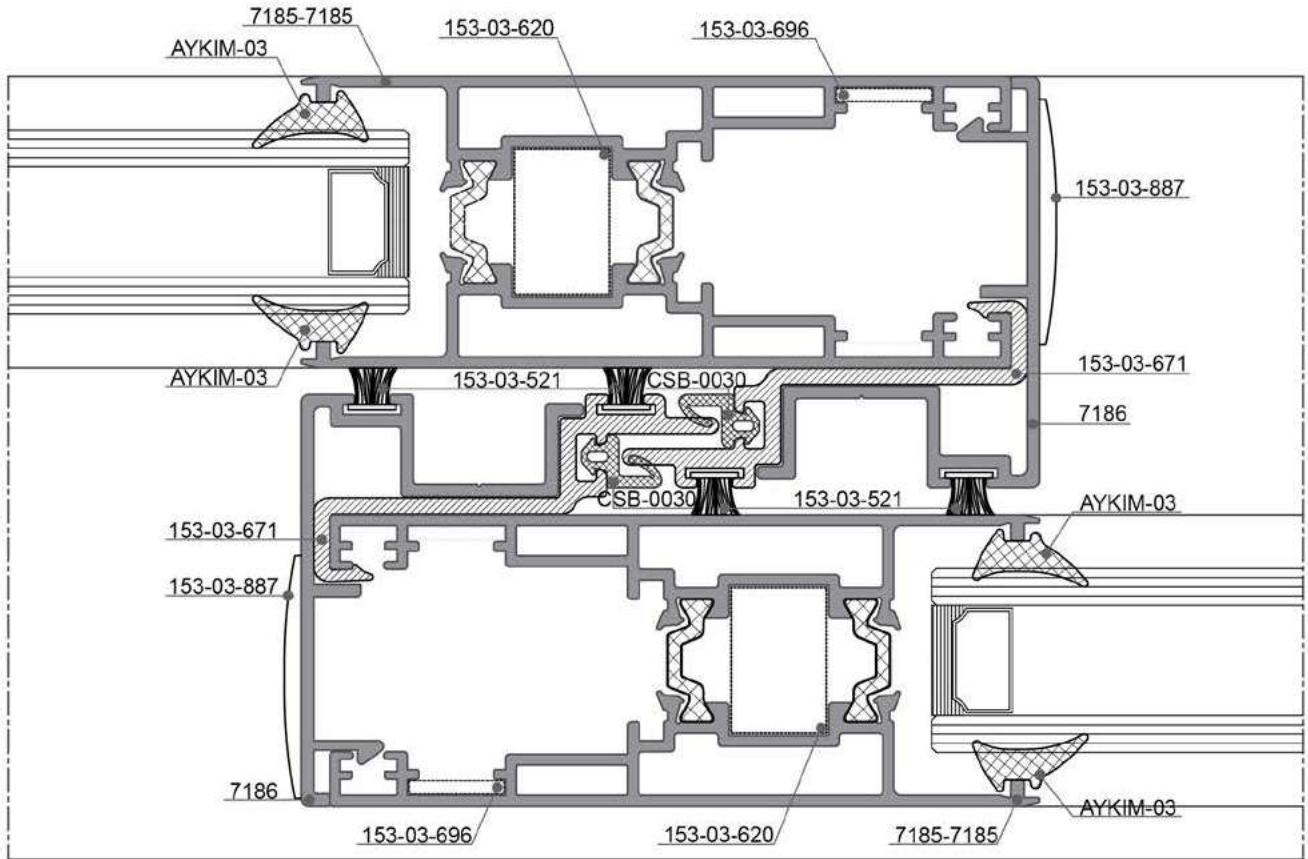
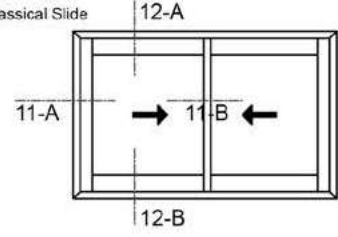
45° Klasik Sürme
45° Classical Slide11-B DETAYI
DETAIL

Ölçek: 1:1 / Scale: 1:1

45° Klasik Sürme
 45° Classical Slide

12-A

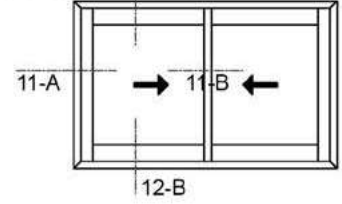

12-B

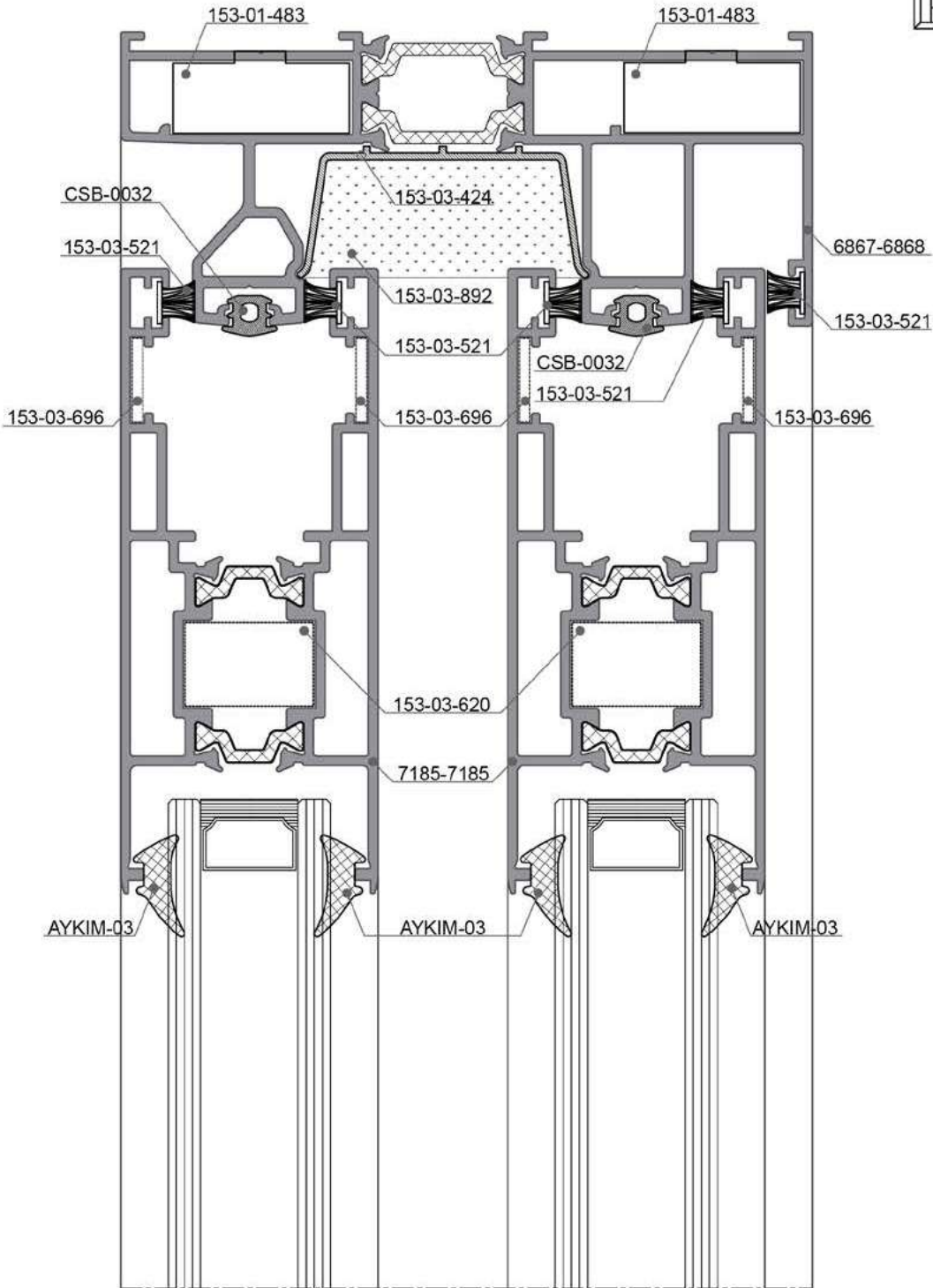
 12-A DETAYI
 DETAIL

Ölçek: 1:1 / Scale: 1:1

45° Klasik Sürme
45° Classical Slide

12-A

11-A

11-B

12-B

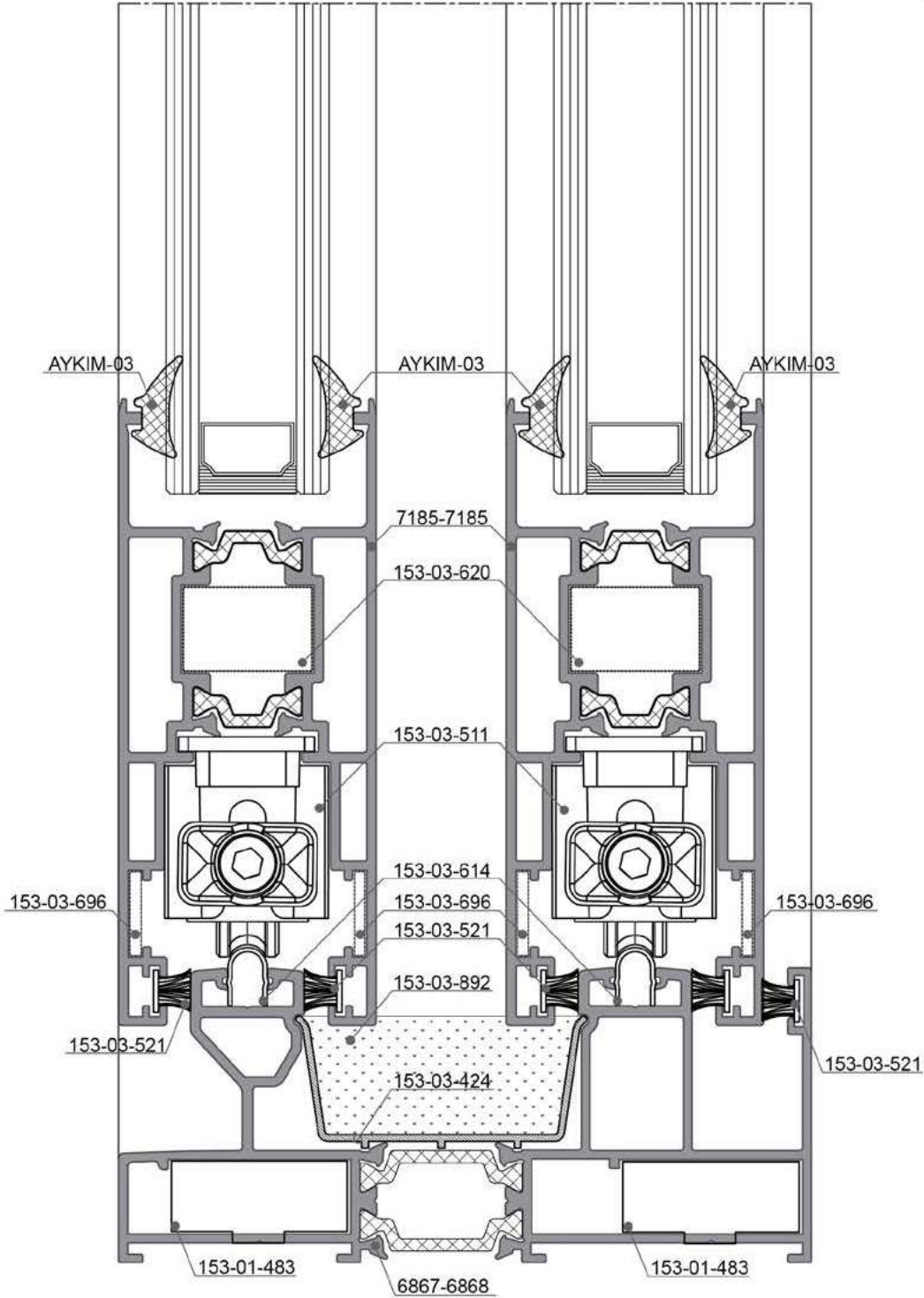
12-B DETAYI
DETAIL

Ölçek: 1:1 / Scale: 1:1

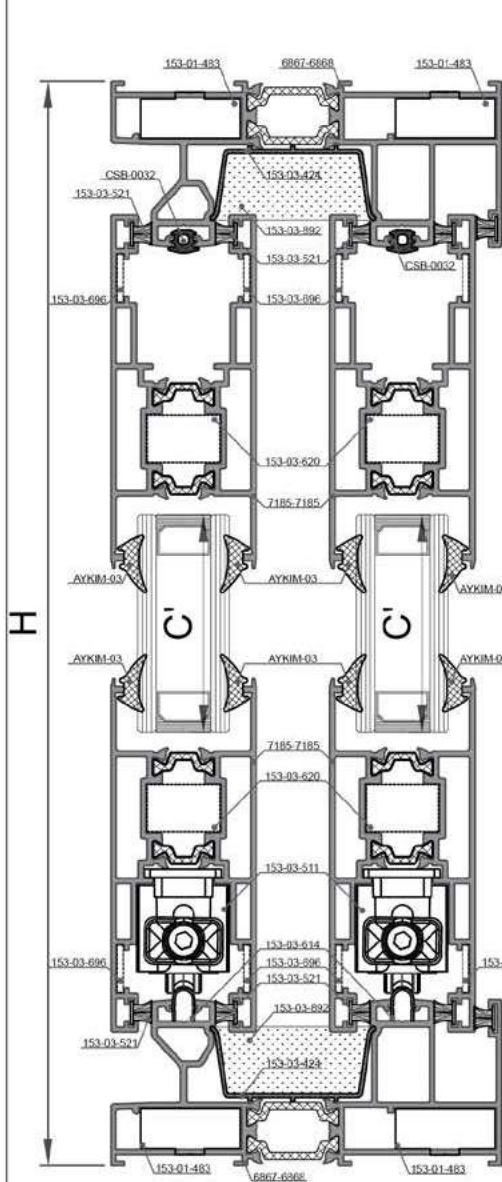
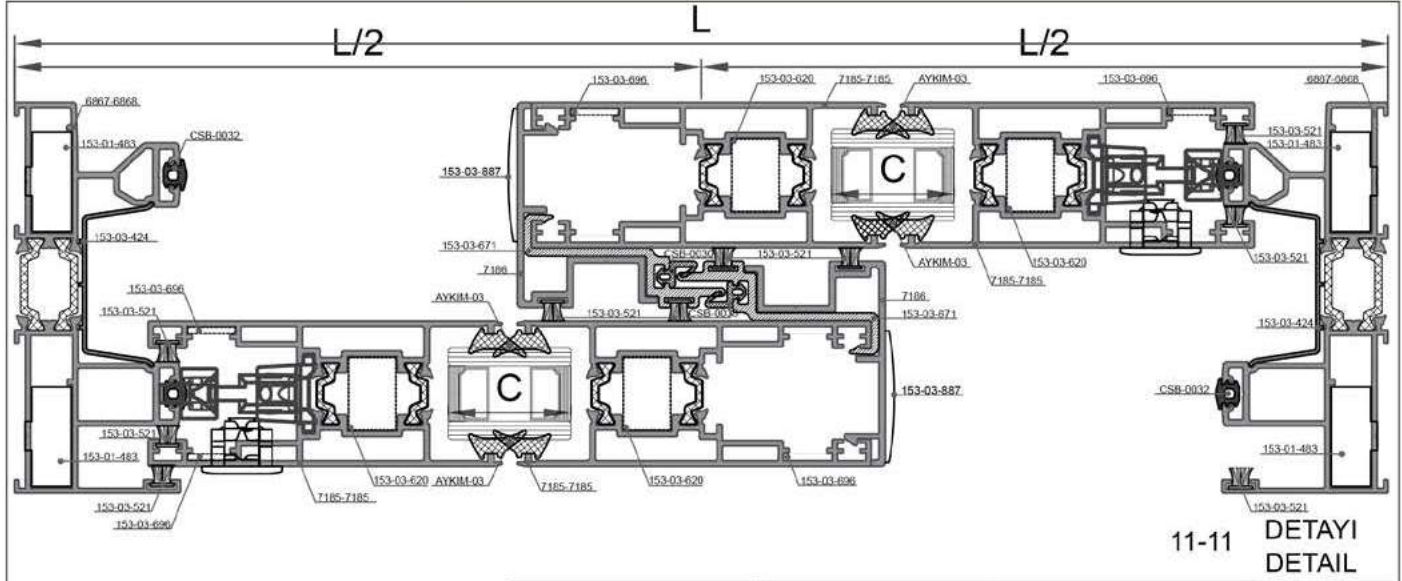

Kasa Genişlik Frame Width	6867-6868			2 Ad. 2 Pcs.	L
Kasa Yükseklik Frame Height	6867-6868			2 Ad. 2 Pcs.	H
Kanat Yükseklik Sash Height	7185-7185			4 Ad. 4 Pcs.	H-70
Kanat Genişlik Sash Width	7185-7185			4 Ad. 4 Pcs.	L/2+9,4
Kenet Kanat Yükseklik Sash Height	7186			2 Ad. 2 Pcs.	H-70
Kanat Cam Genişlik Glazing Sash Width				2 Ad. 2 Pcs.	L/2-147,6
Kanat Cam Yükseklik Glazing Sash Height				2 Ad. 2 Pcs.	H-227

	153-01-483 Vidalı Köşe Bağ Takozu Screwed Corner Cleat	8 Ad. 8 Pcs.		153-03-887 Adaptör Kapakçı Altı & Üst Adapter Cap Bottom & Top	2 Tkm. 2 Set.
	153-03-620 CSB Süme Seri 45° Köşe Takozu CSB Slide Series Screwed Corner Cleat	8 Ad. 8 Pcs.		153-03-889 Stoplama Stoppage	4 Ad. 4 Pcs.
	153-03-892 Kasa Alt & Üst Tozluk Central Top & Bottom Sealing	1 Tkm. 1 Set.		153-03-521 67-650'lük Kumuş Fırıl Kil Fırlı Brush Pile Seal	10H+4L
	153-03-671 Kanat Kenetleme Plastik Plastic Sash Lock Adapter	Metre Meter (H-75,48) 2 Ad. / Pcs		CSB-0032 Ray Kapama Contası Gasket For Frame Rails	4H+2L
	153-03-696 Kanat Köşe Gönye Alignment Square	16 Ad. 16 Pcs.		AYKIM-03 Glazing Wedge Gasket (Cam Terçimine Göre) (Optional Glass Size)	8C+8C'
	153-03-614 Paslanmaz Çelik Ray Stainless Steel Rail Track	L-75,48 mm. 2 Ad./Pcs.		CSB-0030 Cosabella Kenet Fırlı Cosabella Brush Pile Seal	2H
	153-03-511 Ayarlı Rulman Adjustable Roller	4 Ad. 4 Pcs.			12-A 11-A
	153-03-890 Sallantı Engelleme Shake Reducer	2 Ad. 2 Pcs.			
	153-03-424 Kanal "U" Plastik Plastic Cover For Frame	L-35,4 mm. 2 Ad./Pcs. H-35,4 mm. 2 Ad./Pcs.			

 12-12 DETAYI
 DETAIL





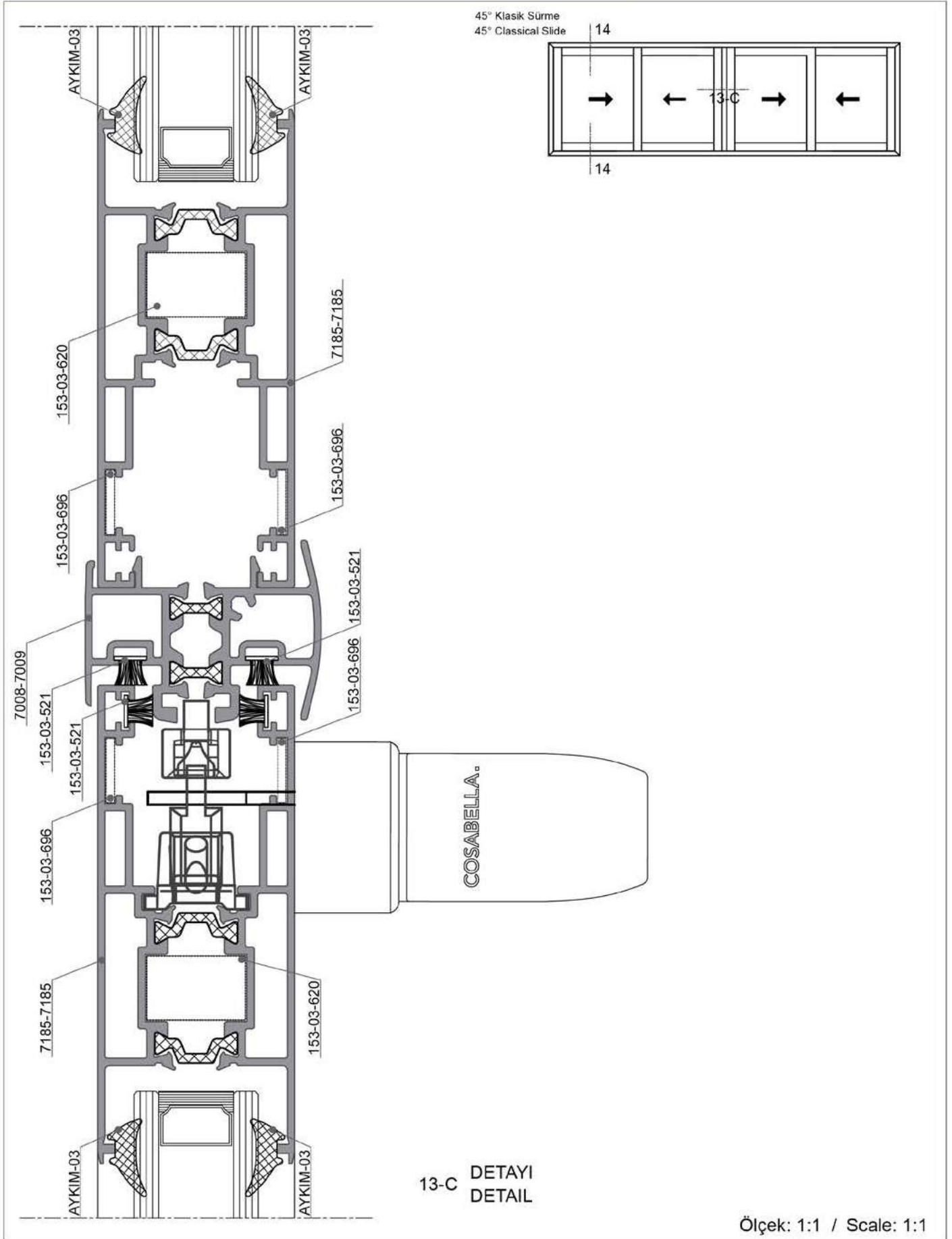

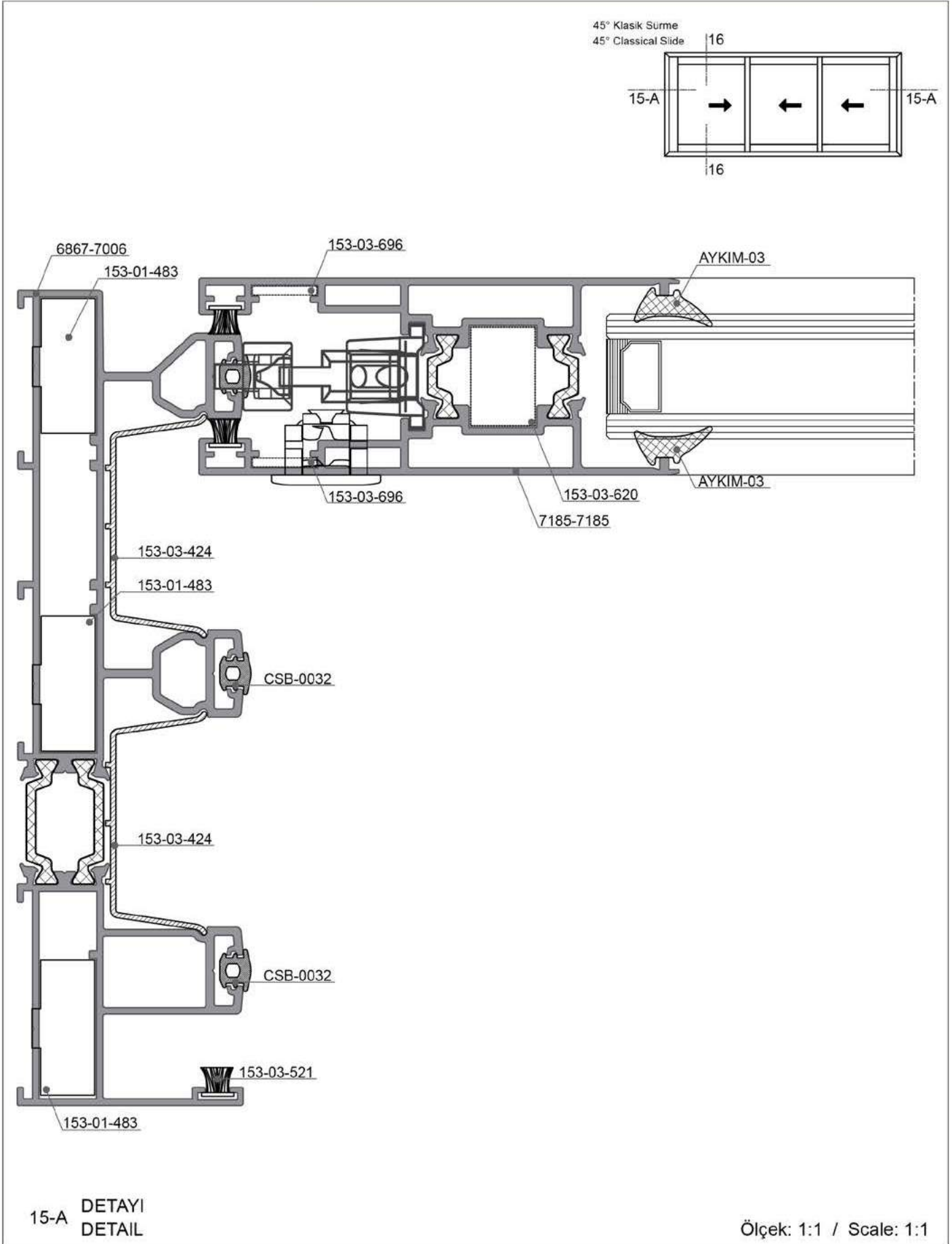

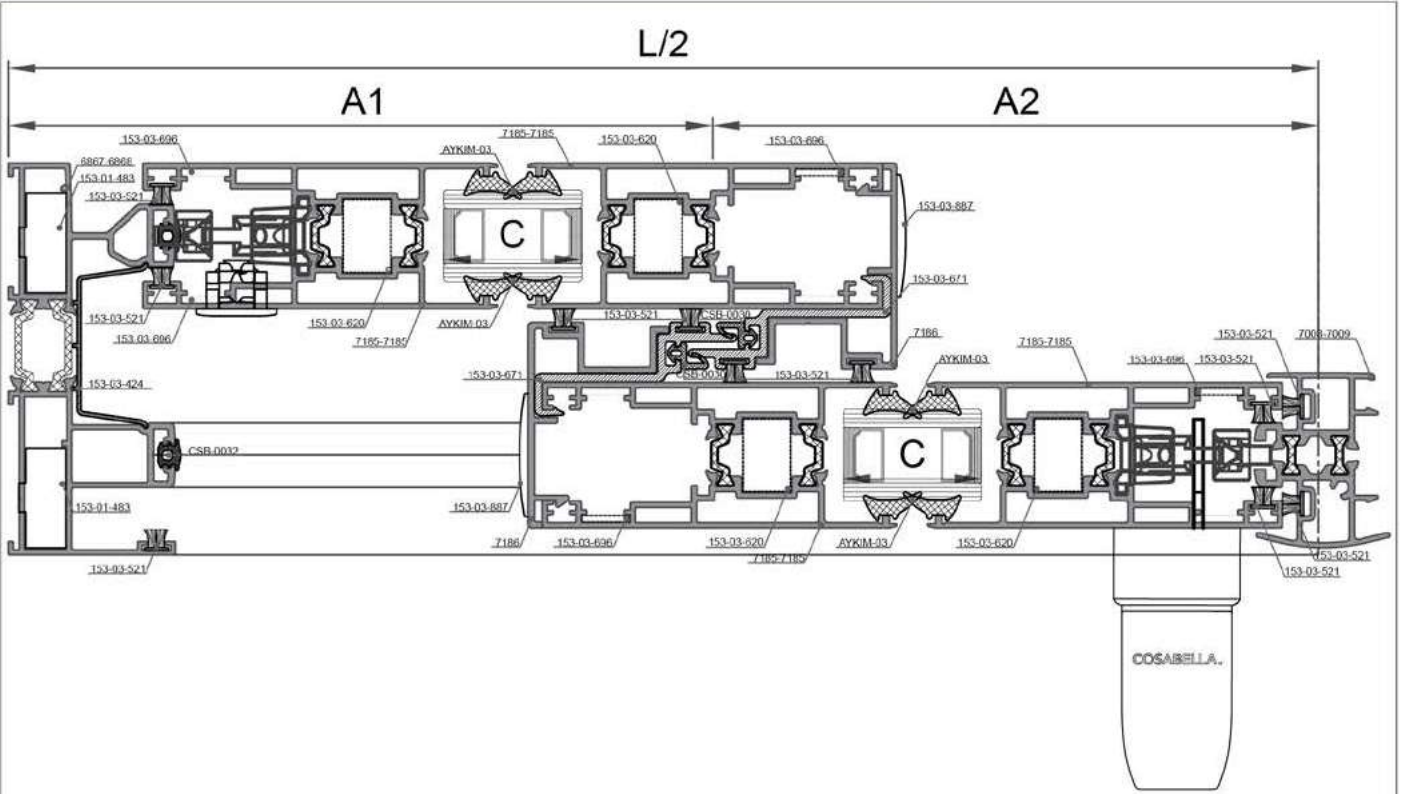
Kesim ölçüsü - cam ölçüsü vb. sorumluluğu tarafımıza ait değildir.

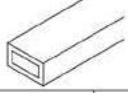
Ölçek: 1:2 / Scale: 1:2





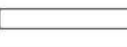
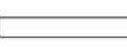

			
Kasa Genişlik Frame Width	6867-6868		2 Ad. 2 Pcs. L
Kasa Yükseklik Frame Height	6867-6868		2 Ad. 2 Pcs. H
Kanat Yükseklik Sash Height	7185-7185		8 Ad. 8 Pcs. H-70
Kanat Genişlik Sash Width	7185-7185		8 Ad. 8 Pcs. L/2+9,4
Kenet Kanat Yükseklik Sash Height	7186		4 Ad. 4 Pcs. H-70
Adaptör Profil Yükseklik Adapter Profile Height	7008-7009		1 Ad. 1 Pcs. H-106
Kanat Cam Genişlik Glazing Sash Width			4 Ad. 4 Pcs. A1-147,6
Kanat Cam Yükseklik Glazing Sash Height			4 Ad. 4 Pcs. H-227

45° Klasik Sürme
45° Classical Slide

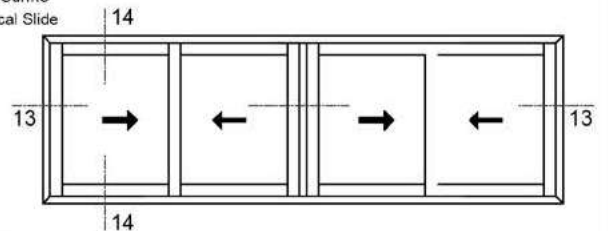

Kesim ölçüsü - cam ölçüsü vb. sorumluluğu tarafımıza ait değildir.

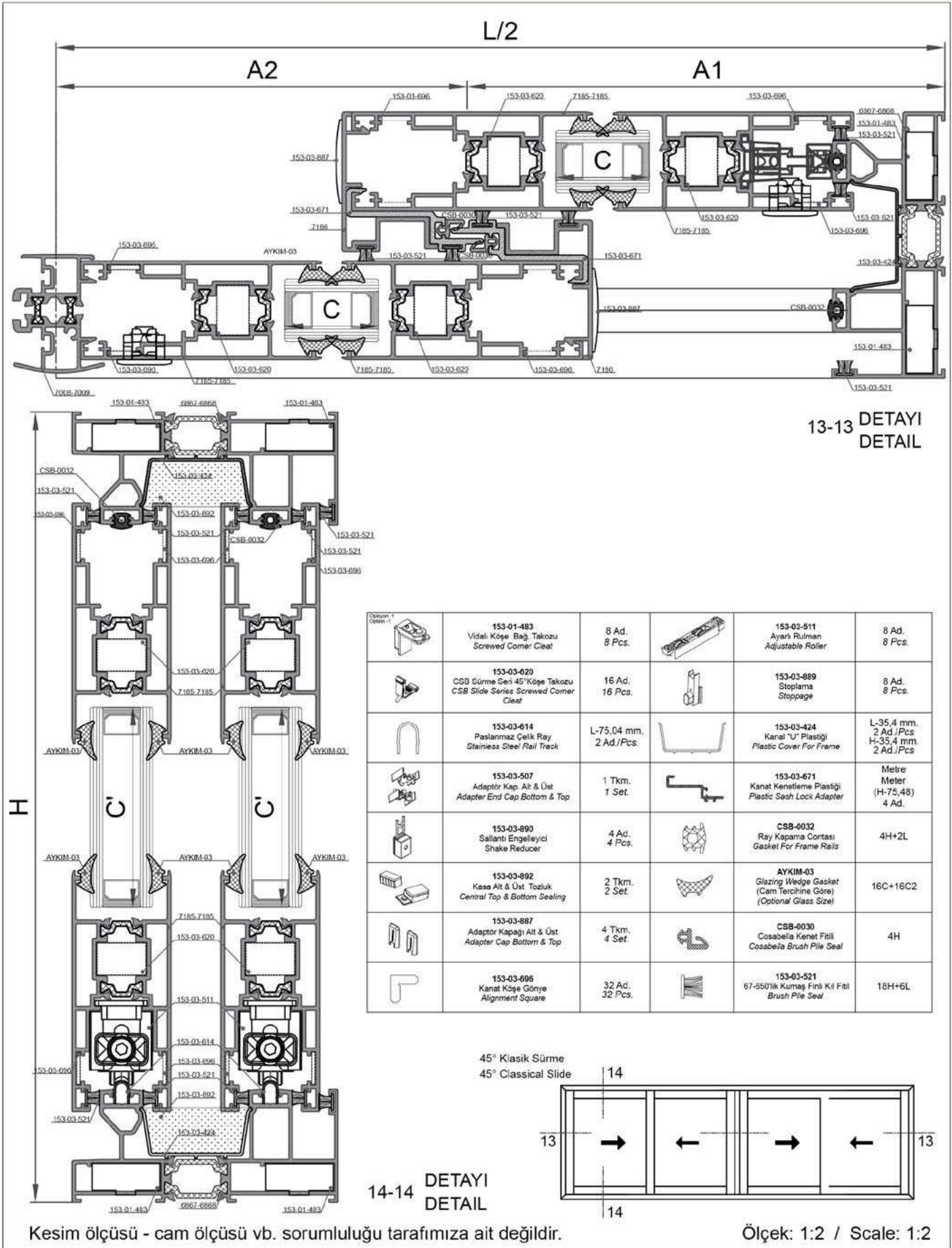

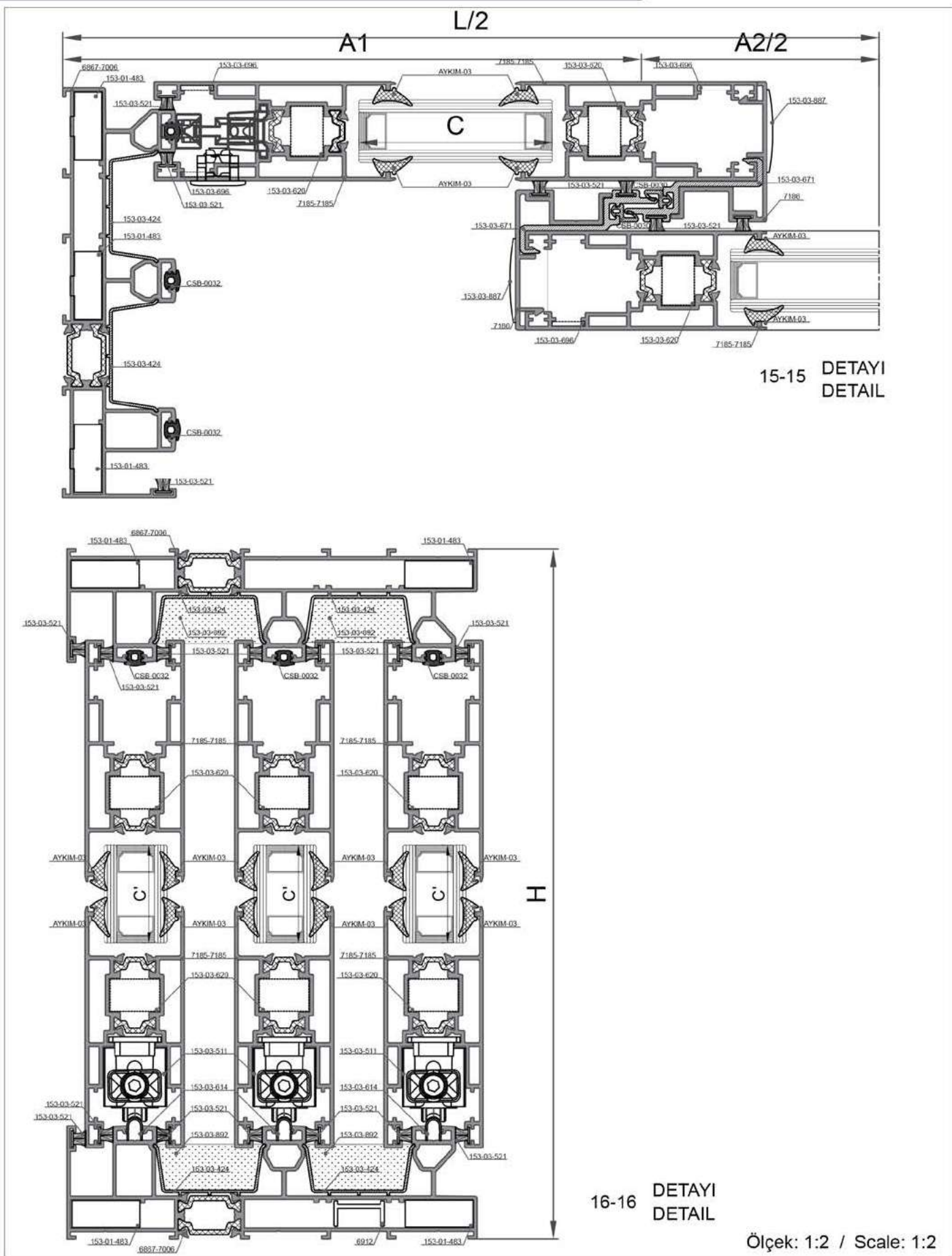

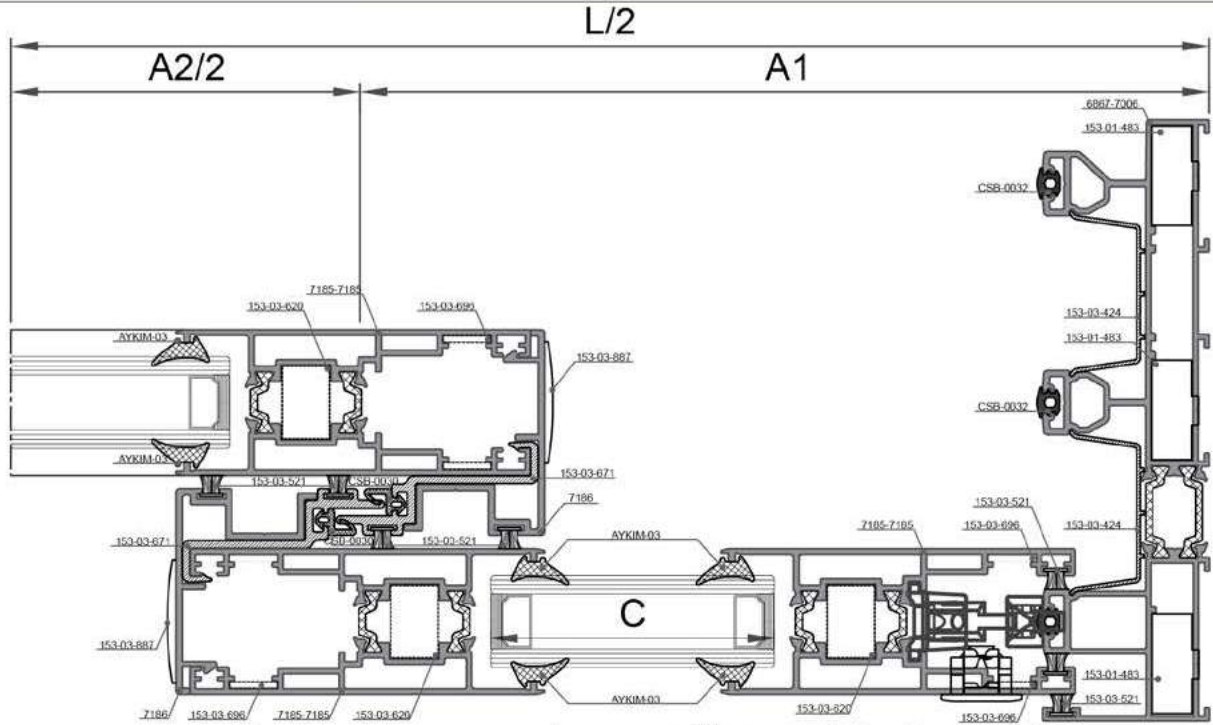

 15-15 DETAYI
 DETAIL

					mm.
Kasa Genişlik Frame Width	6867-7006			2 Ad. 2 Pcs.	L
Kasa Yükseklik Frame Height	6867-7006			2 Ad. 2 Pcs.	H
Kanat Yükseklik Sash Height	7185-7185			2 Ad. 2 Pcs.	H-70
Yatay Kanat Genişlik Horizontal Sash Width	7185-7185			6 Ad. 6 Pcs.	A1+9,4
Kenet Kanat Yükseklik Sash Height	7186			1 Ad. 1 Pcs.	H-70
Kanat Cam Genişlik Glazing Sash Width				3 Ad. 3 Pcs.	A1-147,6
Kanat Cam Yükseklik Glazing Sash Height				3 Ad. 3 Pcs.	H-227

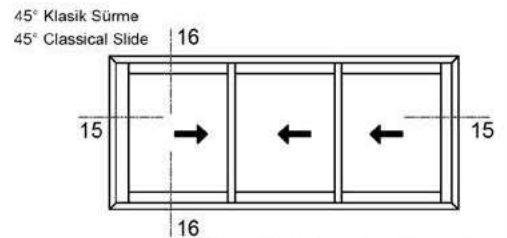
	153-01-483 Vidalı Köşe Bağ, Takozu Screwed Corner Cleat	12 Ad. 12 Pcs.		153-03-511 Ayarlı Rulman Adjustable Roller	8 Ad. 6 Pcs.
	153-03-620 CSB Sürme Seri 45° Köşe Takozu CSB Slide Series Screwed Corner Cleat	12 Ad. 12 Pcs.		153-03-889 Stoplama Stoppage	6 Ad. 6 Pcs.
	153-03-614 Paslanmaz Çelik Ray Stainless Steel Rail Track	L-75,04 mm. 3 Ad./Pcs.		153-03-671 Kanat Kenetleme Plastik Plastic Sash Lock Adapter	Metre Meter (H-75,48) 4 Ad.
	153-03-424 Kanal "U" Plastik Plastic Cover For Frame	L-35,4 mm. 2 Ad./Pcs. H-35,4 mm. 2 Ad./Pcs.		153-03-521 67-650'lık Kumuş Fırıl Kıl Fırlı Brush Pile Seal	14H+8L
	153-03-892 Kasa Alt & Üst Tozluk Central Top & Bottom Sealing	2 Tkm. 2 Set.		CSB-0032 Ray Kapama Contası Gasket For Frame Rails	6H+3L
	153-03-887 Adaptör Kapağı Alt & Üst Adapter Cap Bottom & Top	4 Tkm. 4 Set.		AYKIM-03 Glazing Wedge Gasket (Cam Tercihine Göre) (Optional Glass Size)	12C+12C2
	153-03-696 Kanat Köşe Gönye Alignment Square	24 Ad. 24 Pcs.		CSB-0030 Cosabella Kenet Fırlı Cosabella Brush Pile Seal	4H
	153-03-890 Sallantı Engelleyici Shake Reducer	4 Ad. 4 Pcs.			



Kesim ölçüsü - cam ölçüsü vb. sorumluluğu tarafımıza ait değildir.

Ölçek: 1:2 / Scale: 1:2

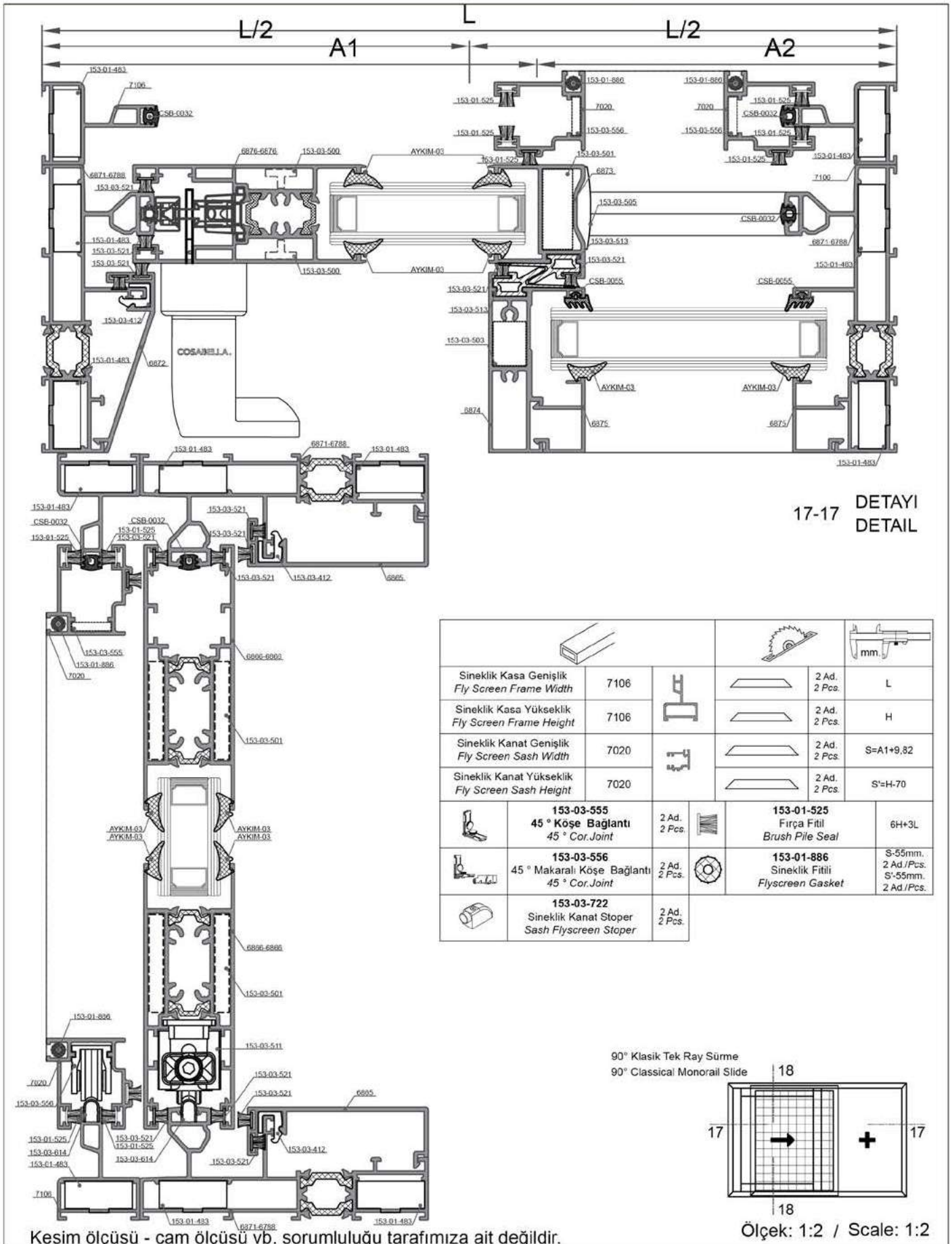

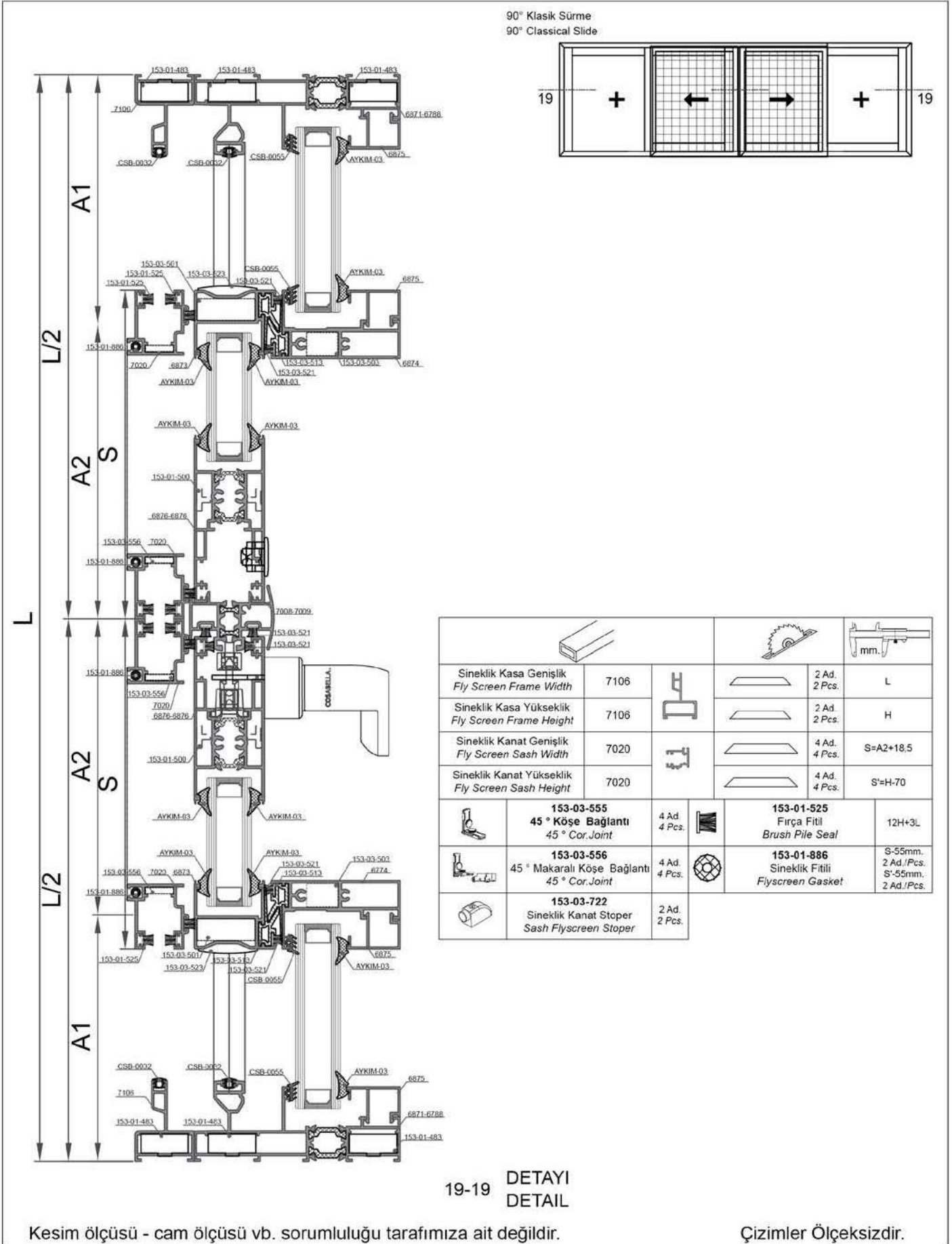

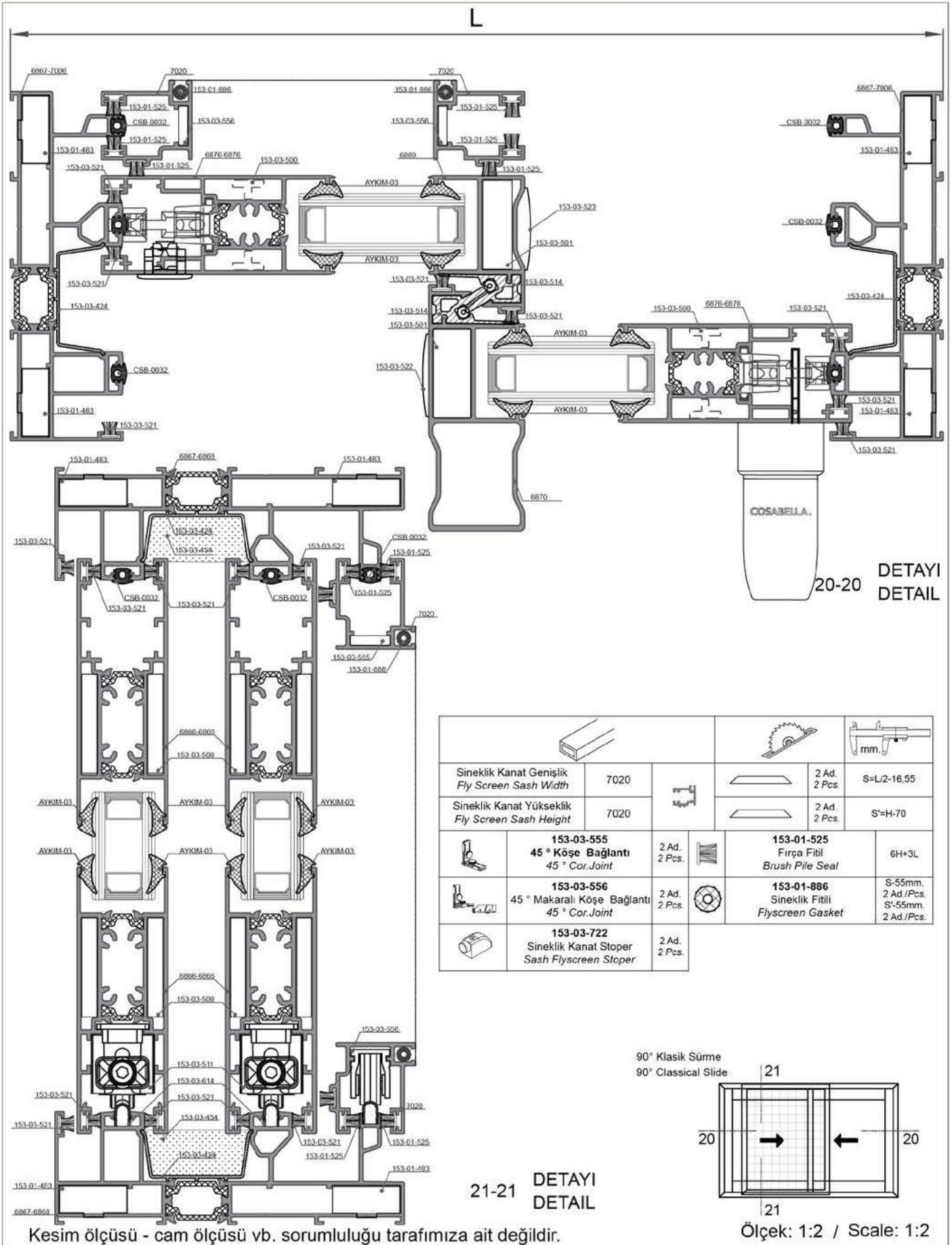

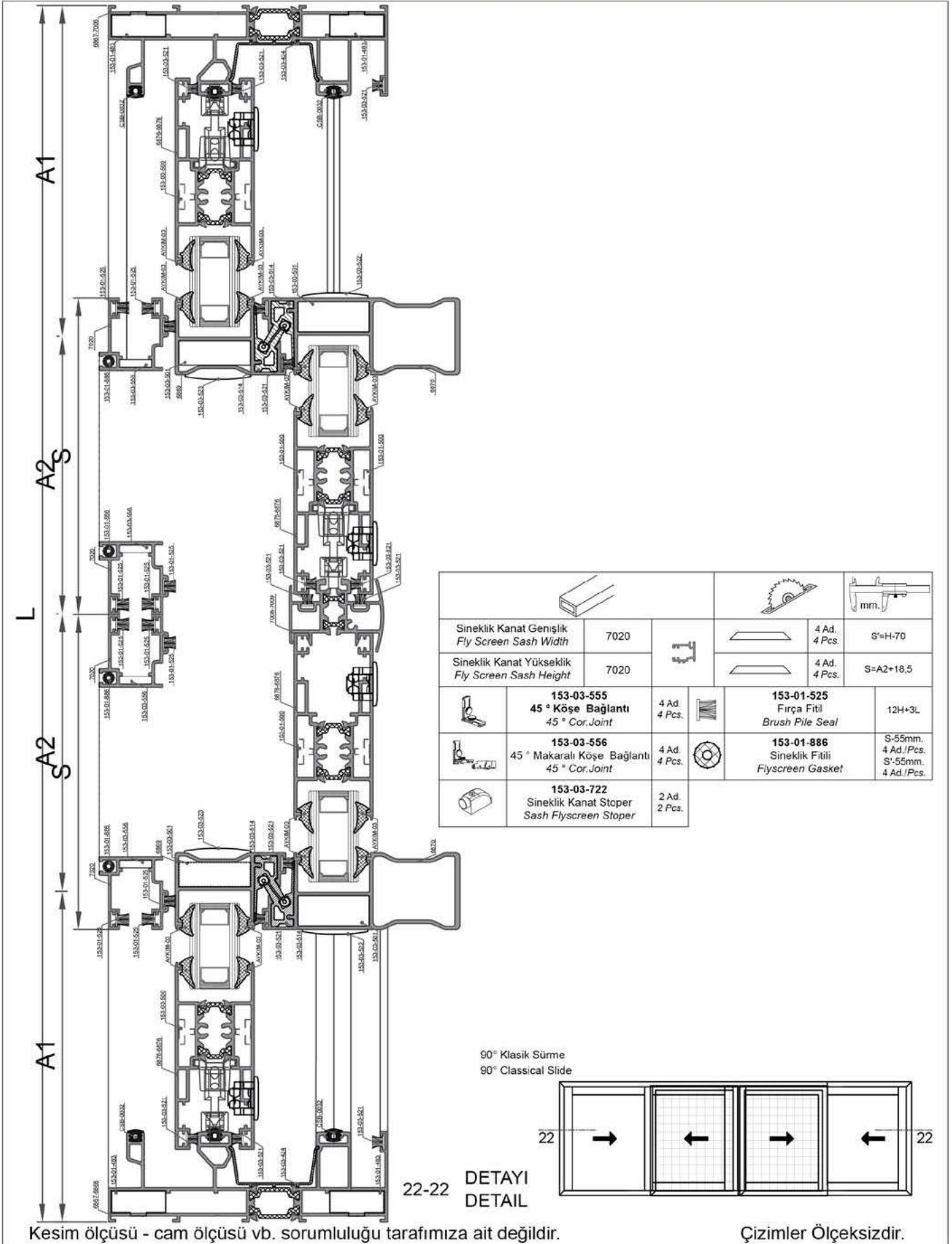

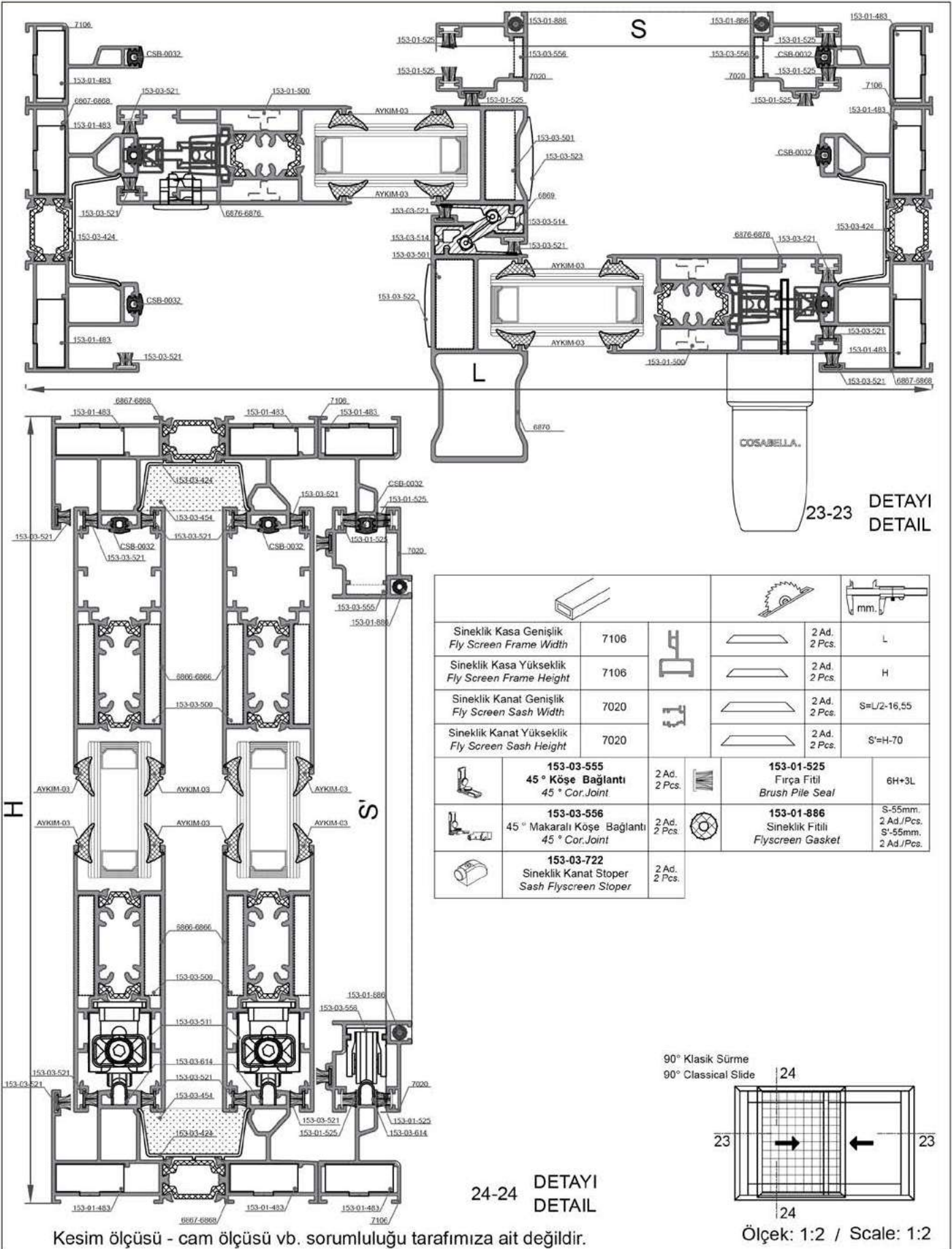

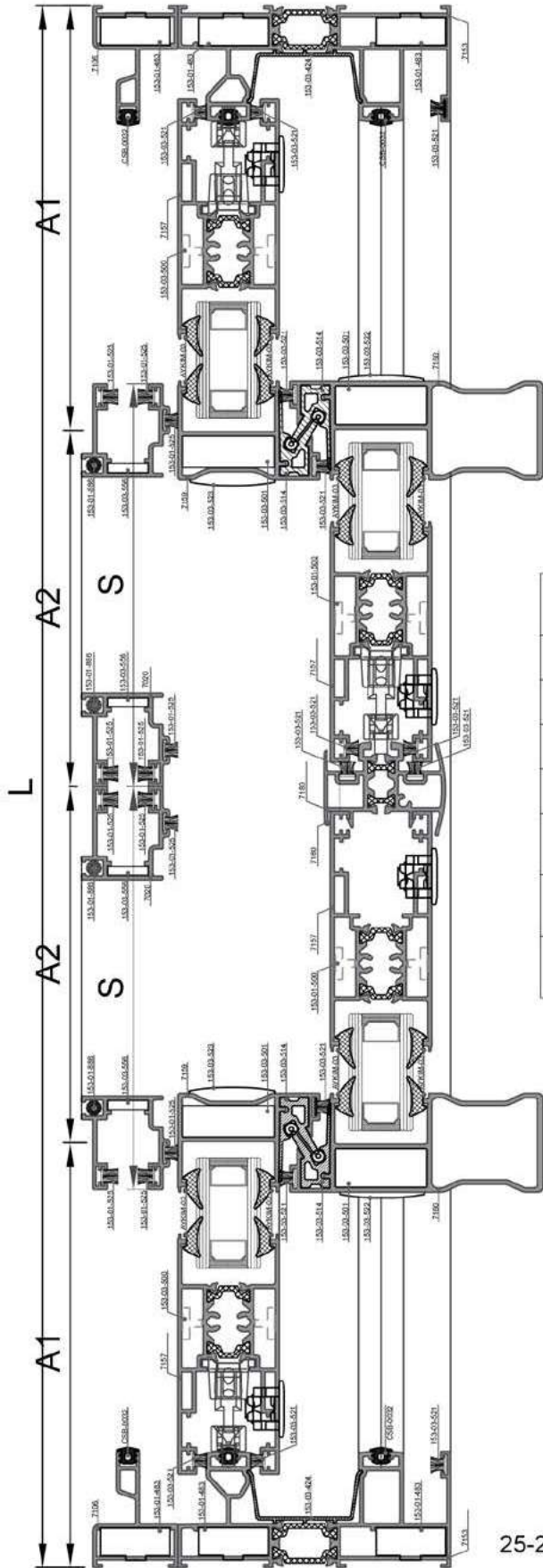













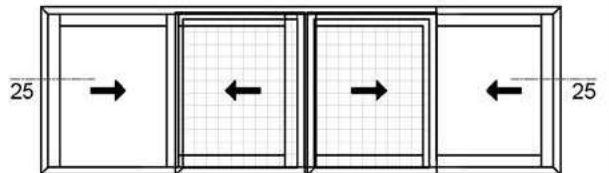

	Sineklik Kasa Genişlik Fly Screen Frame Width	7106			2 Ad. 2 Pcs.
	Sineklik Kasa Yükseklik Fly Screen Frame Height	7106			2 Ad. 2 Pcs.
	Sineklik Kanat Genişlik Fly Screen Sash Width	7020			4 Ad. 4 Pcs.
	Sineklik Kanat Yükseklik Fly Screen Sash Height	7020			4 Ad. 4 Pcs.
	153-03-555 45° Köşe Bağlantı 45° Cor.Joint	4 Ad. 4 Pcs.		153-01-525 Fırça Fitol Brush Pile Seal	12H+3L
	153-03-556 45° Makaralı Köşe Bağlantı 45° Cor.Joint	4 Ad. 4 Pcs.		153-01-886 Sineklik Fitol Flyscreen Gasket	S-55mm. 4 Ad./Pcs. S'-55mm. 4 Ad./Pcs.
	153-03-722 Sineklik Kanat Stoper Sash Flyscreen Stoper	2 Ad. 2 Pcs.			

 90° Klasik Süreme
 90° Classical Slide

 25-25
 DETAYI
 DETAIL

Kesim ölçüsü - cam ölçüsü vb. sorumluluğu tarafımıza ait değildir.

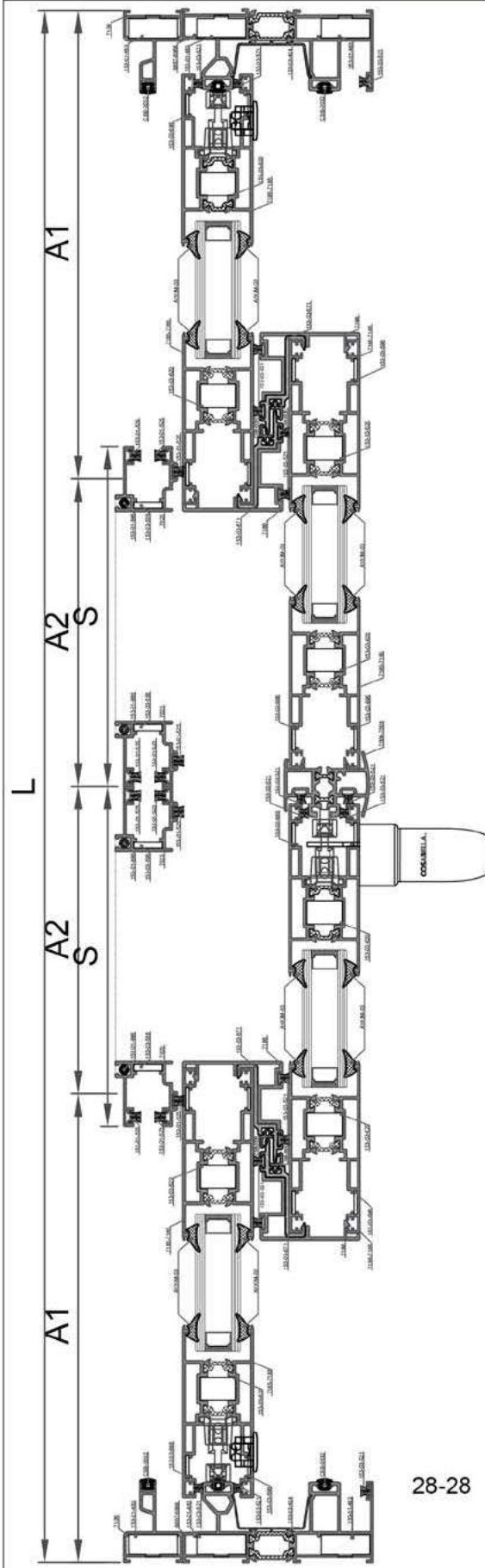
Çizimler Ölçeksizdir.

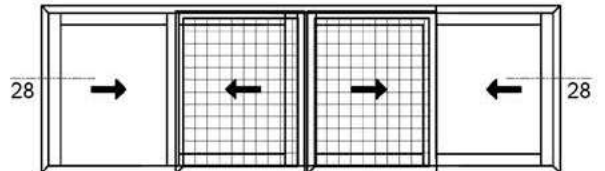

				mm.
Sineklik Kasa Genişlik Fly Screen Frame Width	7106		2 Ad. 2 Pcs.	L
Sineklik Kasa Yükseklik Fly Screen Frame Height	7106		2 Ad. 2 Pcs.	H
Sineklik Kanat Genişlik Fly Screen Sash Width	7020		4 Ad. 4 Pcs.	S=A2-48,1
Sineklik Kanat Yükseklik Fly Screen Sash Height	7020		4 Ad. 4 Pcs.	S'=H-70
	153-03-555 45° Köşe Bağlantı 45° Cor.Joint	4 Ad. 4 Pcs.		153-01-525 Fırça Fitol Brush Pile Seal
	153-03-556 45° Makaralı Köşe Bağlantı 45° Cor.Joint	4 Ad. 4 Pcs.		153-01-886 Sineklik Fitolü Flyscreen Gasket
	153-03-722 Sineklik Kanat Stoper Sash Flyscreen Stoper	2 Ad. 2 Pcs.		12H+3L

 45° Klasik Sürme
 45 Classical Slide

 28-28
 DETAYI
 DETAIL

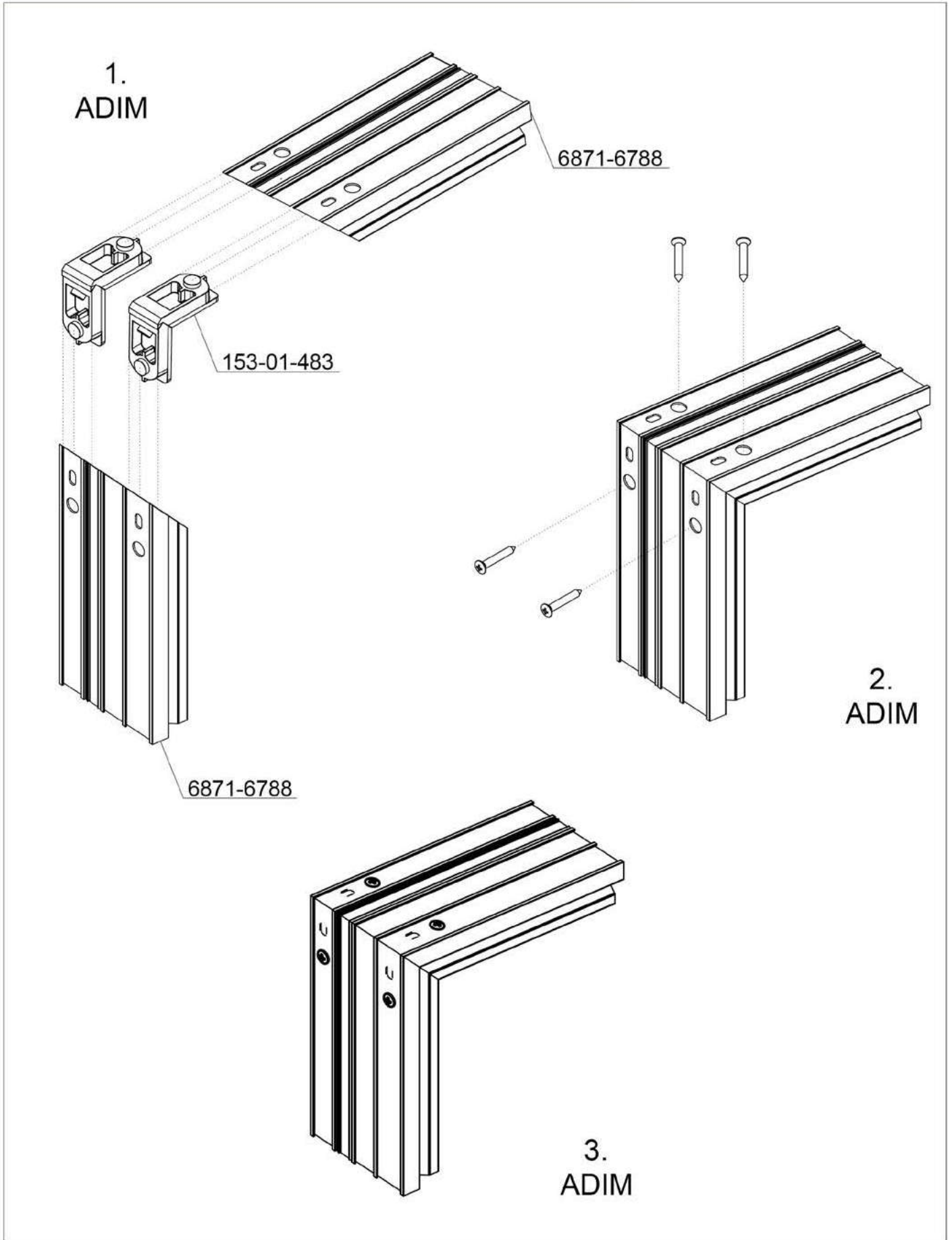
 Kesim ölçüsü - cam ölçüsü vb. sorumluluğu tarafımıza ait değildir.
 Çizimler Ölçeksizdir.

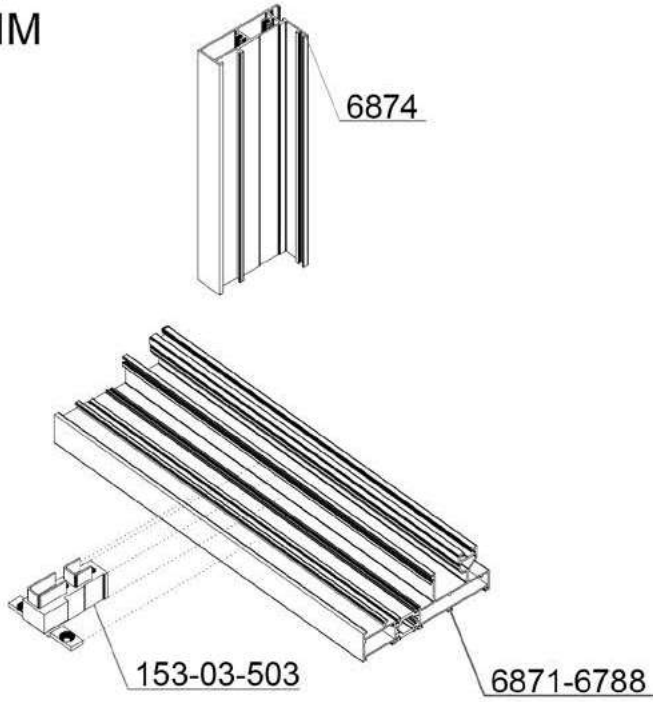

1.
ADIM



3.
ADIM

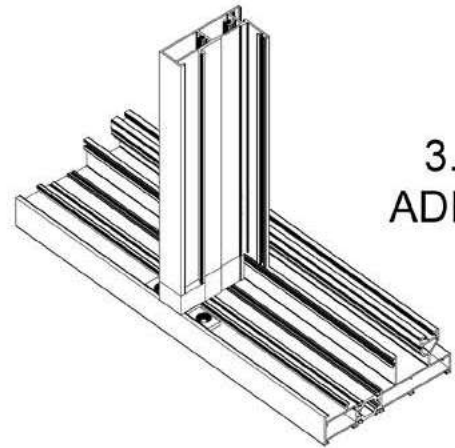

2.
ADIM

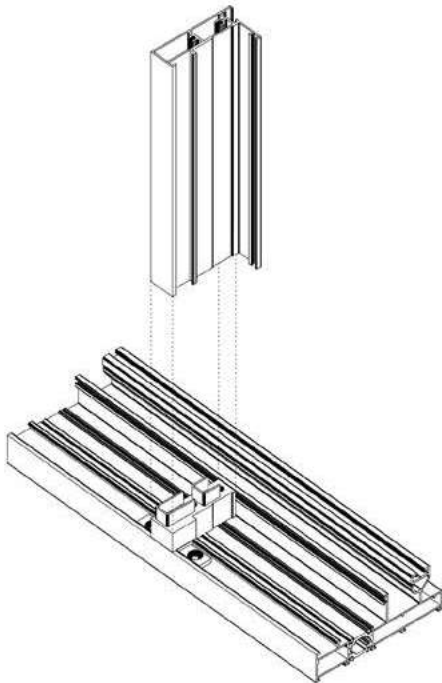

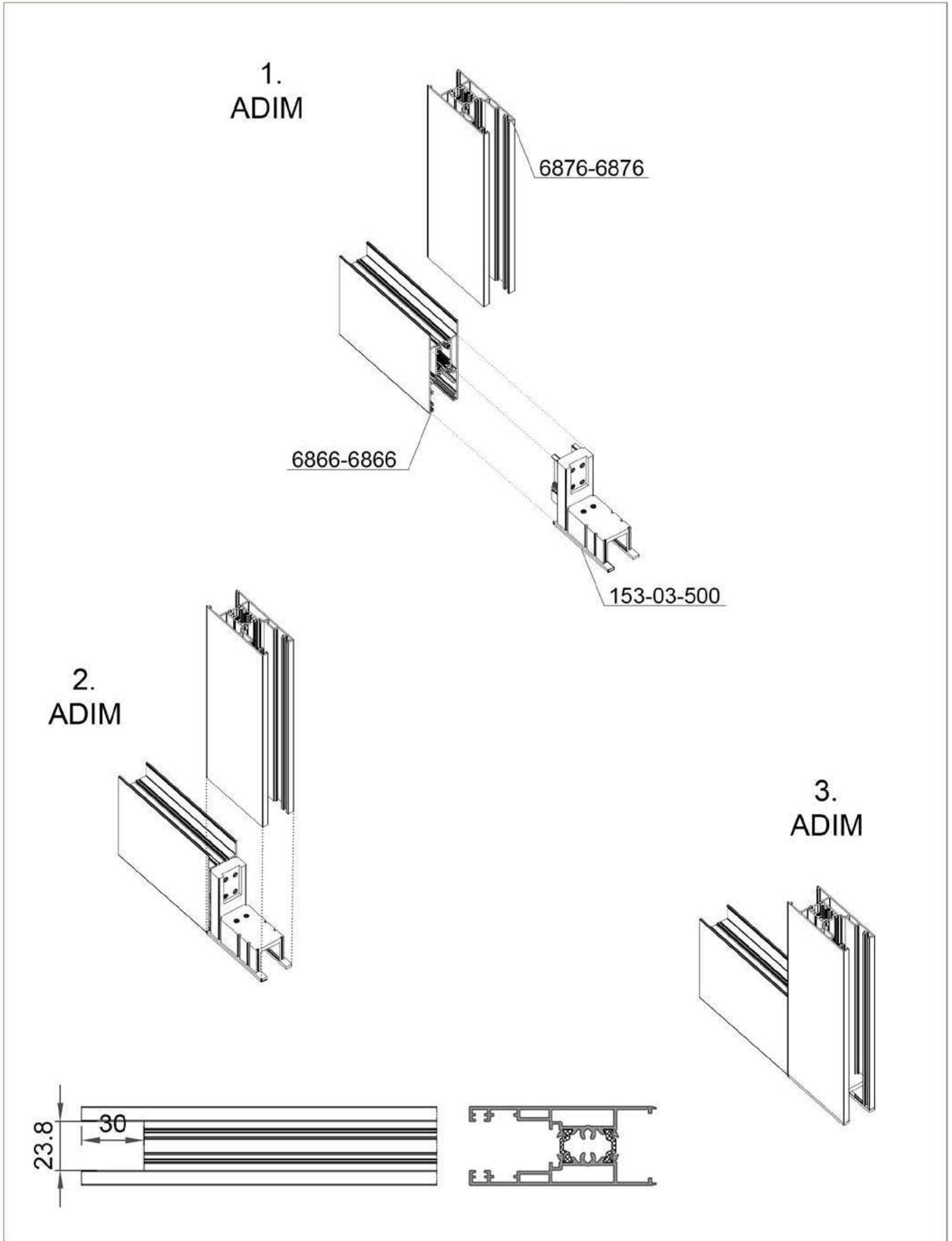

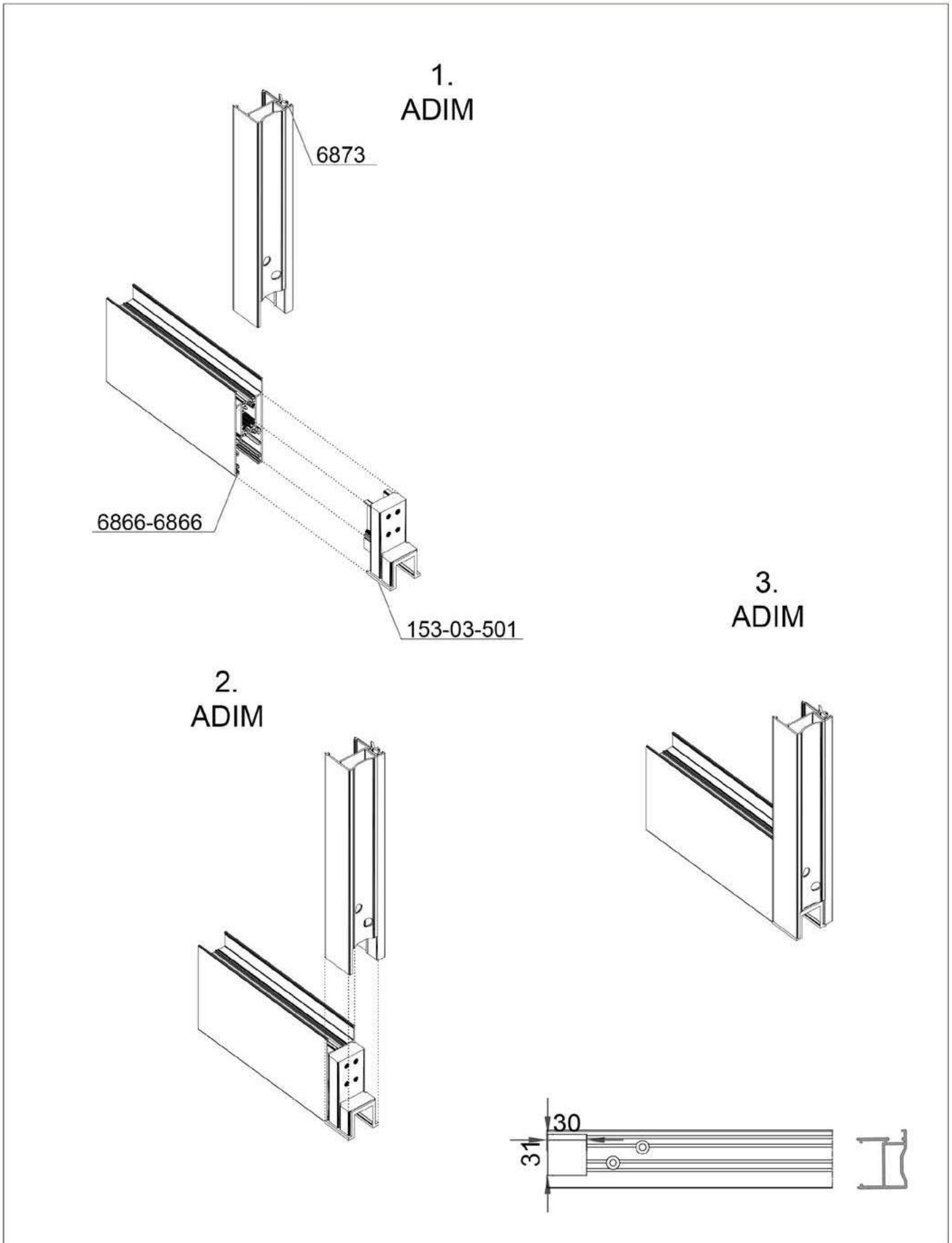

1.
ADIM

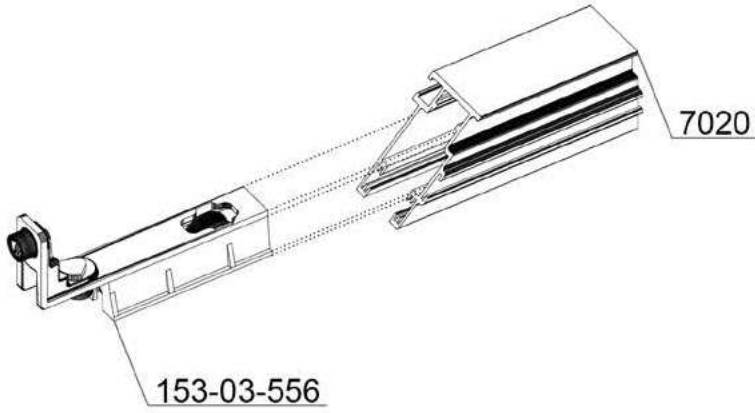
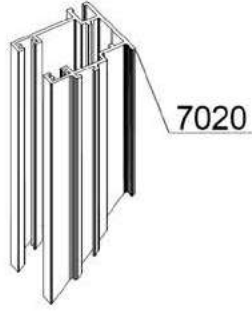



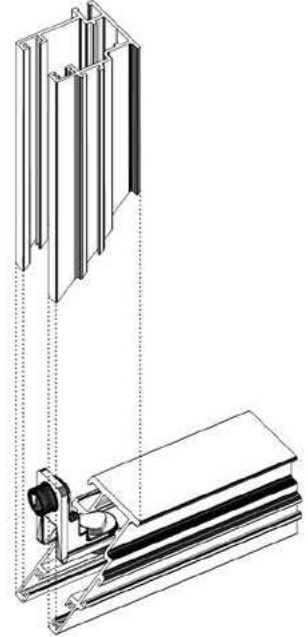



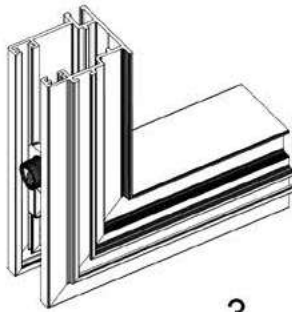





2.
ADIM





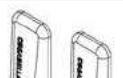

















3.
ADIM



Ürün Çizimi Drawing	Ürün Kodu Product No	Ürün Adı Product Name	Kullanıldığı Profiller Profiles Used
	153-01-483	Kasa Bağlantı Takoğu 11/26 <i>Joint Corner</i>	6871-6788 6867-6868 6867-7006 6867-7007
	153-03-500	90° Geniş Köşe Bağlantı Takoğu <i>90° Wide Sash Cor.Joint</i>	6876-6876 6866-6866
	153-03-501	90° Dar Köşe Bağlantı Takoğu <i>90° Narrow Sash Cor.Joint</i>	6869 / 6870 / 6873 6780-6780
	153-03-503	90° Dar Köşe Bağlantı Takoğu <i>90° Narrow Sash Cor.Joint</i>	6874 6871-6788
	153-03-620	Sürme Seri 45° Köşe Takoğu <i>Slide Series Screwed Corner Cleat</i>	-
	153-03-696	Kanat Köşe Gönye <i>Alignment Square</i>	-
	153-03-504	Kasa Alt & Üst Tozluk <i>Central Top & Bottom Sealing</i>	-
	153-03-454	Kasa Alt & Üst Tozluk <i>Central Top & Bottom Sealing</i>	-
	153-03-892	45° Kasa Alt & Üst Tozluk <i>Central Top & Bottom Sealing</i>	-
	153-03-887	45° Adaptör Kapağı Alt & Üst <i>Adapter Cap Bottom & Top</i>	7186
	153-03-505	Adaptör Kapağı Alt & Üst <i>Adapter Cap Bottom & Top</i>	6873
	153-03-522	Takviyeli Adaptör Kapağı Alt & Üst <i>Adapter Cap Bottom & Top</i>	6870





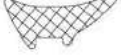

Ürün Çizimi Drawing	Ürün Kodu Product No	Ürün Adı Product Name	Kullanıldığı Profiller Profiles Used
	153-03-523	Takviyesiz Adaptör Kapağı Alt & Üst Adapter Cap Bottom & Top	6869
	153-03-506	SD-33 Kenetli Alt - Üst Kulp Kapağı SD-33 Sash Bottom & Top Cap	-
	153-03-507	4'lü Kanat Adaptör Kapağı 4 Winged Lid	-
	153-03-508	Stoplama Stoppage	-
	153-03-412	Adaptör Kenetleme Klipsi Plastic Lock Clips	-
	153-03-890	Sallantı Engelleyici Shake Reducer	-
	153-03-513	Kanat Kenetleme Plastiği Plastic Sash Lock Adapter	-
	153-03-514	Kanat Kenetleme Plastiği Plastic Sash Lock Adapter	-
	153-03-671	Kanat Kenetleme Plastiği Plastic Sash Lock Adapter	-
	153-03-424	Kanal "U" Plastiği Plastic Cover For Frame	-
	153-03-511	Ayarlı Rulman Adjustable Roller	-
	153-03-614	Paslanmaz Çelik Ray Stainless Steel Rail Track	-

Ürün Çizimi Drawing	Ürün Kodu Product No	Ürün Adı Product Name	Kullanıldığı Profiller Profiles Used
	153-02-789	Tahliye Tapası Drain Plug	-
	153-03-509	Sabitleme Takoğu Fixing Wedge	-
	153-03-510	Sabitleme Aparatı Fixing Device	-
	153-01-356	Polyamid Tij Polyamide Tij	-
	153-03-423	Tijli Sistem Karşılığı Equipment For Tiji System	-
	153-03-973	COSABELLA Kilitleme Parçası COSABELLA Locking Part	-
	153-03-986	Stac Eksenel Kol Spades Handle 986-Siyah 986-Black	-
	153-03-479	Stac Kıvrık Eksenel Kol Sol Spades Handle 478-Siyah 478-Black	-
	153-03-478	Stac Kıvrık Eksenel Kol Sağ Spades Handle 479-Siyah 479-Black	-
	153-03-317	Tijli Gömme Kilit Pimi Tij Mixed Lock Pin	-
	153-03-802 153-03-813 153-03-815	Tijli Gömme Kilit Mixed Lock With Hinge 802- renkli, 813- Eloksal, 815- Beyaz 802- Color, 813- Silver, 815- White	-
	153-03-801 153-03-812 153-03-814	Tijli Gömme Kilit Karşılığı Mixed Lock With Hinge 801- renkli, 812- Eloksal, 814- Beyaz 801- Color, 812- Silver, 814- White	-

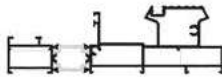
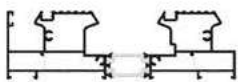
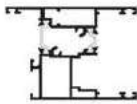
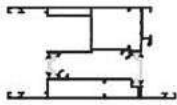
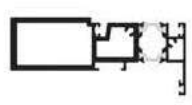
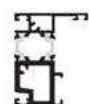
Ürün Çizimi Drawing	Ürün Kodu Product No	Ürün Adı Product Name	Kullanıldığı Profiller Profiles Used
	153-03-722	Sineklik Kanat Stoper <i>Sash Flyscreen Stoper</i>	-
	153-03-555	45° Köşe Bağlantı Takozu <i>45° Corner Joint</i>	-
	153-03-556	45° Makaralı Köşe Bağlantı Takozu <i>45° Corner Joint</i>	-
	CSB-0030	Kenet Fiteli <i>Brush Pile Seal</i>	-
	153-01-525	Fırça Fitel <i>Brush Pile Seal</i>	-
	153-03-521	67-650'lik Kumaş Finli Kıl Fitel <i>Brush Pile Seal</i>	-
	CSB-0032	Ray Kapama Contası <i>Gasket For Frame Rails</i>	-
	153-01-886	Sineklik Fiteli <i>Flyscreen Gasket</i>	-
	CSB-0055	Dış Cam Contası <i>External Glass Gasket</i>	-
	AYKIM-03	Glazing Wedge Gasket <i>(Cam Tercihine Göre)</i> <i>(Optional Glass Size)</i>	-

SD22
SD23
SD32
SD33
SD35
WD42
WD52
FS72

SD35

Profil Profile	Profil Kodu Profile Nr	Ağırlık (kg/m.) Weight (kg/m.)	X mm.	Y mm.	Jx cm ⁴	Jy cm ⁴
	7422-7380 Sürme Tekli Kasa Profili Sliding Frame Profile	2,318 kg/m	31,0 mm	65,0 mm	Jx cm	Jy cm
	7365-7366 Sürme Kasa Profili Sliding Frame Profile	2,564 kg/m	110,0 mm	60,0 mm	194,57	18,71
	7370-7371 Kilit Kanat Profili Sash Profile	1,879 kg/m	85,1 mm	60,0 mm	33,49	25,77
	7367-7368 Yatay Kanat Profili Horizontal Sash Profile	2,396 kg/m	110,0 mm	94,0 mm	70,79	41,36
	7372-7374 Takviyeli Kenet Kanat Sash Profile	3,012 kg/m	113,6 mm	47,1 mm	146,82	17,16
	7372-7373 Takviyesiz Kenet Kanat Profili Sash Profile	1,658 kg/m	47,1 mm	60,0 mm	23,88	7,21
	7424 Tekli Kasa Adaptör Profili Adapter Profile	0,696 kg/m	19,6 mm	75,5 mm	1,09	16,9
	7423 Tekli Kasa Adaptör Profili Adapter Profile	0,600 kg/m	10,4 mm	77,5 mm	12,7	0,52
	6875 Cam Çita Profili Glass Bead Profile	0,271 kg/m	29,0 mm	16,1 mm	-	-
	7369 Tekli Kasa Adaptör Profili Adapter Profile	0,303 kg/m	20,0 mm	21,2 mm	-	-
	7414 Adaptör Profili Adapter Profile	0,406 kg/m	77,0 mm	9,4 mm	-	-

Sürme Tekli Kasa Profili - Sliding Frame Profile
7422-7380
2,222 kg/mt

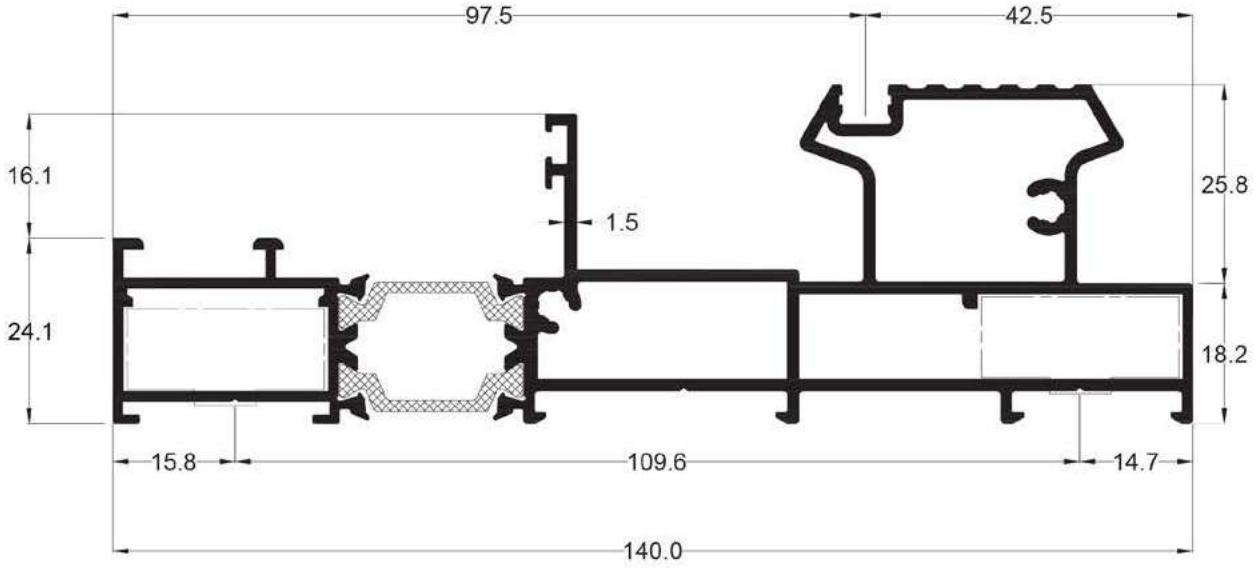

7422-7380

Kod/Code	Et Kalın./Wall Thk.	Ürün Adı / Prod. Name	Ağırlığı / Weight	Köşe Takoğu / C. Cleat
7422-7380	1.5 mm	Sürmeli Tekli Kasa Pr. / Sliding Frame Pr.	2.222 kg/mt	1.5

Sürme Kasa Profili - Sliding Frame Profile
7365-7366
2,564 kg/mt

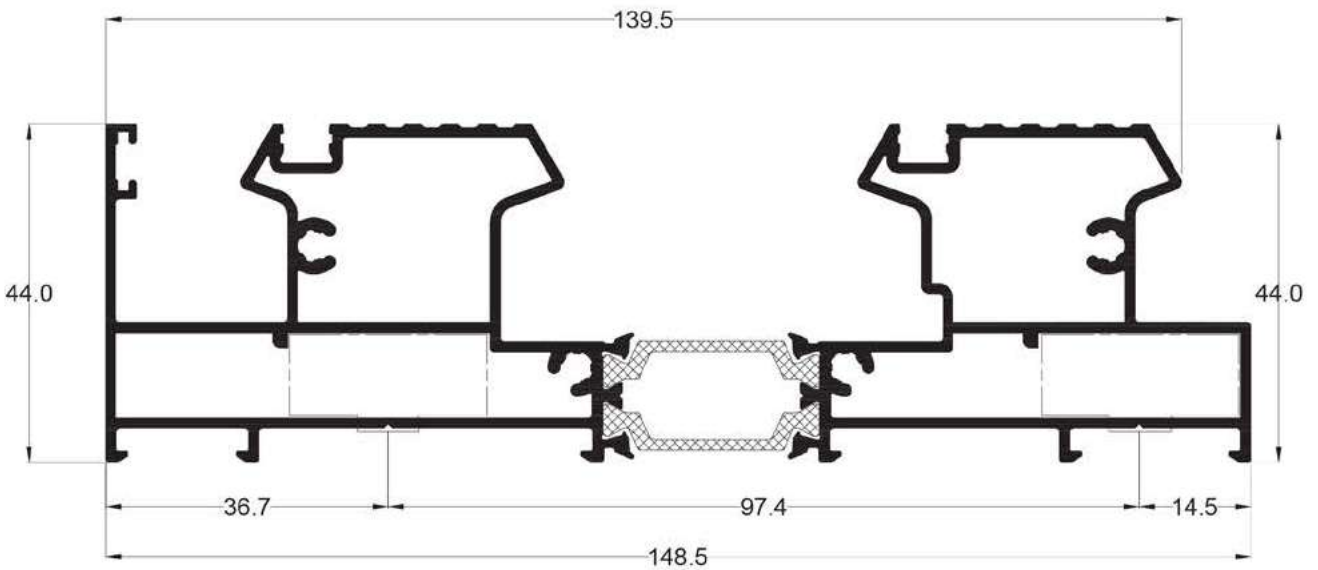

7365-7366

Kod/Code	Et Kalın./Wall Thk.	Ürün Adı / Prod. Name	Ağırlığı / Weight	Köşe Takoğu / C. Cleat
7365-7366	1.4 mm	Sürme Kasa Profili / Sliding Frame Pr.	2.564 ka/mt	-

Kilit Kanat Profili - Sash Profile
 7370-7371
 1,875 kg/mt

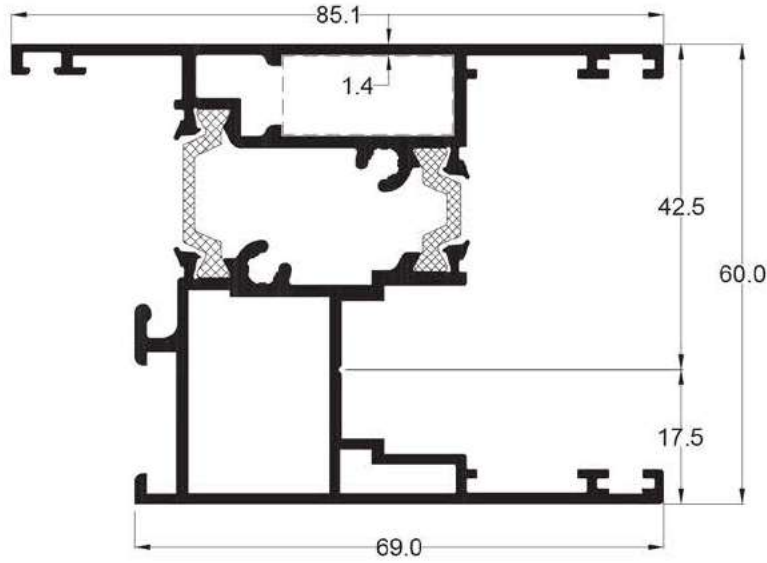

7370-7371

Kod/Code	Et Kalın./Wall Thk.	Ürün Adı / Prod. Name	Ağırlığı /Weight	Köşe Takozu / C. Cleat
7370-7371	1.4 mm	Kilit Kanat Profili / Locking Sash Pr.	1,875 kg/mt	-

Yatay Kanat Profili - Horizontal Sash Profile
 7367-7368
 2,369 kg/mt

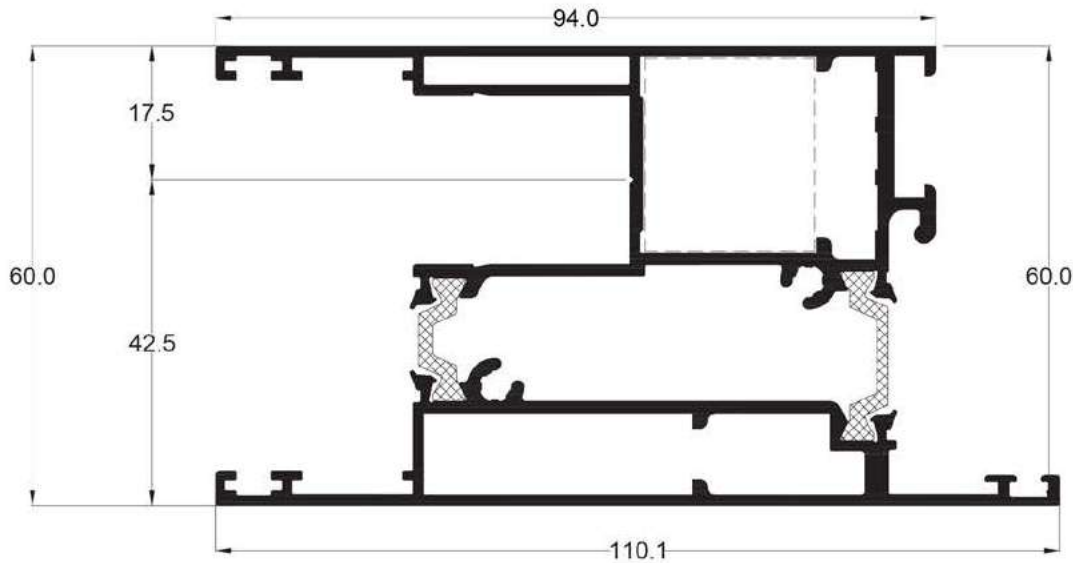

7367-7368

Kod/Code	Et Kalın./Wall Thk.	Ürün Adı / Prod. Name	Ağırlığı /Weight	Köşe Takozu / C. Cleat
7367-7368	1.5 mm	Yatay Kanat Pr. / Horizontal Sash Pr.	2,369 kg/mt	1.5

Takviyeli Kenet Kanat Profili - Sash Profile
7374-7372
3,025 kg/mt

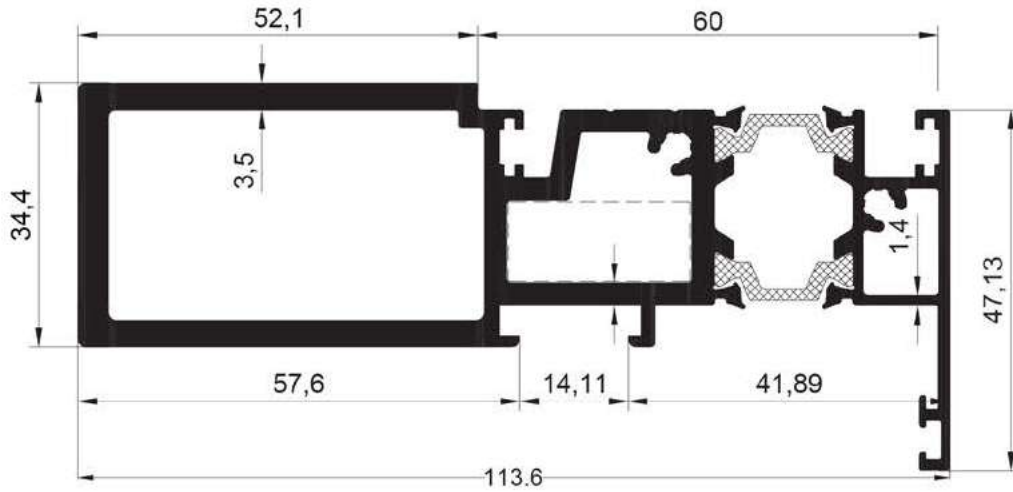

7374-7372

Kod/Code	Et Kalın./Wall Thk.	Ürün Adı / Prod. Name	Ağırlığı / Weight	Köşe Takozu / C. Cleat
7374-7372	1.4 mm	Takviyeli Kanat / Reinforced Sash Pr.	3.025 kg/mt	1.5

Takviyesiz Kenet Kanat Profili - Sash Profile
7372-7373
1,670 kg/mt

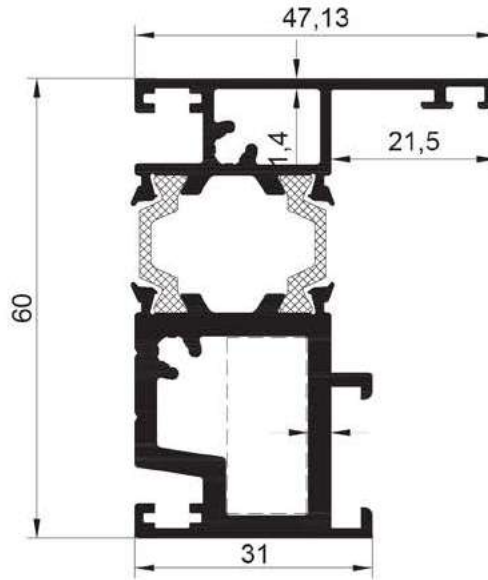

7372-7373

Kod/Code	Et Kalın./Wall Thk.	Ürün Adı / Prod. Name	Ağırlığı / Weight	Köşe Takozu / C. Cleat
7372-7373	1.4 mm	Takviyesiz Kanat / Non-Reinforced Sash Pr.	1.670 kg/mt	-

Tekli Kasa Adap. Pro.- Adapter Profile
 7424
 0,696 kg/mt

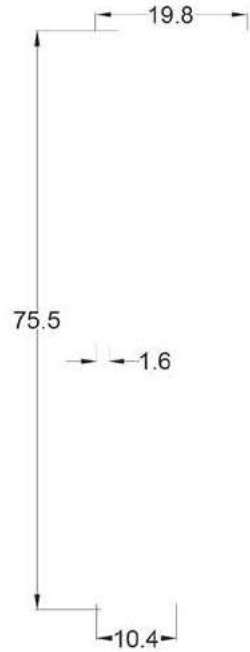

7424

Tekli Kasa Adap. Pro. - Adapter Profile
 7423
 0,600 kg/mt

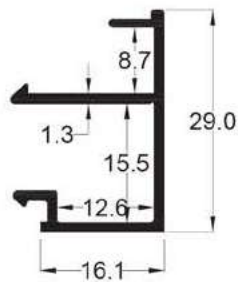

7423

Kod/Code	Et Kalın./Wall Thk.	Ürün Adı / Prod. Name	Ağırlığı / Weight	Köşe Takozu / C. Cleat
7424	1.6 mm	Tekli Kasa Ad. Pr. / Adapter Profile	0,696 kg/mt	1.5
7423	1.8 mm	Tekli Kasa Ad. Pr. / Adapter Profile	0,609 kg/mt	1.5

Cam Çita Profili - Glazing Bead Profile
 6875
 0,272 kg/mt

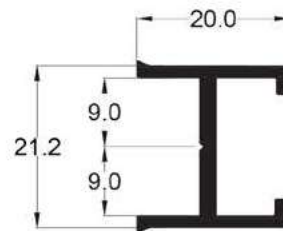

6875

Adap. Pro. - Adapter Profile
 7369
 0,305 kg/mt

7369

Kod/Code	Et Kalın./Wall Thk.	Ürün Adı / Prod. Name	Ağırlığı / Weight	Köşe Takozu / C. Cleat
6875	1.3 mm	Cam Çita Profili / Glazing Bead Profile	0,271 kg/mt	-
7369	1.6 mm	Adaptör Pr. / Adapter Profile	0,305 kg/mt	-

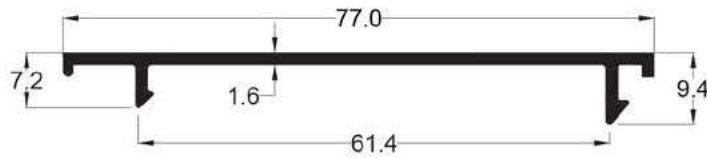
Adap. Pro. - Adapter Profile
7414
0,407 kg/mt



7414

Kod/Code	Et Kalın./Wall Thk.	Ürün Adı / Prod. Name	Ağırlığı / Weight	Köşe Takozu / C. Cleat
7414	1.6 mm	Adaptör Pr. / Adapter Profile	0,407 kg/mt	1.5

Orta Kilit Profili
7415-7415
0,941 kg/mt

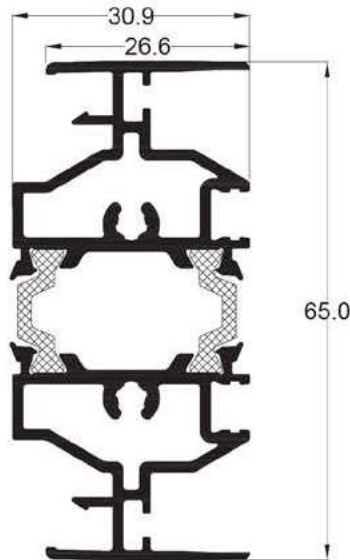

7415-7415

Kod/Code	Et Kalın./Wall Thk.	Ürün Adı / Prod. Name	Ağırlığı / Weight	Köşe Takozu / C. Cleat
7415-7415	3 mm	Orta Kilit Pr. / Middle Lock Profile	0,941 kg/mt	1.5

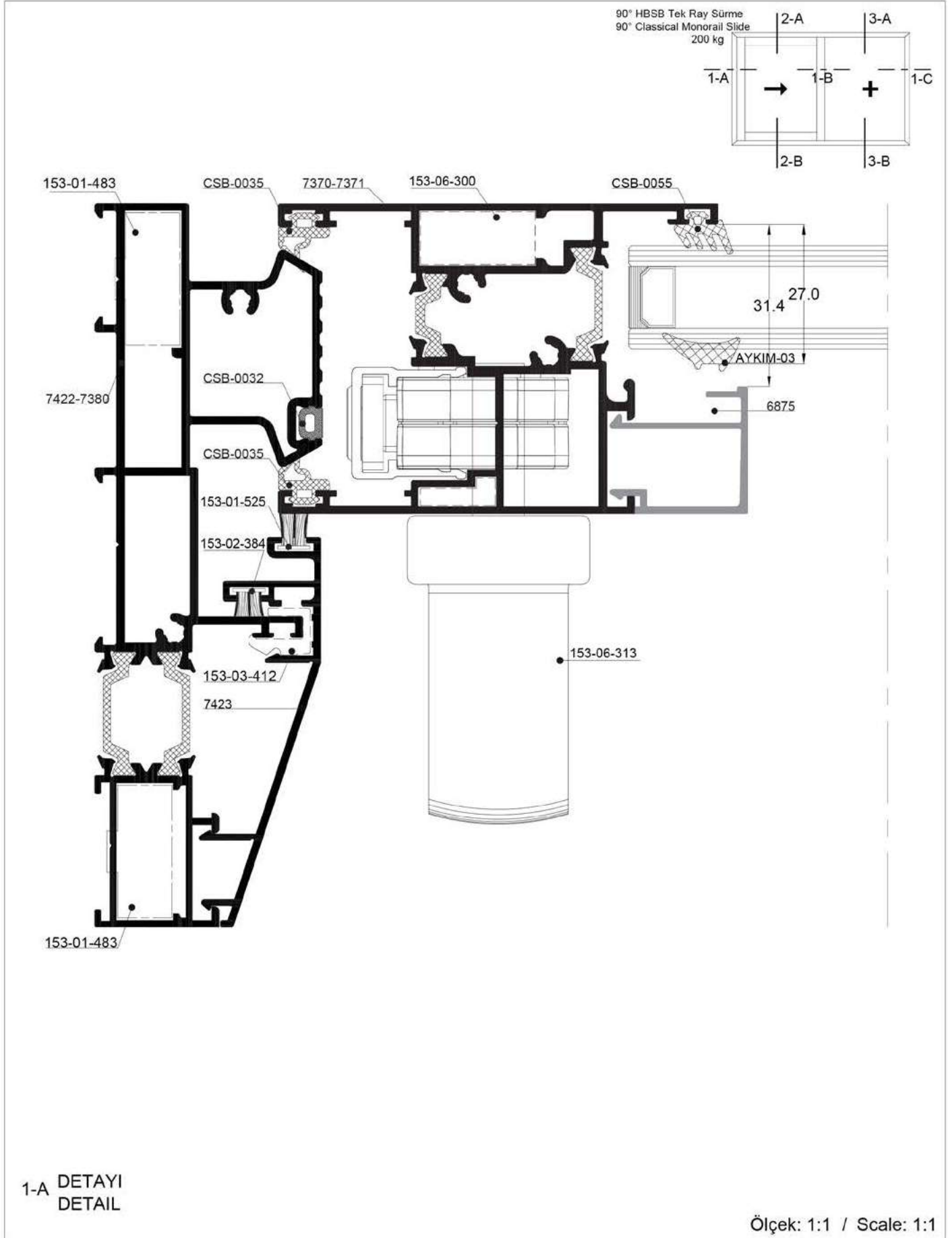

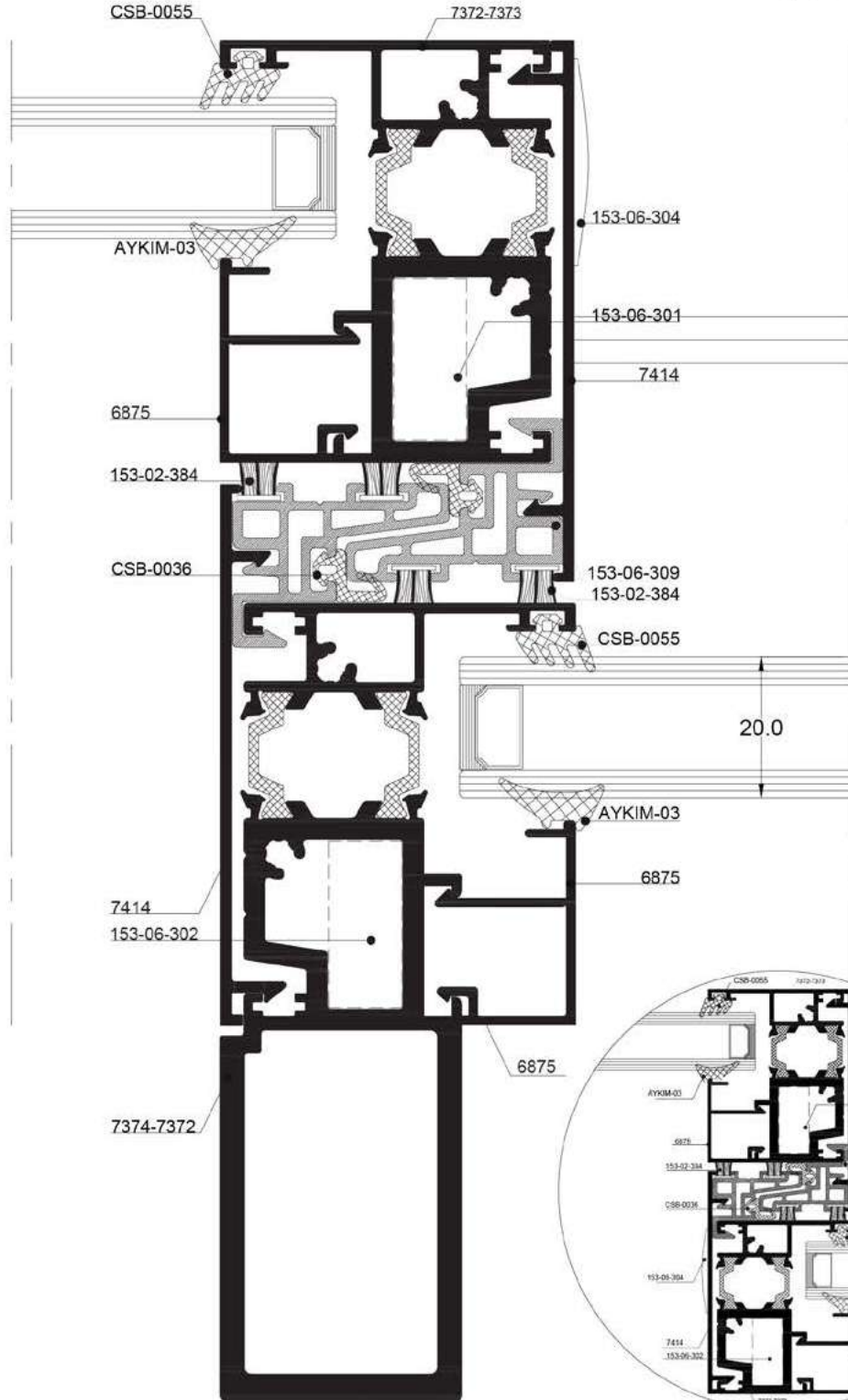
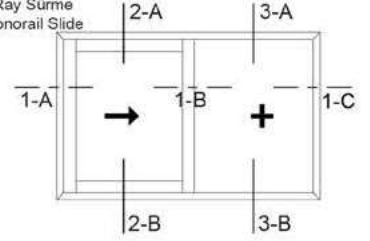
90° HBSB Tek Ray Sürme
90° Classical Monorail Slide1-B DETAYI
DETAIL

Ölçek: 1:1 / Scale: 1:1

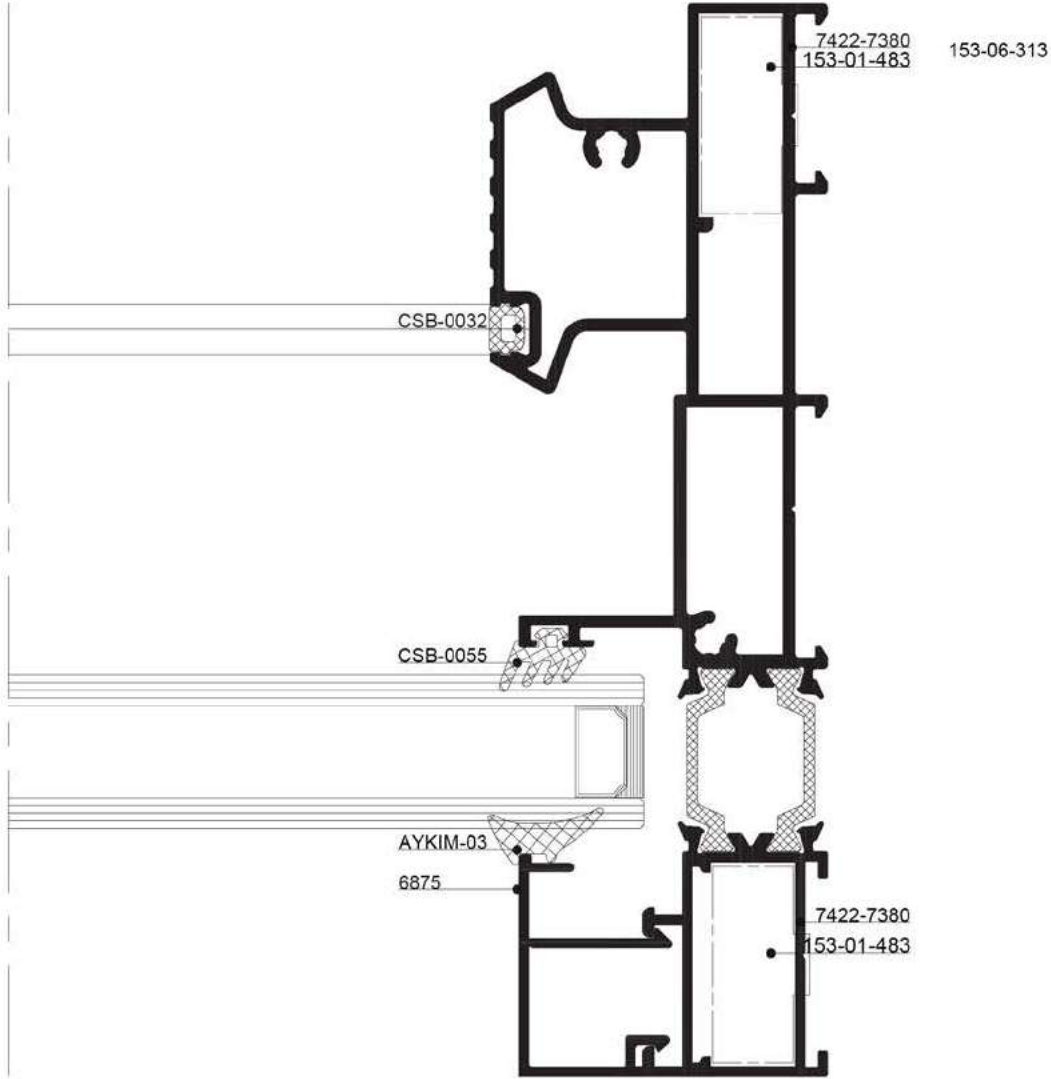
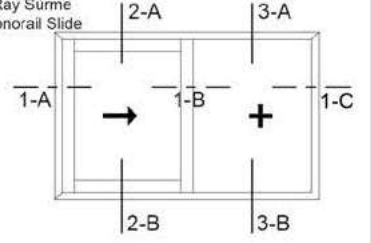
90° HBSB Tek Ray Sürme
 90° Classical Monorail Slide

 1-C DETAYI
 DETAIL

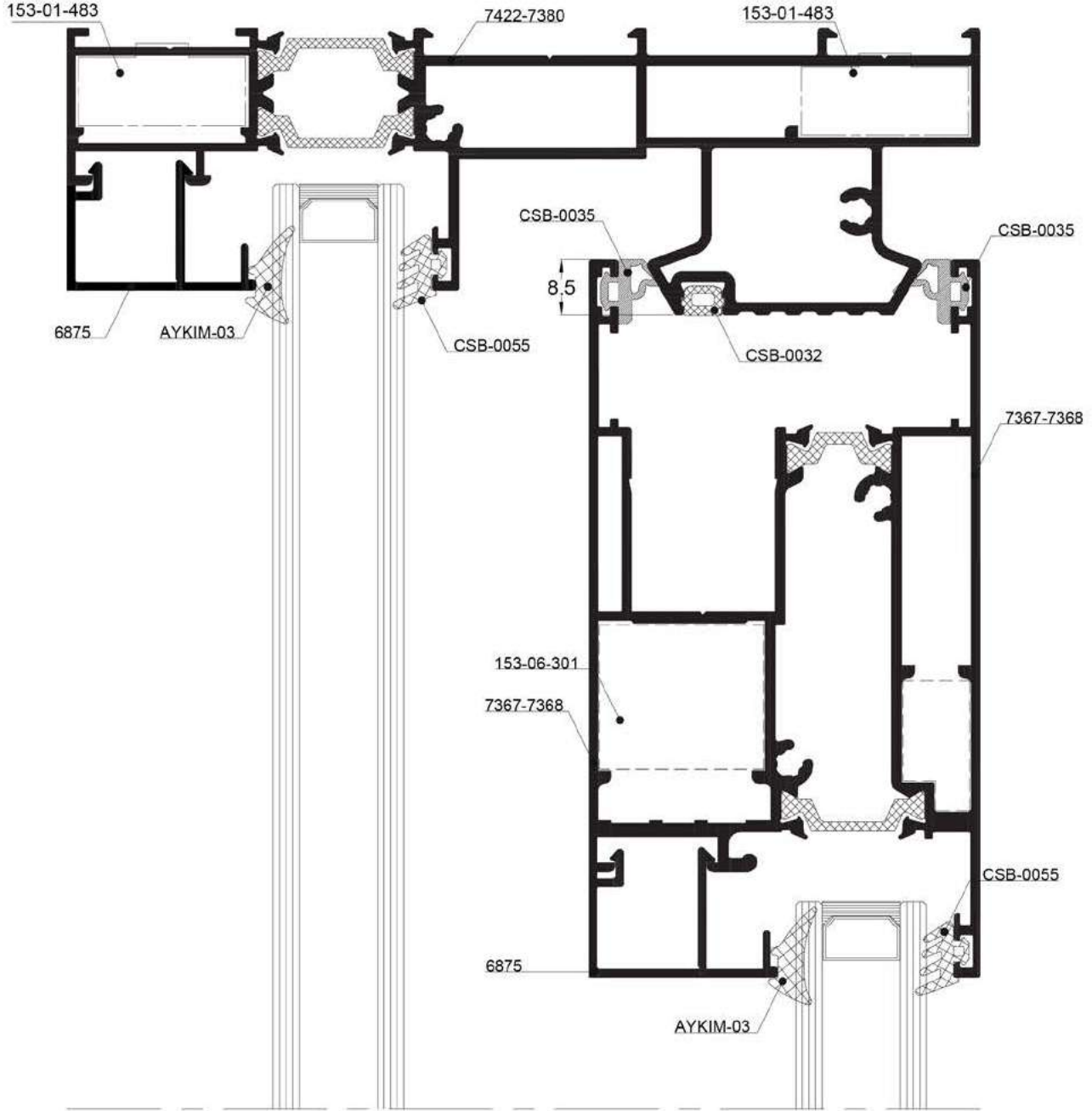
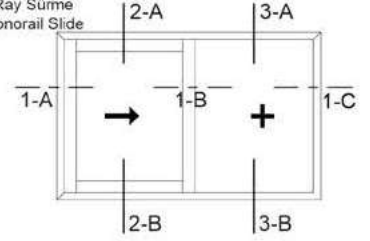
Ölçek: 1:1 / Scale: 1:1

90° HBSB Tek Ray Süme
90° Classical Monorail Slide3-A DETAYI
DETAIL

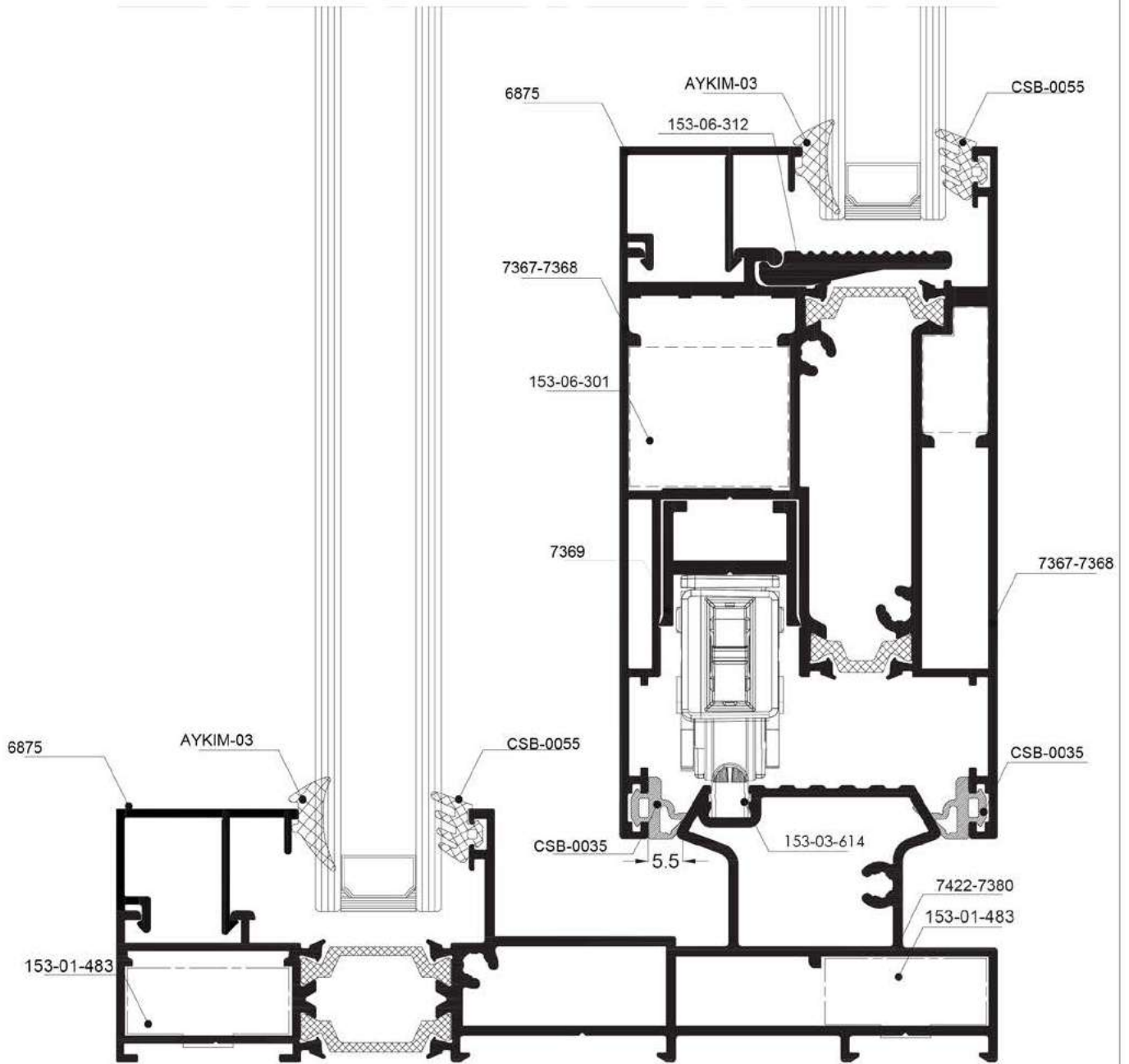
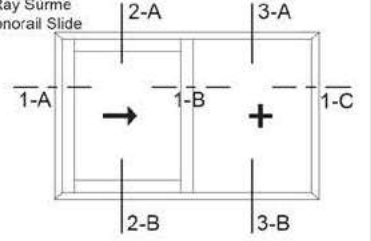
Ölçek: 1:1 / Scale: 1:1

90° HBSB Tek Ray Sürme
 90° Classical Monorail Slide

 3-B DETAYI
 DETAIL

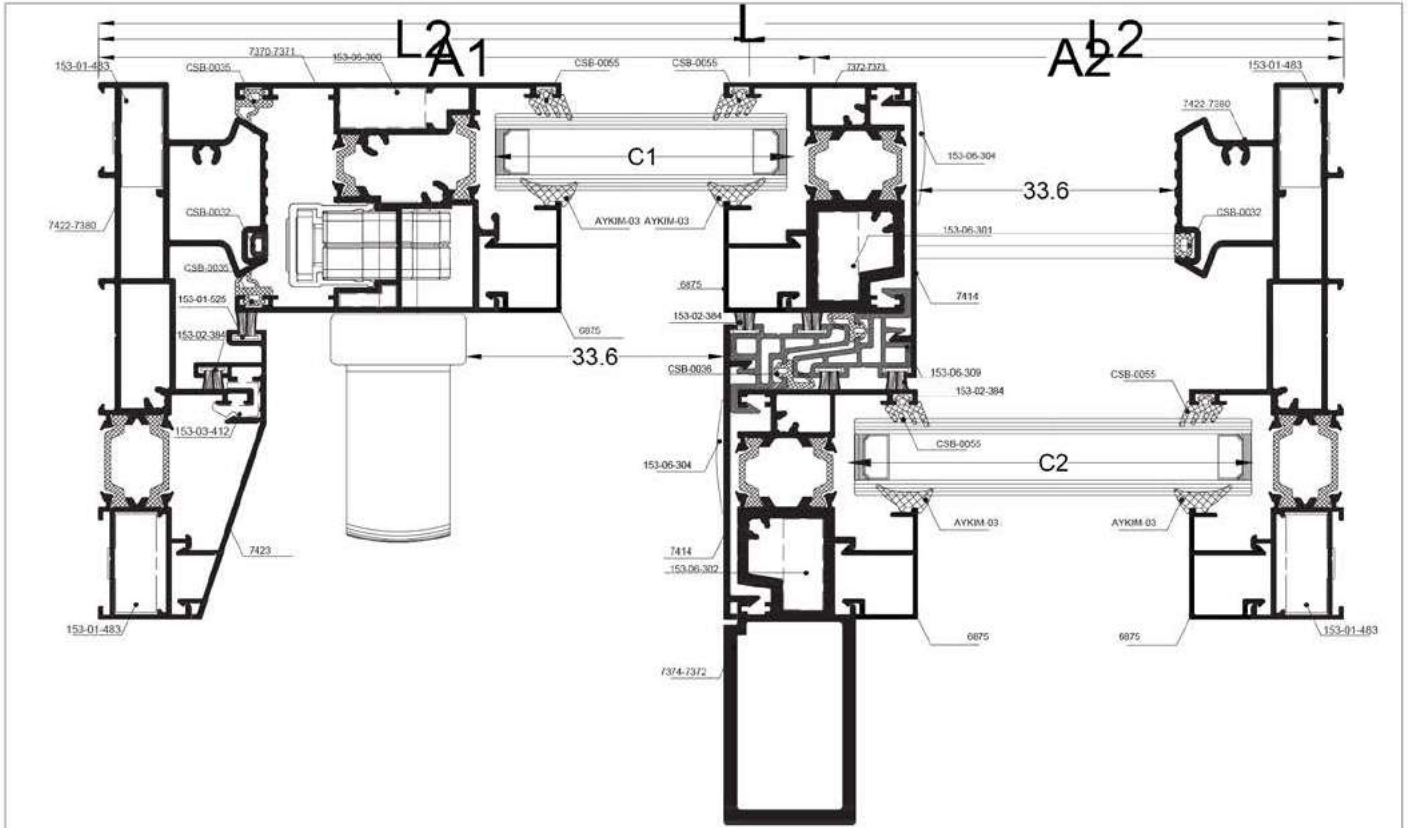
Ölçek: 1:1 / Scale: 1:1





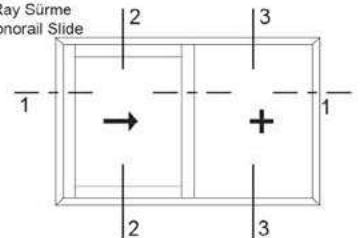

















Kasa Genişlik Frame Width	7422-7380			
Kasa Yükseklik Frame Height	7422-7380			
Kilit Kanat Yükseklik Sash Height	7370-7371			
Yatay Kanat Genişlik Horizontal Sash Width	7367-7368			
Kenet Kanat Yükseklik Sash Height	7374-7372			
Orta Kayıt Yükseklik Middle Transon Height	7372-7373			
Adaptör Profili Yükseklik Adapter Profile Height	7414			
Adaptör Profili Genişlik Adapter Profile Width	7424			
Çıta Profil Genişlik Glazing Bead Profile Width	6875			
Çıta Profil Yükseklik Glazing Bead Profile Height	6875			
Adaptör Profili Yükseklik Adapter Profile Height	7423			
Adaptör Profili Genişlik Adapter Profile Width	7369			
Kanat Cam Genişlik Glazing Sash Width				
Kanat Cam Yükseklik Glazing Sash Height				
Sabit Cam Genişlik Fixed Glazing Width				
Sabit Cam Yükseklik Fixed Glazing Height				

90° Klasik Tek Ray Sürme
90° Classical Monorail Slide



Çizimler 1/2 Ölçeklidir.

Kesim ölçüsü - cam ölçüsü vb. sorumluluğu tarafımıza ait değildir.

	153-01-483 Vidalalı Köşe Bağ. Takozu Screwed Corner Cleat	8 Ad. 8 Pcs.		153-06-314 Kasa Alt & Üst Tozluk (monoray) Central Top & Bottom Sealing	1Tkm. 1Set
	153-06-300 90° Geniş Köşe Bağlantı 90° Wide Sash Cor Joint	2 Ad. 2 Pcs.		153-06-305 Stoplama Stoppage	2 Ad. 2 Pcs.
	153-06-301 90° Dar Köşe Bağlantı 90° Narrow Sash Cor Joint	2 Ad. 2 Pcs.		153-02-384 67-550'lik Kumaş Finli Kıl Fitiil Brush Pile Seal	5H+1L
	153-06-302 90° Orta Kayıt Bağlantı 90° Center Joint	1 Tkm. 1 Set		153-01-525 67-700'lük Kumaş Finli Kıl Fitiil Brush Pile Seal	1H+1L
	153-06-312 Cam Altı Destek. Takozu Glass Support	30 cm ara ile kullanılacak		CSB-0032 Ray Kapama Contası Gasket For Frame Rails	2H+1L
	153-03-412 Kapak Klipsi Plastic Lock Clips	30cm ara ile kullanılacak.		AYKIM-04 Glazing Wedge Gasket (Cam Tercihine Göre) (Optional Glass Size)	2C1+2C1'+ 2C2+2C2'
	153-06-309 Kanat Kenetleme Plastikliği Plastic Sash Lock Adapter	Metre Meter (H-71) 2 Ad.		CSB-0055 Dış Cam Contası External Glass Gasket	2C2+2C2 2C1'+2C1
	153-06-304 Adaptör Kapağı Alt & Üst Adapter Cap Bottom & Top	2 Tkm. 2 Set		CSB-0035 HBSB Kanat Bini Fitiili Sash Holder Wick	2H+2L
	153-03-614 Paslanmaz Çelik Ray Stainless Steel Rail Track	L-75,8 mm. 1 Ad./Pcs.		CSB-0036 HBSB Kenet Plastikliği Fitiili Sash Lock Wick	2H
	153-03-406 90° Kertmeli Kulup Kapak 90° Notched Sash End Cap	1 Tkm. 1 Set.			

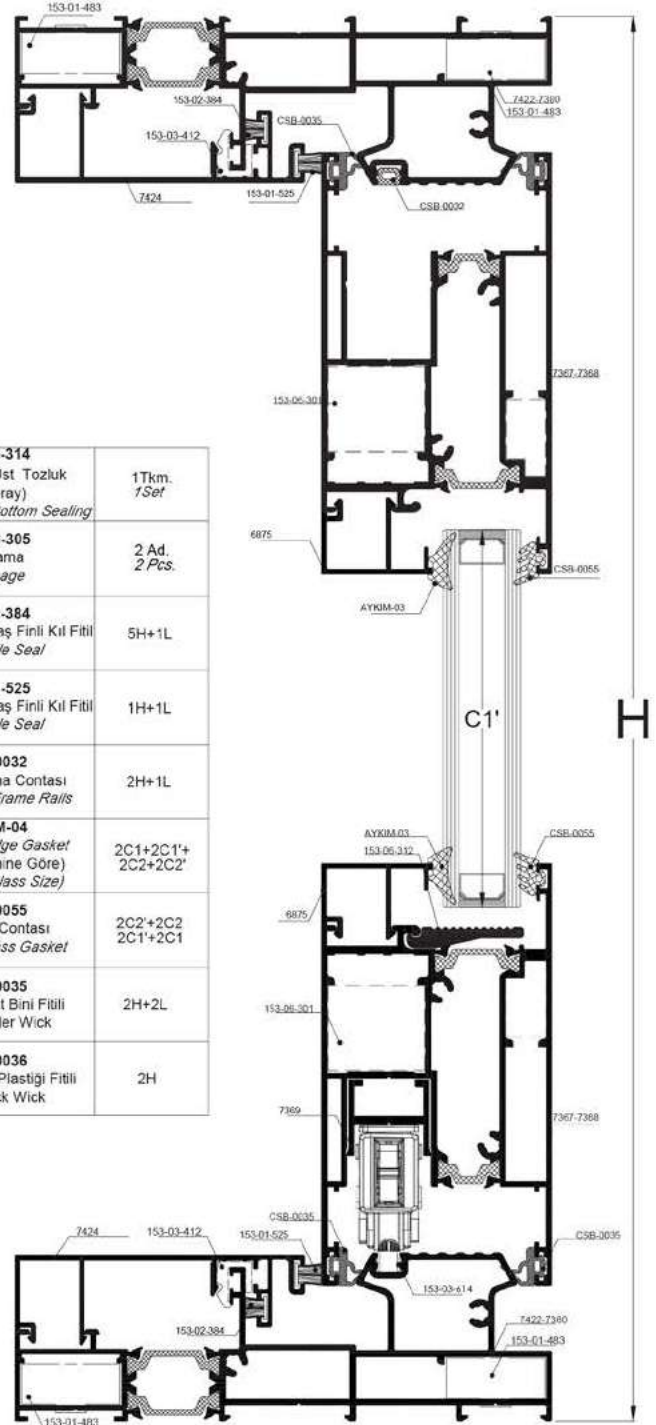
 2-2
 DETAYI
 DETAIL

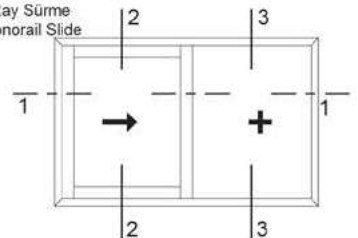
 90° Klasik Tek Ray Sürme
 90° Classical Monorail Slide

Kesim ölçüsü - cam ölçüsü vb. sorumluluğu tarafımıza ait değildir.

Çizimler 1/2 Ölçeklidir.

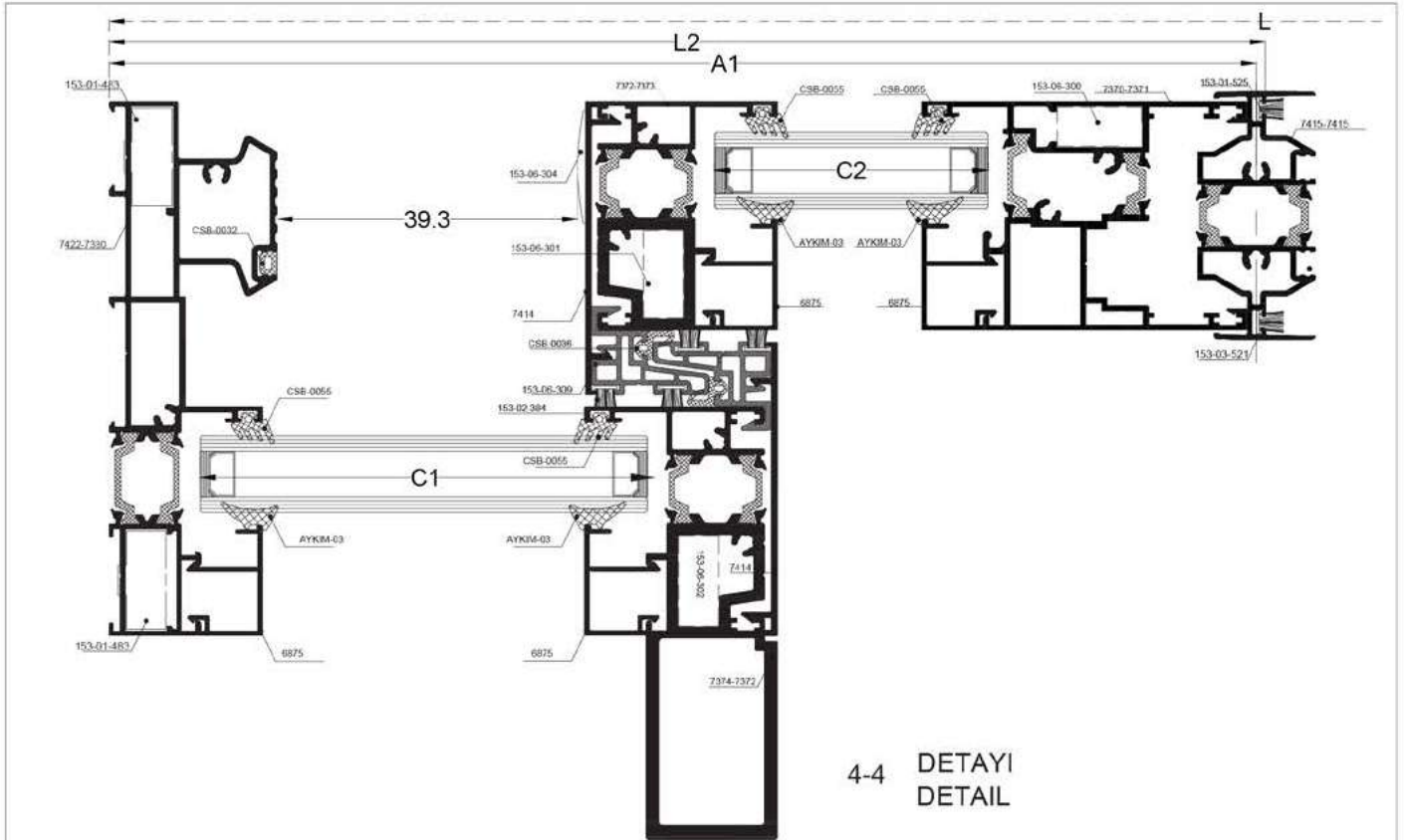

Kasa Genişlik Frame Width	082Y-082Y				L
Kasa Yükseklik Frame Height	082Y-1308Y				H
Kanat Yükseklik Sash Height	7370-7371				
Yatay Kanat Genişlik Horizontal Sash Width	7367-7368				
Kenet Kanat Yükseklik Sash Height	7374-7372				
Kenet Kanat Yükseklik Sash Height	7372-7373				
Orta Kilit Middle Lock	7415-7415				
Adaptör Profil Yükseklik Adapter Profile Height	7414				
Çıta Profil Genişlik Glazing Bead Profile Width	6875				
Çıta Profil Yükseklik Glazing Bead Profile Height	6875				
Adaptör Profil Genişlik Adapter Profile Width	7369				
Kanat Cam Genişlik Glazing Sash Width					
Kanat Cam Yükseklik Glazing Sash Height					
Sabit Cam Genişlik Glazing Sash Width					
Sabit Cam Yükseklik Glazing Sash Height					

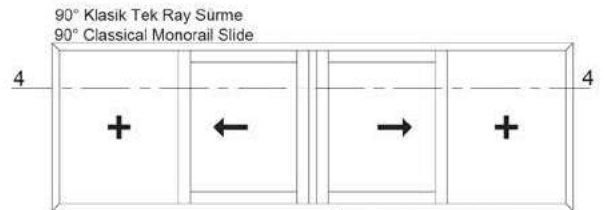

Ölçek: 1:2 / Scale: 1:2

Kesim ölçüsü - cam ölçüsü vb. sorumluluğu tarafımıza ait değildir.

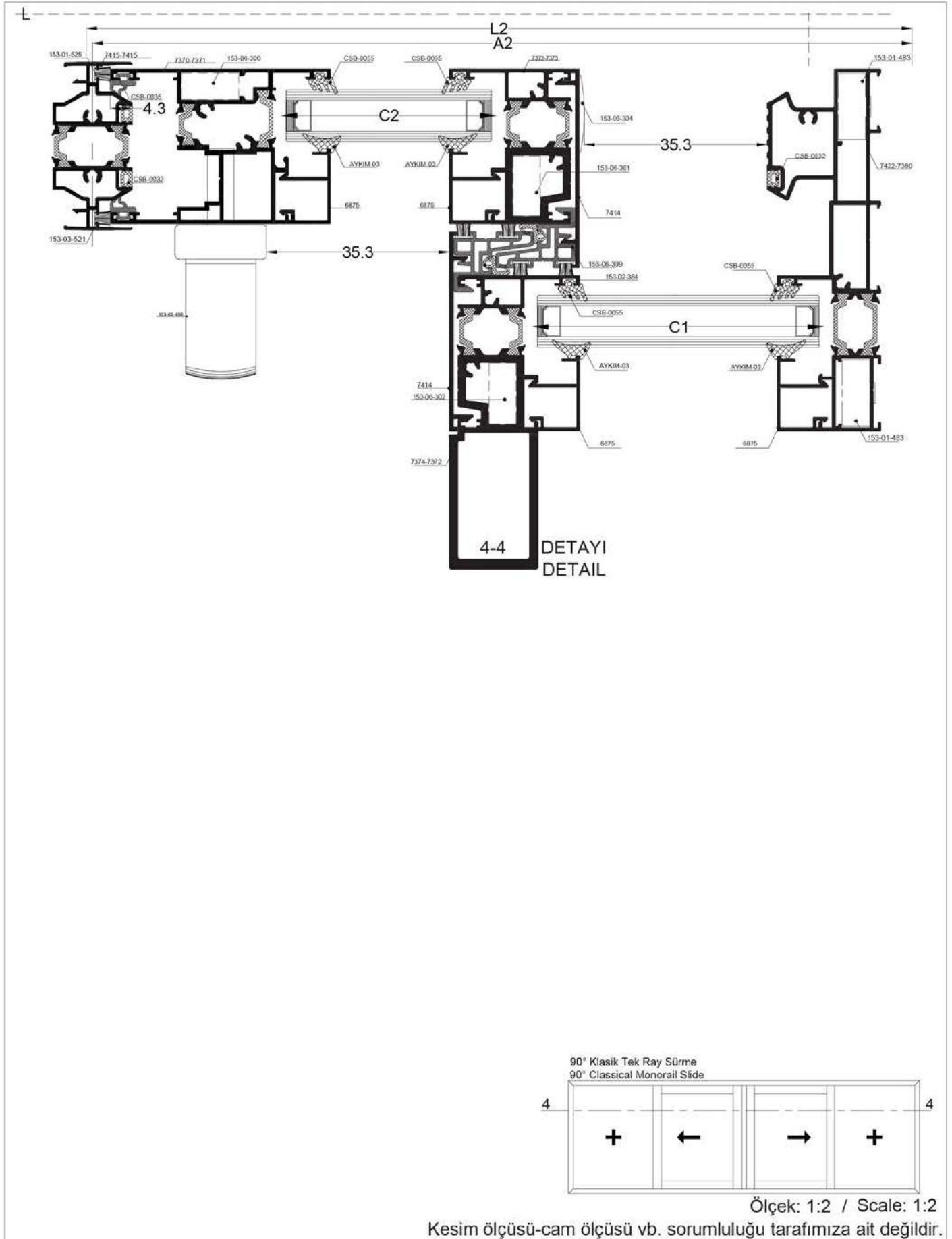

90° Klasik Sürme

90° Classical Slide

6-A

5-A

5-B

5-C

6-B

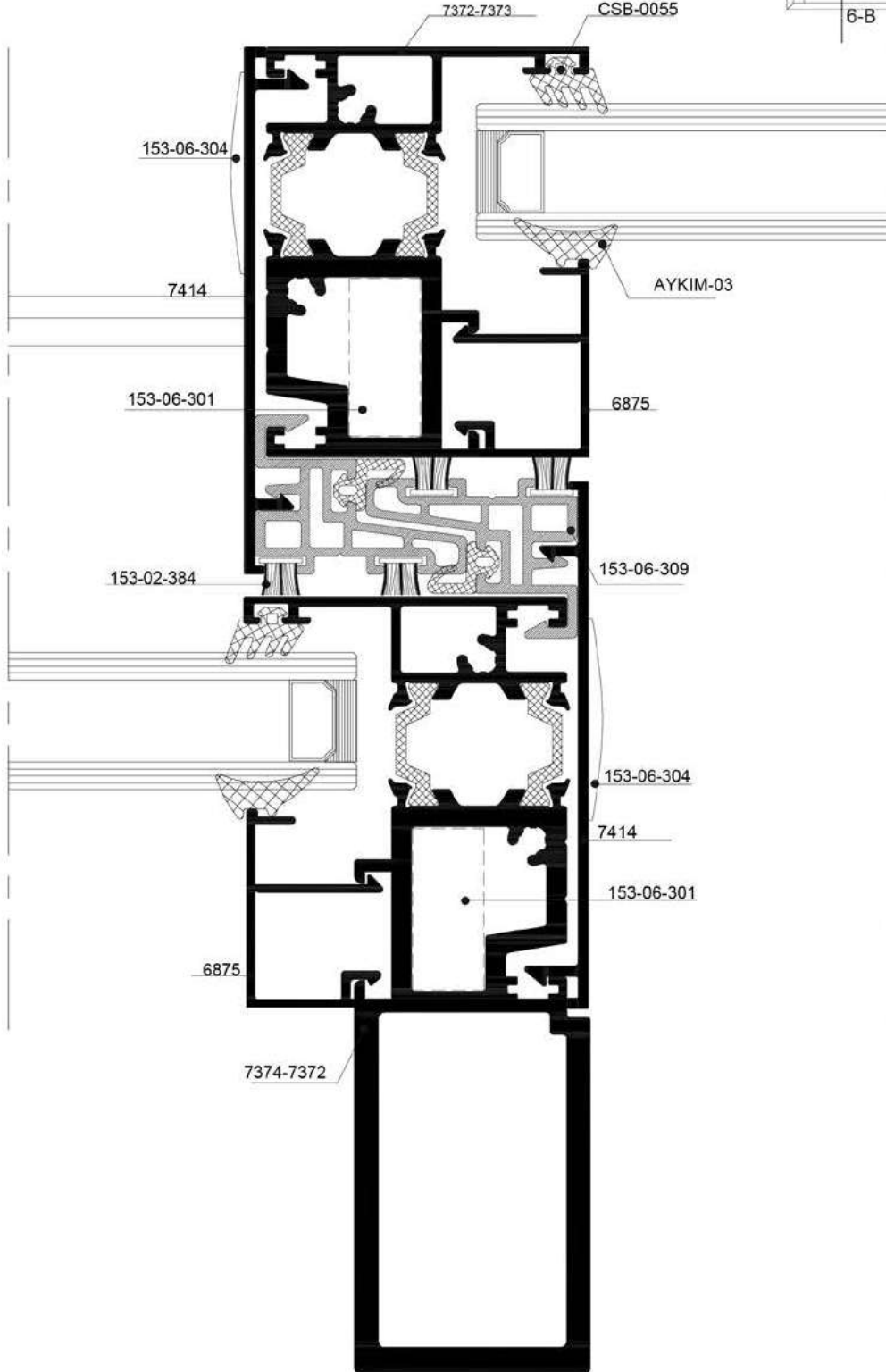
5-B DETAYI
DETAIL

Ölçek: 1:1 / Scale: 1:1

90° Klasik Sürme

90° Classical Slide

6-A

5-A

5-B

5-C

6-B

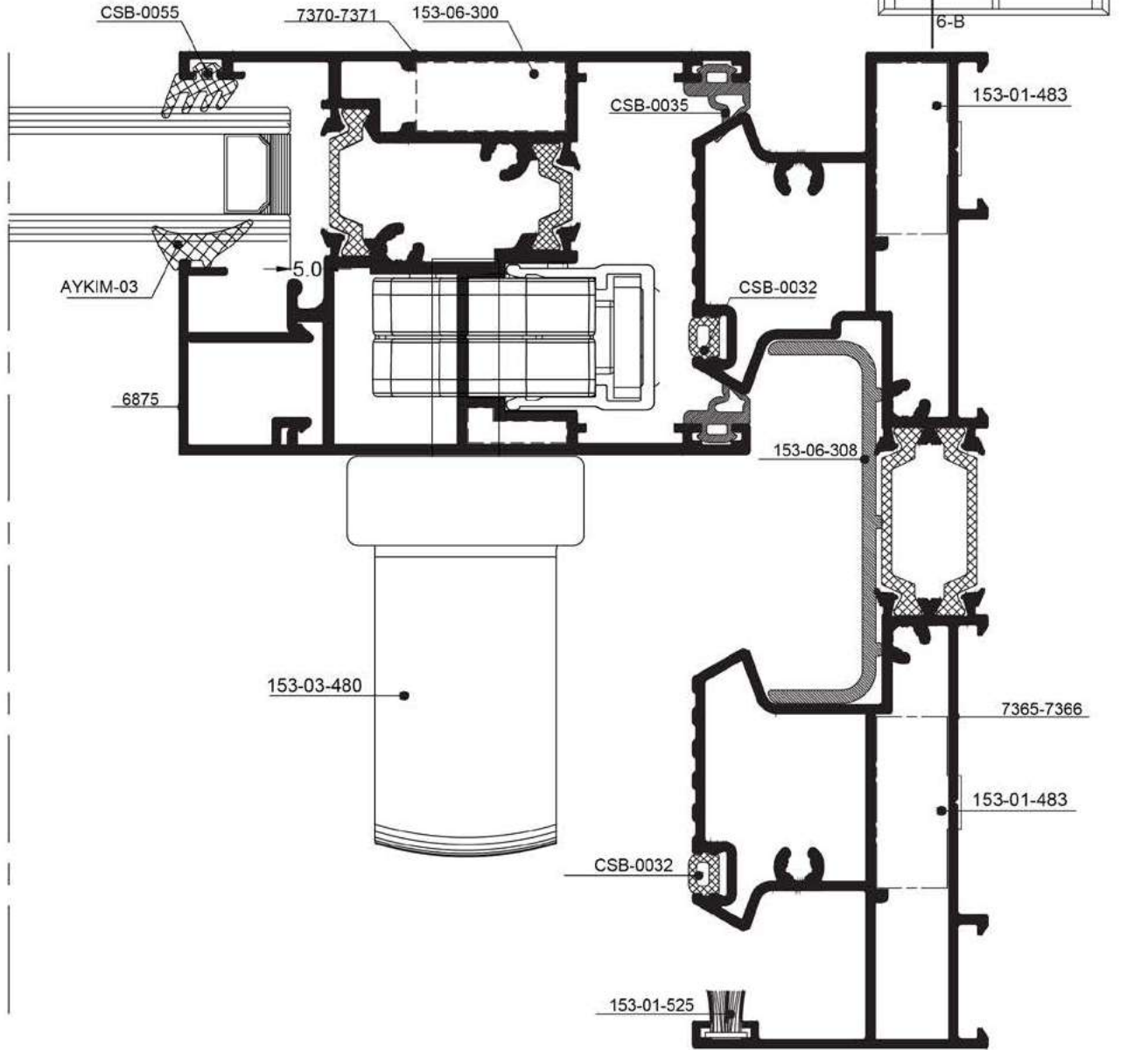
 5-C
 DETAYI
 DETAIL

Ölçek: 1:1 / Scale: 1:1

90° Klasik Süme

90° Classical Slide

6-A

5-A

5-B

5-C

6-B

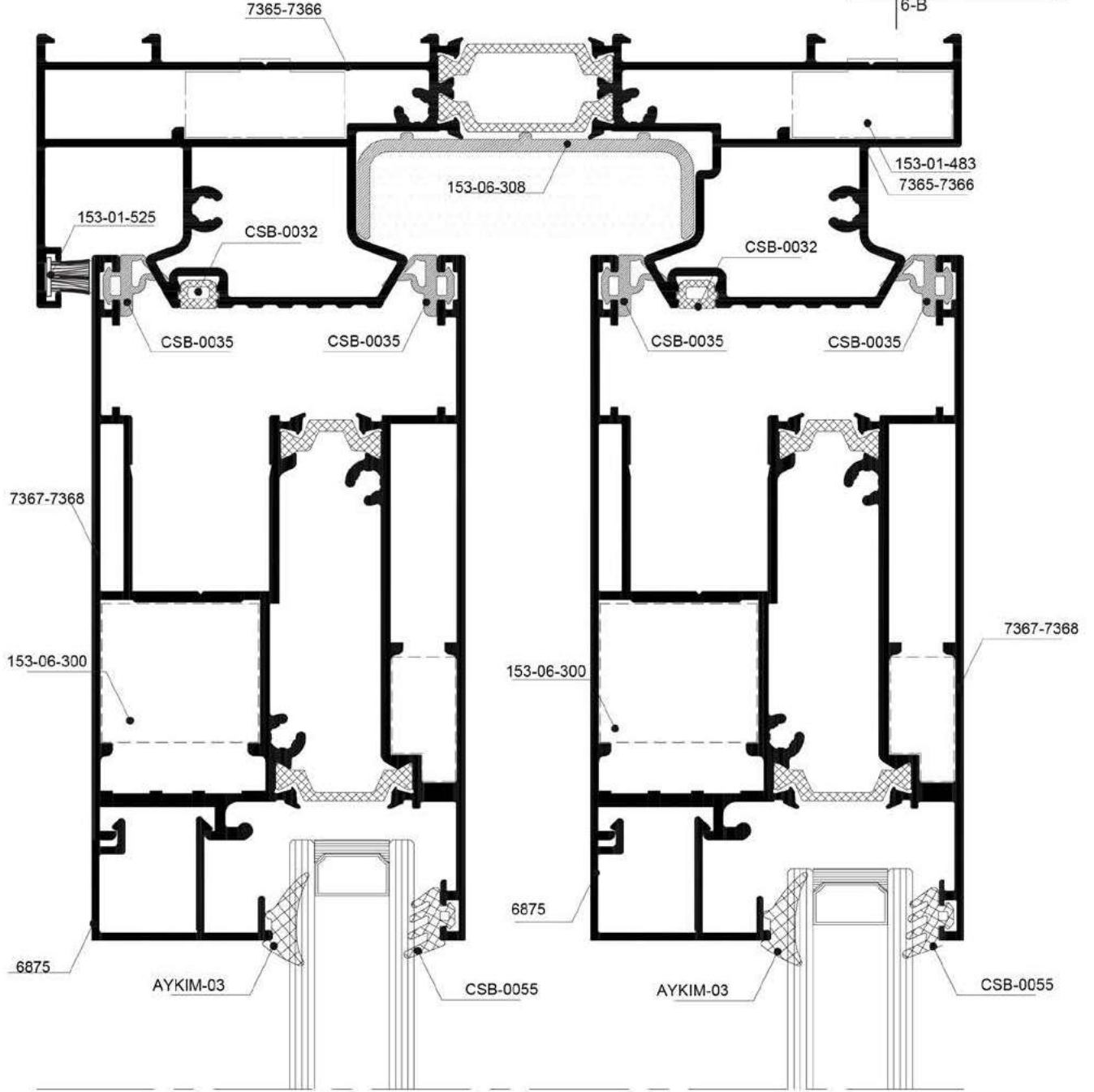
6-A DETAYI
DETAIL

Ölçek: 1:1 / Scale: 1:1

90° Klasik Sürme

90° Classical Slide

6-A

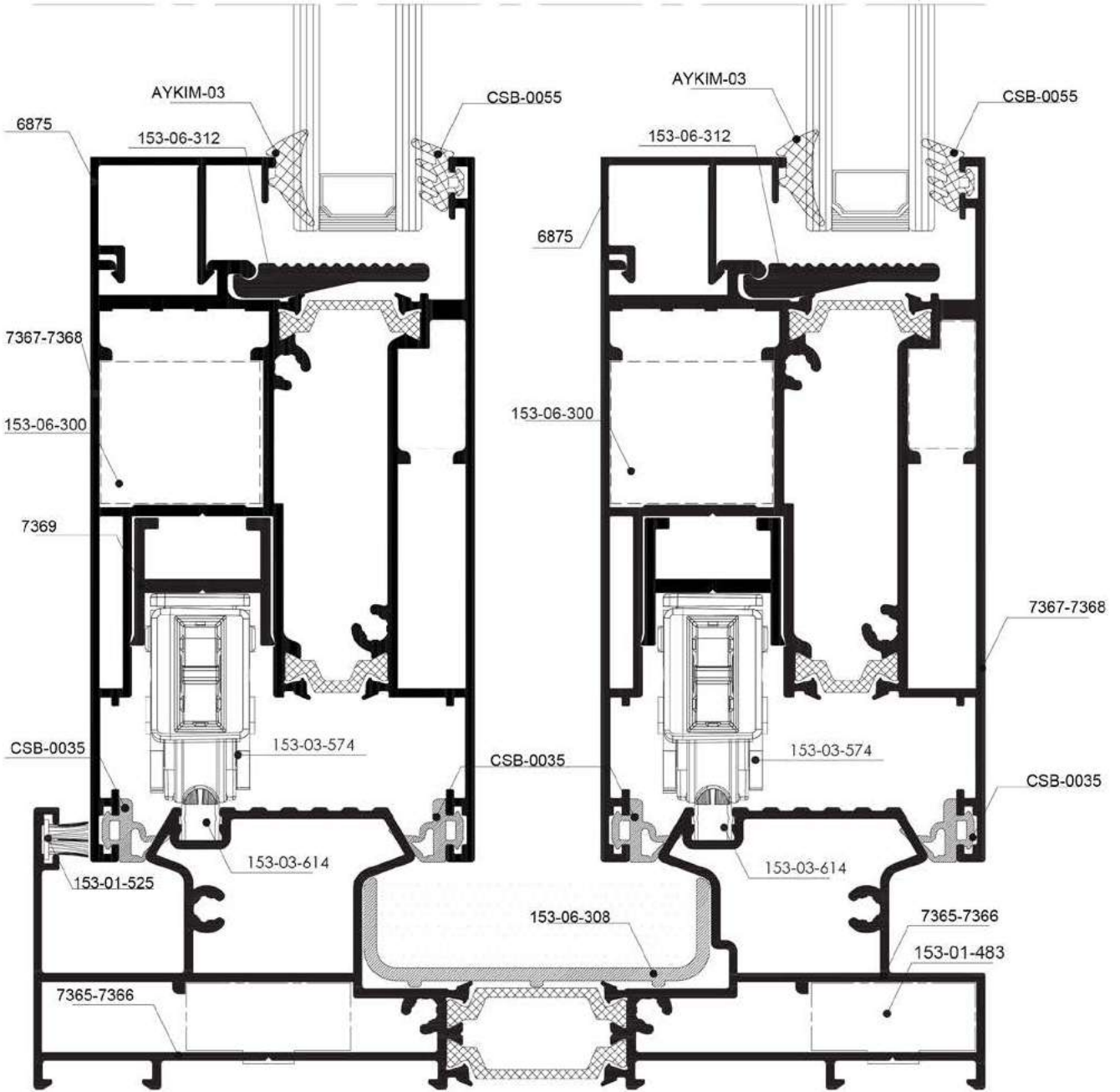
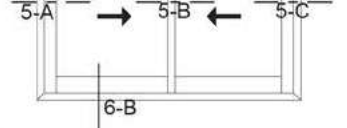
 6-B DETAYI
 DETAIL

Ölçek: 1:1 / Scale: 1:1

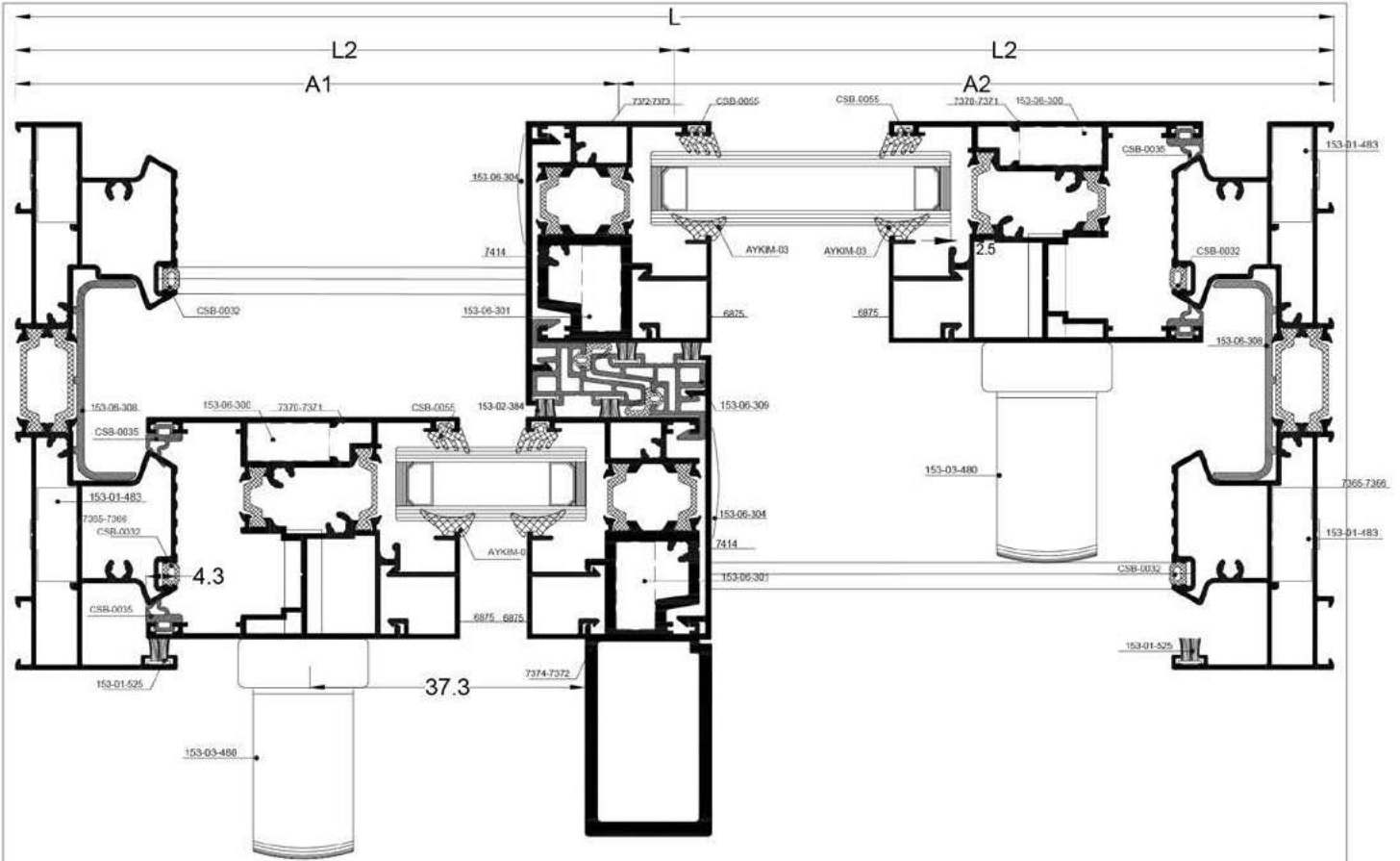



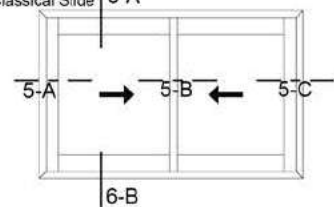



















	153-01-483 Vidalı Köşe Bağ Takozu Screwed Corner Cleat	8 Ad. 8 Pcs.		153-06-303 Kasa Alt & Üst Tozluk Central Top & Bottom Sealing	1Tkm. 1Set
	153-06-300 90° Geniş Köşe Bağlantı 90° Wide Sash Cor.Joint	2 Ad. 2 Pcs.		153-06-305 Stoplama Stoppage	2 Ad. 2 Pcs.
	153-06-301 90° Dar Köşe Bağlantı 90° Narrow Sash Cor.Joint	2 Ad. 2 Pcs.		153-02-384 67-550'lık Kumuş Fırlı Kil Fıtlı Brush Pile Seal	5H+2L
	153-06-312 Cam Altı Destek Takozu Glass Support	1 Ad. 1 Pcs.		153-01-525 67-700'lık Kumuş Fırlı Kil Fıtlı Brush Pile Seal	1H+3L
	153-03-424 Kanal "U" Plastikli Plastic Cover For Frame			CSB-0032 Ray Kapama Contası Gasket For Frame Rails	1H+1L
	153-03-412 Kapak Klipsi Plastic Lock Clips	30cm ara ile kullanılacak.		AYKİM-04 Glazing Wedge Gasket (Cam Terçhine Göre) (Optional Glass Size)	2C1+2C1'+ 2C2+2C2'
	153-06-309 Kanat Kenetleme Plastikli Plastic Sash Lock Adapter	Metre Meter (H-70) 2 Ad.		CSB-0055 Dış Cam Contası External Glass Gasket	2C2+2C2 2C1'+2C1
	153-06-304 Adaptör Kapak: Alt & Üst Adapter Cap Bottom & Top	2 Tkm. 2 Set		CSB-0035 Kanat Bini Fıtlı Sash Holder Wick	2H+4L
	153-03-630 Paslanmaz Çelik Ray Stainless Steel Rail Track	L-75.8 mm. 1 Ad./Pcs.		CSB-0036 HBSB Kenet Plastikli Fıtlı Sash Lock Wick	2H
	153-03-406 90° Keçmeli Kulüp Kapak 90° Notched Sash End Cap	1 Tkm. 1 Set			

90° Klasik Sürme
90° Classical Slide

Çizimler 1/2 Ölçeklidir.

5-5 DETAYI
DETAIL

Kesim ölçüsü - cam ölçüsü vb. sorumluluğu tarafımıza ait değildir.

Kasa Genişlik Frame Width	7365-7366				L
Kasa Yükseklik Frame Height	7365-7366				H
Kanat Yükseklik Sash Height	7370-7371				
Yatay Kanat Genişlik Horizontal Sash Width	7367-7368				
Kenet Kanat Yükseklik Sash Height	7374-7372				
Kenet Kanat Yükseklik Sash Height	7372-7373				
Adaptör Profili Yükseklik Adapter Profile Height	7414				
Çita Profili Genişlik Glazing Bead Profile Width	6875				
Çita Profili Yükseklik Glazing Bead Profile Height	6875				
Adaptör Profili Genişlik Adapter Profile Width	7369				
Kanat Cam Genişlik Glazing Sash Width					
Kanat Cam Yükseklik Glazing Sash Height					

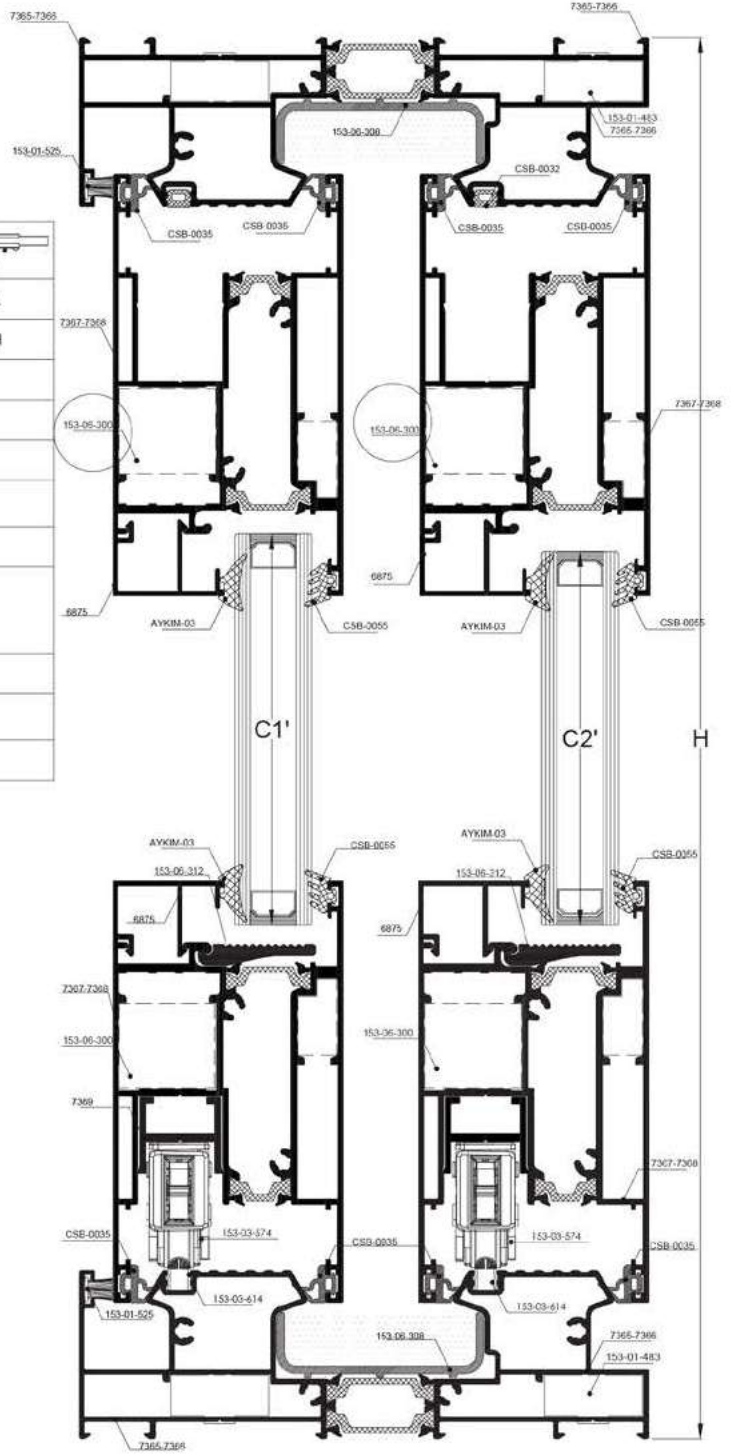
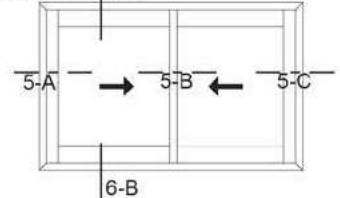

 90° Klasik Sürme
 90° Classical Slide | 6-A

 6-6 DETAYI
 DETAIL

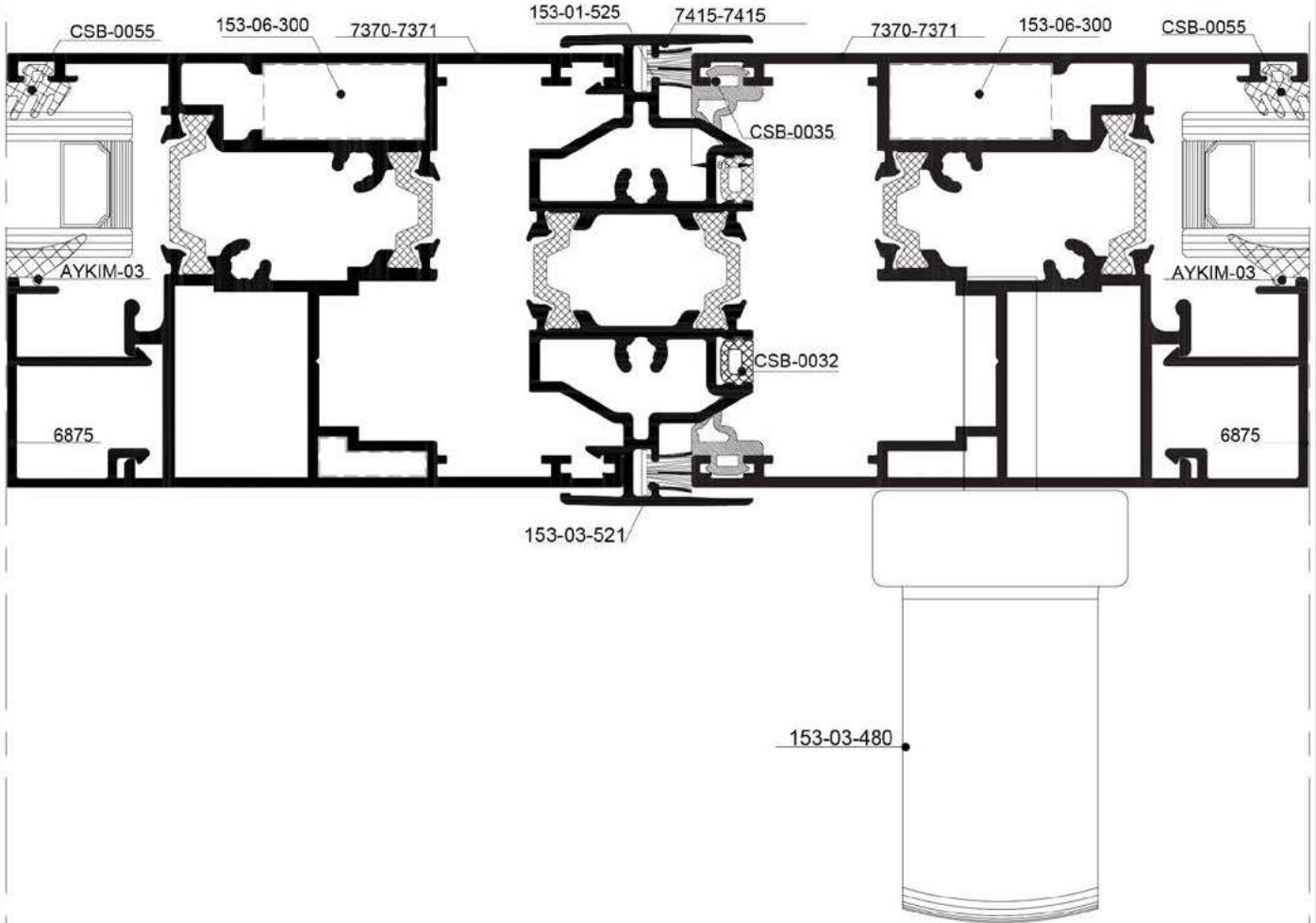
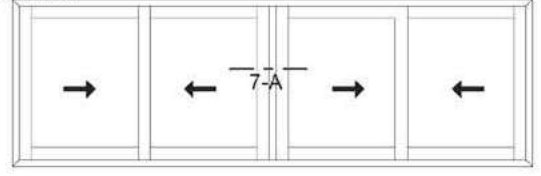
Kesim ölçüsü - cam ölçüsü vb. sorumluluğu tarafımıza ait değildir.

Çizimler 1/2 Ölçeklidir.

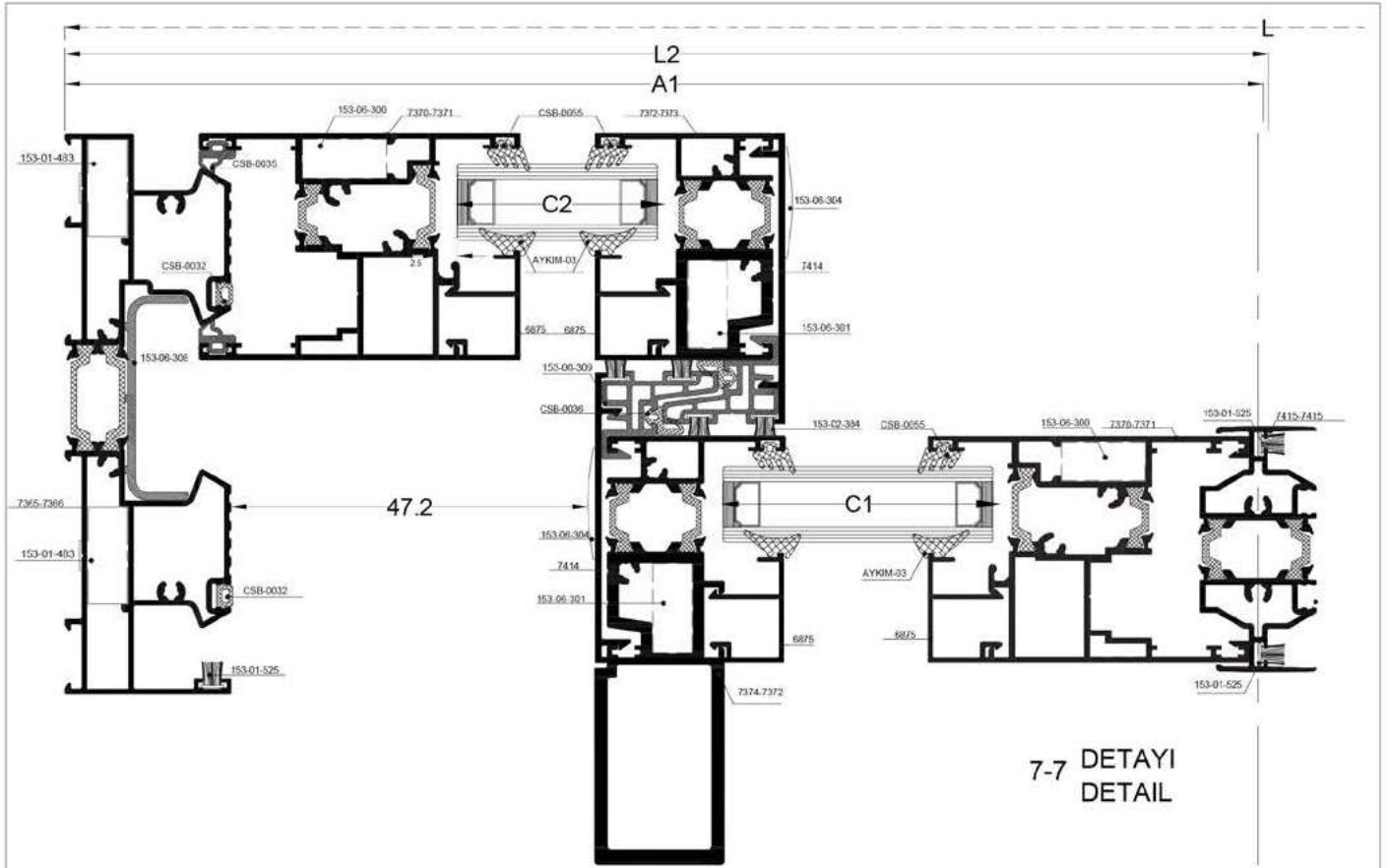
90° Klasik Sürme
90° Classical Slide7-A DETAYI
DETAIL

Ölçek: 1:1 / Scale: 1:1



Kasa Geniřlik Frame Width	7365-7366				L
Kasa Yüseklik Frame Height	7365-7366				H
Kanat Yüseklik Sash Height	7370-7371				
Yatay Kanat Geniřlik Horizontal Sash Width	7367-7368				
Kenet Kanat Yüseklik Sash Height	7374-7372				
Kenet Kanat Yüseklik Sash Height	7372-7373				
Orta Adaptör Middle Adapter	7415-7415				
Adaptör Profili Yüseklik Adapter Profile Height	7414				
Çıta Profili Geniřlik Glazing Bead Profile Width	6875				
Çıta Profili Yüseklik Glazing Bead Profile Height	6875				
Adaptör Profili Geniřlik Adapter Profile Width	7369				
Kanat Cam Geniřlik Glazing Sash Width					
Kanat Cam Yüseklik Glazing Sash Height					

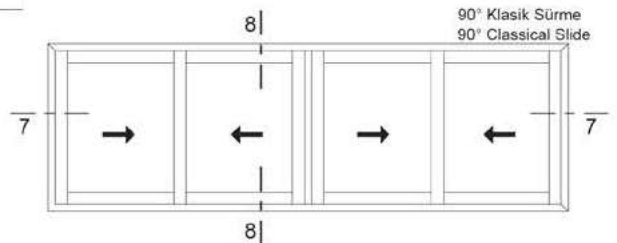



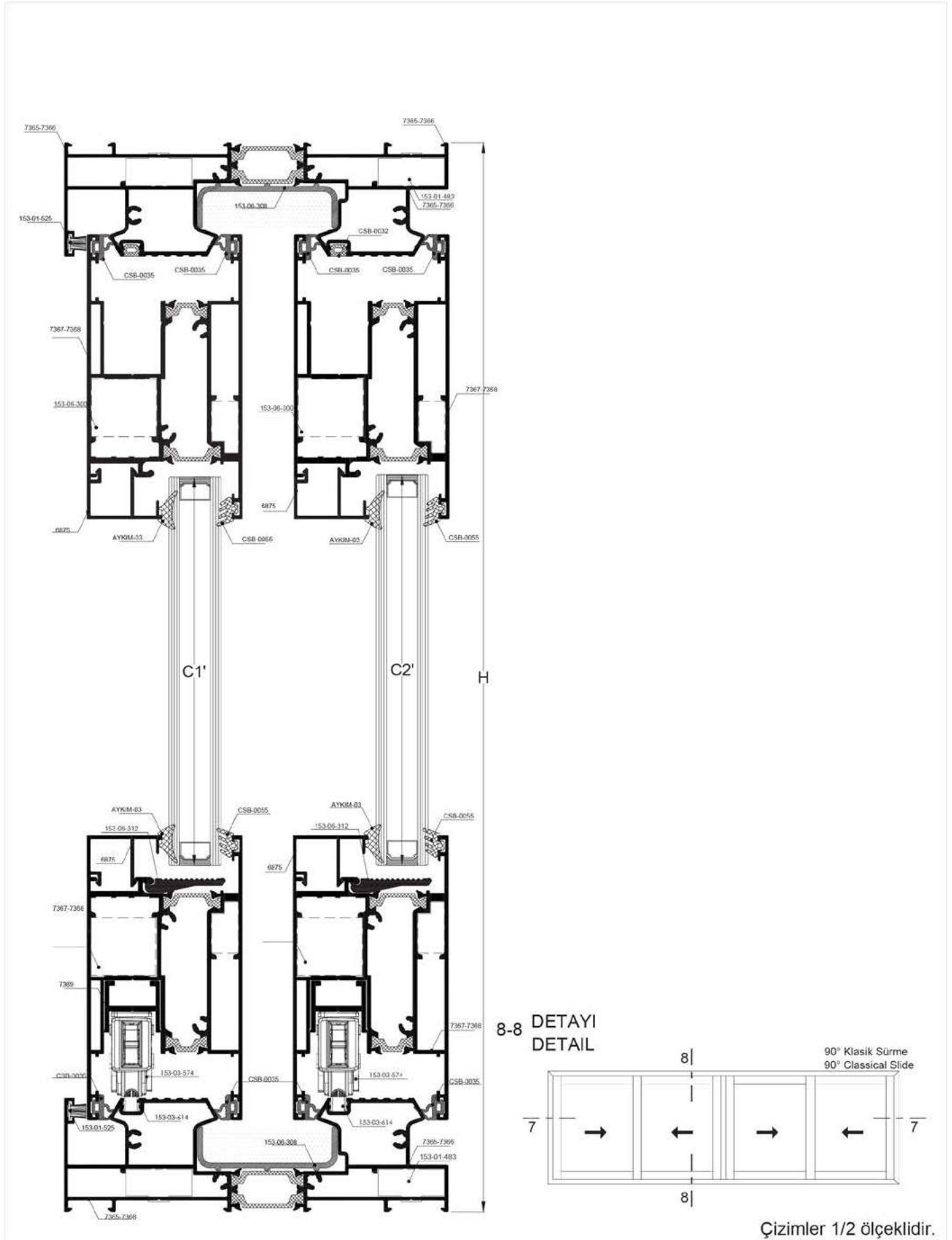



Çizimler 1/2 ölçeklidir.







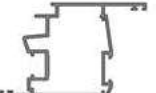
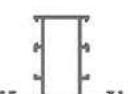
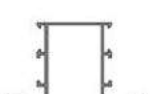

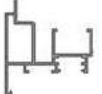
WD42

SD22
SD23
SD32
SD33
SD35
WD42
WD52
FS72

COSABELLA[®]
innovative aluminum solutions

Profil Profile	Profil Kodu Profile Nr	Ağırlık (kg/m.) Weight (kg/m.)	X mm.	Y mm.	Jx cm ⁴	Jy cm ⁴
	7090 Pencere Kasa Pr. Window Frame Pr.	0,928kg/mt	53,5 mm	57,4 mm	14,61	6,93
	7092 Kapı Kasa Pr. Door Frame Pr.	1,040kg/mt	53,5 mm	70 mm	19,28	12,29
	7091 Pencere Kanat Pr. Window Sash Pr.	1,083kg/mt	60,5 mm	75 mm	24,15	7,52
	7093 Kapı Kanat Pr. Door Sash Pr.	1,325kg/mt	60,5 mm	96 mm	38,33	17,89
	7089 İspanyolet Pencere Kanat Pr. Espagnolette Window Sash Pr.	1,191kg/mt	60,5 mm	75 mm	24,63	7,16
	7098 İspanyolet Kapı Kanat Pr. Espagnolette Door Sash Pr.	1,373kg/mt	95,1 mm	60,5 mm	37,48	16,90
	7094 Orta Kayıt Pr. Middle Transom Pr.	1,032kg/mt	79,4 mm	53,5 mm	15,04	12,65
	7095 Orta Kayıt Pr. Middle Transom Pr.	1,159kg/mt	92,1 mm	53,5 mm	22,19	17,88
	7096 Baza Pr. Kick Plate Pr.	1,857kg/mt	135 mm	53,5 mm		
	7101 Orta Kayıt Pr. Middle Transom Pr.	1,976kg/mt	150 mm	53,5 mm		
	7097 Hareketli Orta Kayıt Pr.	1,018kg/mt	57,24 mm	69,2 mm	13,27	7,91

Profil Profile	Profil Kodu Profile Nr	Ağırlık (kg/m.) Weight (kg/m.)	X mm.	Y mm.	Jx cm ⁴	Jy cm ⁴
	7099 Baza Pr. Kick Plate Pr.	1,994,kg/mt	150 mm	53,5 mm		
	7077 Cam Çita Pr. Glazing Bead Pr.	0,280kg/mt	18,1 mm	26,61 mm		
	7086 Cam Çita Pr. Glazing Bead Pr.	0,294kg/mt	24,6 mm	26,61 mm		
	7087 Cam Çita Pr. Glazing Bead Pr.	0,304kg/mt	27,6 mm	26,61 mm		
	7088 Cam Çita Pr. Glazing Bead Pr.	0,320kg/mt	32,6 mm	26,61 mm		
	7100 Cam Çita Pr. Glazing Bead Pr.	0,288kg/mt	23,1 mm	26,61 mm		

Kasa Profili - Frame Pr.
 7090
 0,928 kg/mt

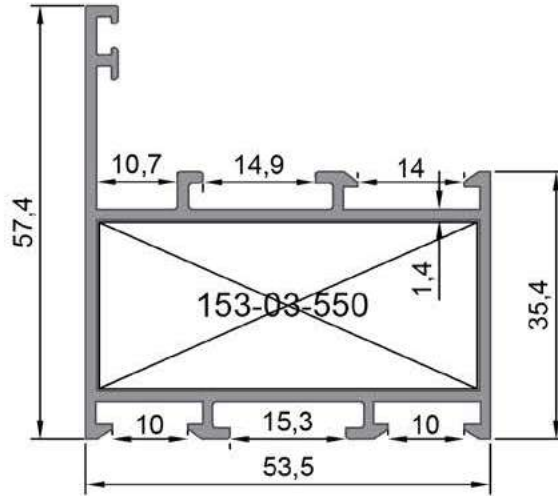

7090

Kod/Code	Et Kalın./Wall Thk.	Ürün Adı / Prod. Name	Ağırlığı / Weight	Köşe Takozu / C. Cleat
7090	1,4 mm	Kasa Profili - Frame Pr.	0,928 kg/mt	-

Kasa Profili - Frame Pr.
 7092
 1,040 kg/mt

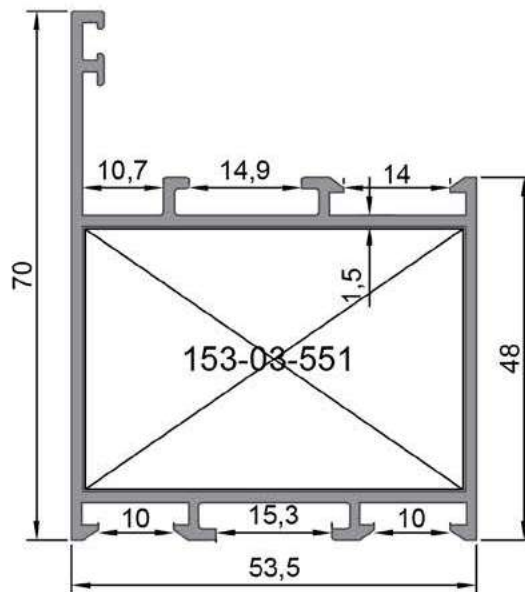

7092

Kod/Code	Et Kalın./Wall Thk.	Ürün Adı / Prod. Name	Ağırlığı / Weight	Köşe Takozu / C. Cleat
7092	1,5 mm	Kasa Profili - Frame Pr.	1,040 kg/mt	-

Pencere Kanat Profili - Window Sash Pr.

7091

1,083 kg/mt

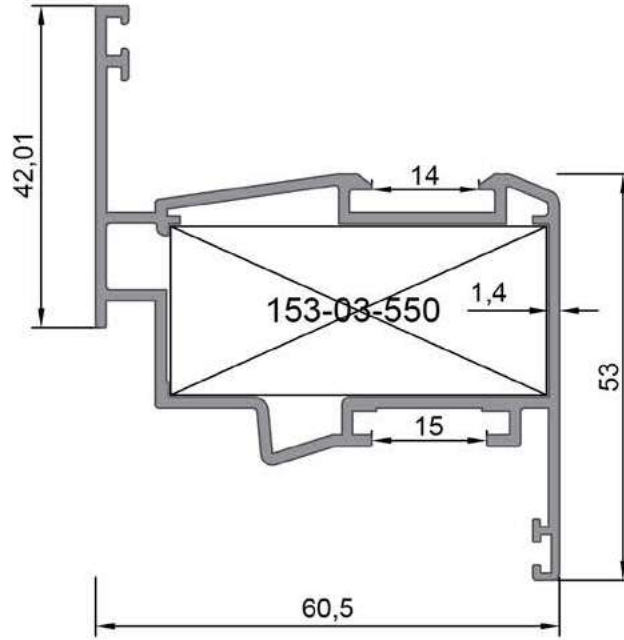

7091

Kod/Code	Et Kalın./Wall Thk.	Ürün Adı / Prod. Name	Ağırlığı / Weight	Köşe Takoğu / C. Cleat
7091	1,4 mm	Pencere Kanat Pr. / Window Sash Pr.	1,083 kg/mt	-

Kapı Kanat Profili - Door Sash Pr.

7093

1,325 kg/mt

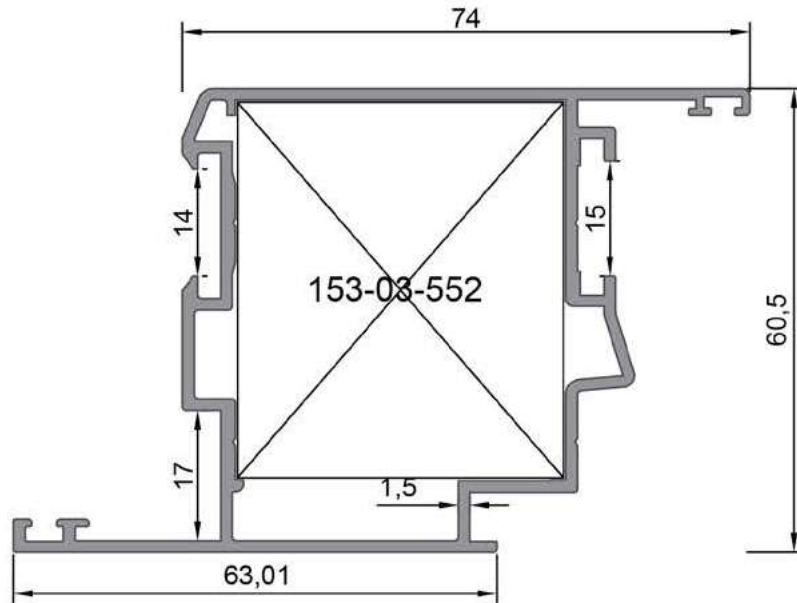

7093

Kod/Code	Et Kalın./Wall Thk.	Ürün Adı / Prod. Name	Ağırlığı / Weight	Köşe Takoğu / C. Cleat
7093	1,5 mm	Kapı Kanat Profili / Door Sash Pr.	1,325 kg/mt	-

İspanyolet Pencere Kanat Profili - Espagnolette Window Sash Pr.

7089

1,191 kg/mt

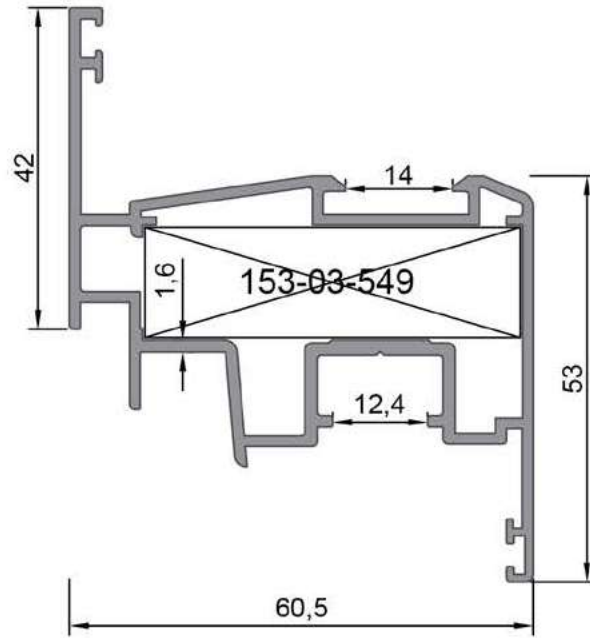

7089

Kod/Code	Et Kalın./Wall Thk.	Ürün Adı / Prod. Name	Ağırlığı /Weight	Köşe Takozu / C. Cleat
7089	1,6 mm	İspanyolet Pencere Kanat Pr. / Espagnolette Window Sash Pr.	1,191 kg/mt	-

İspanyolet Kapı Kanat Profili - Espagnolette Door Sash Pr.

7098

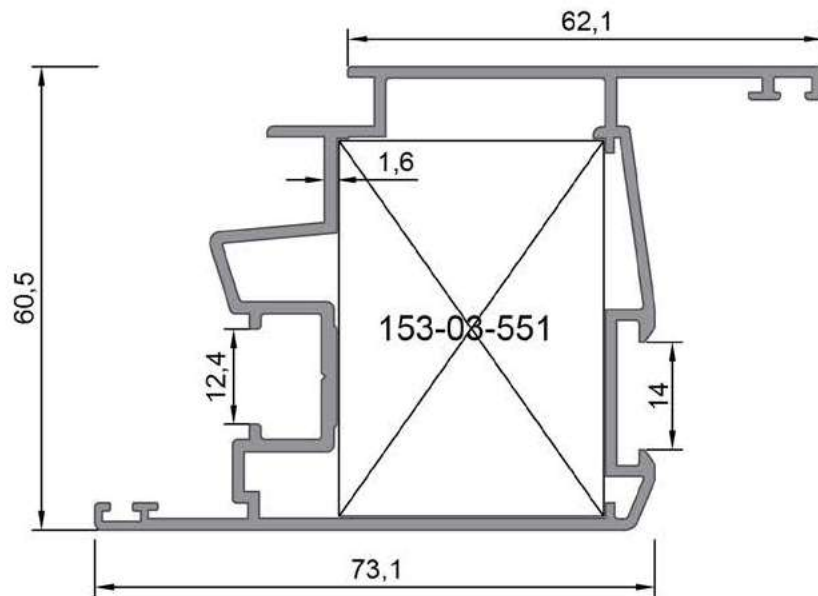
1,373 kg/mt



7098

Kod/Code	Et Kalın./Wall Thk.	Ürün Adı / Prod. Name	Ağırlığı /Weight	Köşe Takozu / C. Cleat
7098	1,6 mm	İspanyolet Kapı Kanat Profili - Espagnolette Door Sash Pr.	1,373 kg/mt	-

Pencere Orta Kayıt Profili - Window Middle Transom Profile

7094

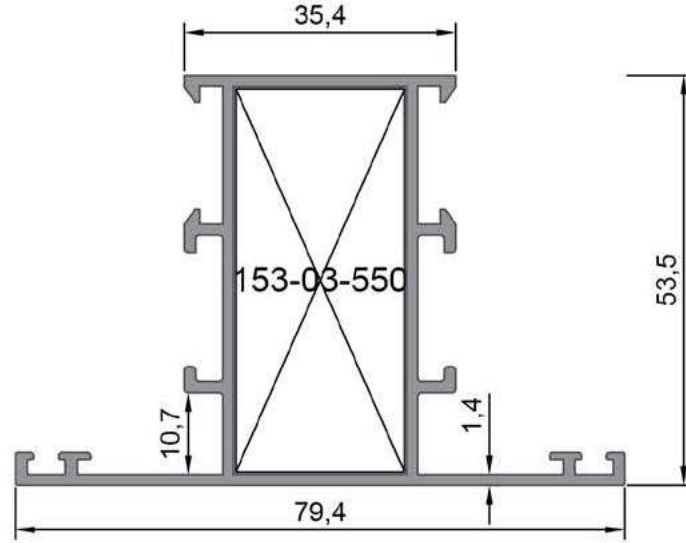
1,032 kg/mt



7094

Kod/Code	Et Kalın./Wall Thk.	Ürün Adı / Prod. Name	Ağırlığı / Weight	Köşe Takozu / C. Cleat
7094	1,4 mm	Pencere Orta Kayıt Pr. / Window Middle Transom Pr.	1,032 kg/mt	-

Kapı Orta Kayıt Profili - Door Middle Transom Profile

7095

1,159 kg/mt

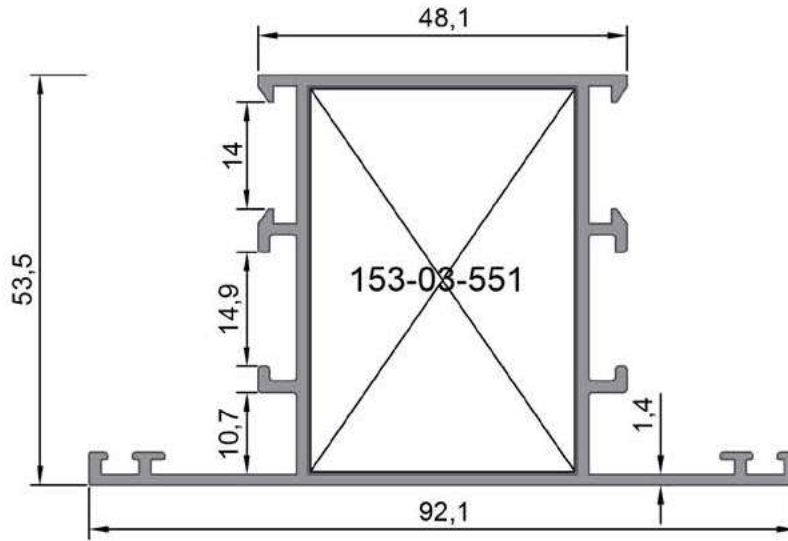

7095

Kod/Code	Et Kalın./Wall Thk.	Ürün Adı / Prod. Name	Ağırlığı / Weight	Köşe Takozu / C. Cleat
7095	1,4 mm	Kapı Orta Kayıt Pr. / Door Middle Transom Pr.	1,159 kg/mt	-

Baza Profili - Kick Plate Profile

7096

1,857 kg/mt

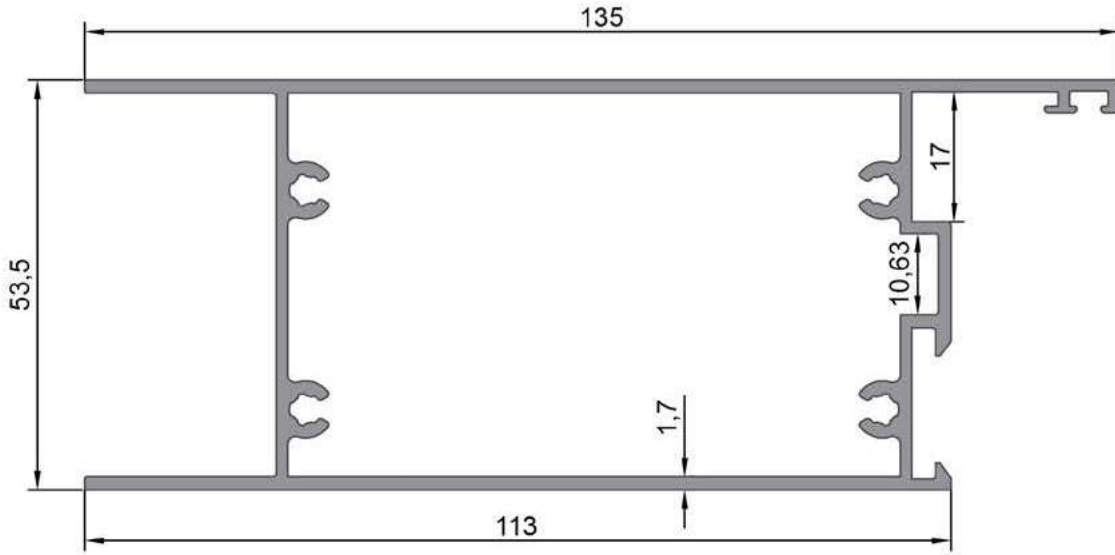
**7096**

Kod/Code	Et Kalın./Wall Thk.	Ürün Adı / Prod. Name	Ağırlığı / Weight	Köşe Takozu / C. Cleat
7096	1,7 mm	Baza Profili / Kick Plate Profile	1,857 kg/mt	-

Orta Kayıt Profili - Middle Transom Profile

7101

1,976 kg/mt

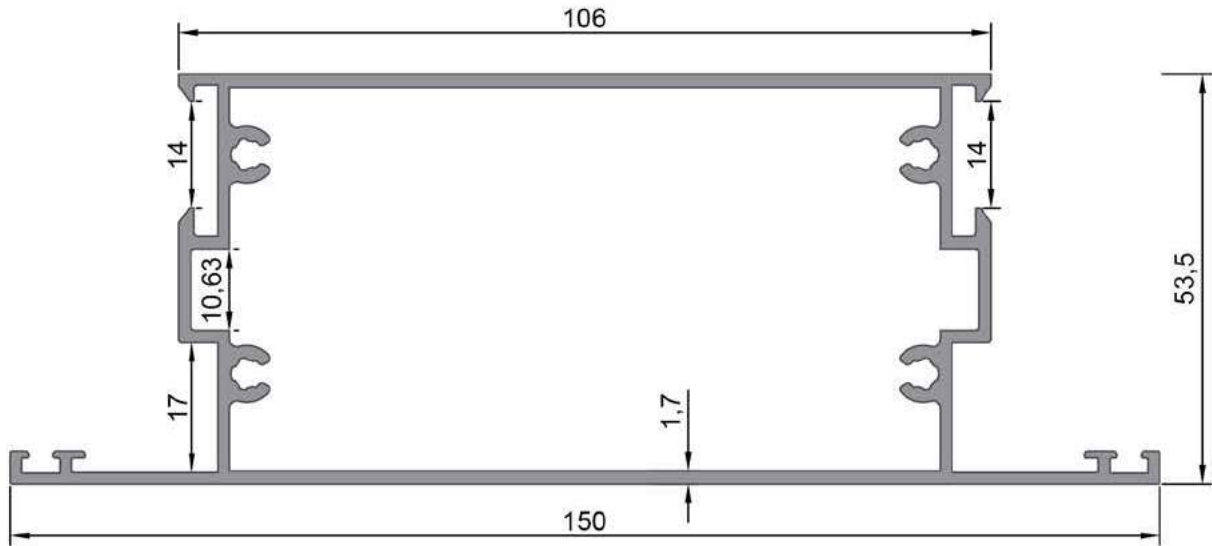
**7101**

Kod/Code	Et Kalın./Wall Thk.	Ürün Adı / Prod. Name	Ağırlığı / Weight	Köşe Takozu / C. Cleat
7101	1,7 mm	Orta Kayıt Profili / Middle Transom Pr.	1,976 kg/mt	-

Hareketli Orta Kayıt Profili

7097

1,018 kg/mt

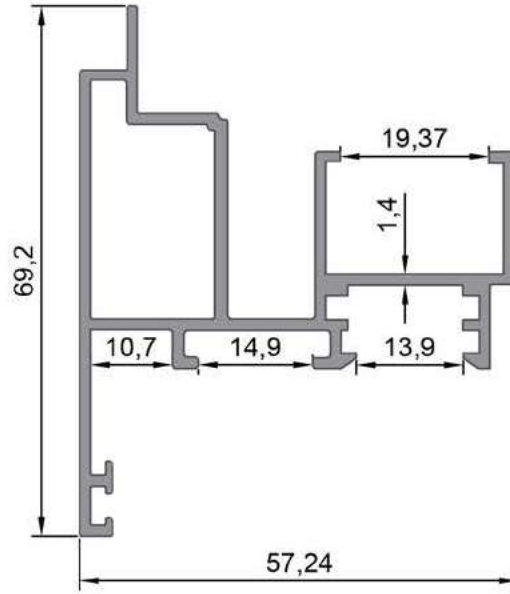

7097

Kod/Code	Et Kalın./Wall Thk.	Ürün Adı / Prod. Name	Ağırlığı / Weight	Köşe Takozu / C. Cleat
7097	1,4 mm	Orta Kayıt Pr. / Movable Middle Transom Pr.	1,018 kg/mt	-

Baza Profili - Kick Plate Profile

7099

1,994 kg/mt

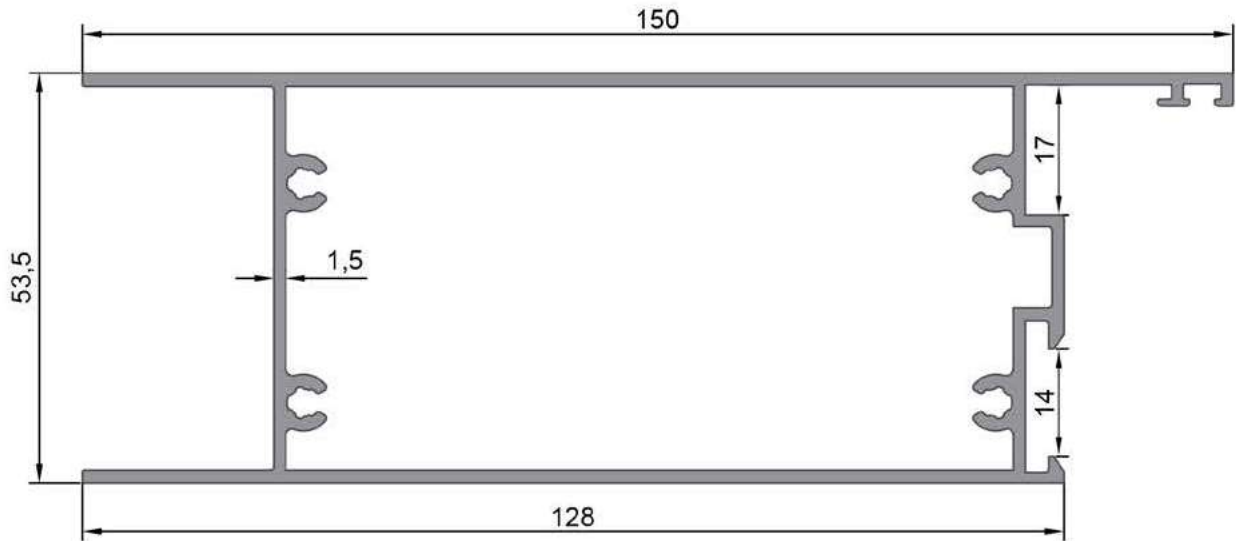

7099

Kod/Code	Et Kalın./Wall Thk.	Ürün Adı / Prod. Name	Ağırlığı / Weight	Köşe Takozu / C. Cleat
7099	1,5 mm	Baza Profili / Kick Plate Profile	1,994 kg/mt	-

Cam Çıta Pr. - Glazing Bead Pr.

7077

0,280 kg/mt

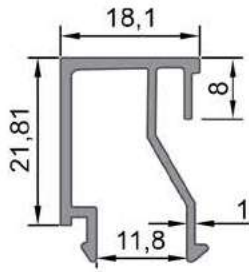
**7077**

Cam Çıta Pr. - Glazing Bead Pr.

7086

0,294 kg/mt

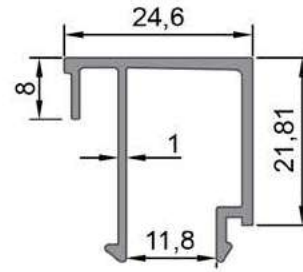
**7086**

Kod/Code	Et Kalın./Wall Thk.	Ürün Adı / Prod. Name	Ağırlığı / Weight	Köşe Takozu / C. Cleat
7077	1,0 mm	Cam Çıta / Glazing Bead Profile	0,280 kg/mt	-
7086	1,0 mm	Cam Çıta / Glazing Bead Profile	0,294 kg/mt	-

Cam Çıta Pr. - Glazing Bead Pr.

7087

0,304 kg/mt

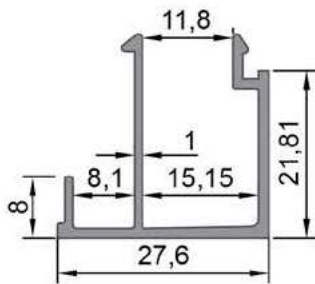
**7087**

Cam Çıta Pr. - Glazing Bead Pr.

7088

0,320 kg/mt

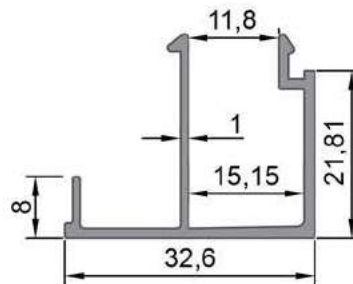
**7088**

Cam Çıta Pr. - Glazing Bead Pr.

7100

0,288 kg/mt

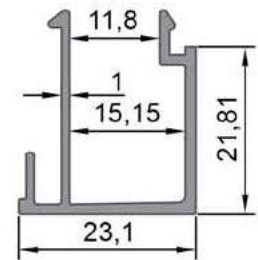
**7100**

Kod/Code	Et Kalın./Wall Thk.	Ürün Adı / Prod. Name	Ağırlığı / Weight	Köşe Takozu / C. Cleat
7087	1,0 mm	Cam Çıta / Glazing Bead Profile	0,304 kg/mt	-
7088	1,0 mm	Cam Çıta / Glazing Bead Profile	0,320 kg/mt	-
7100	1,0 mm	Cam Çıta / Glazing Bead Profile	0,288 kg/mt	-

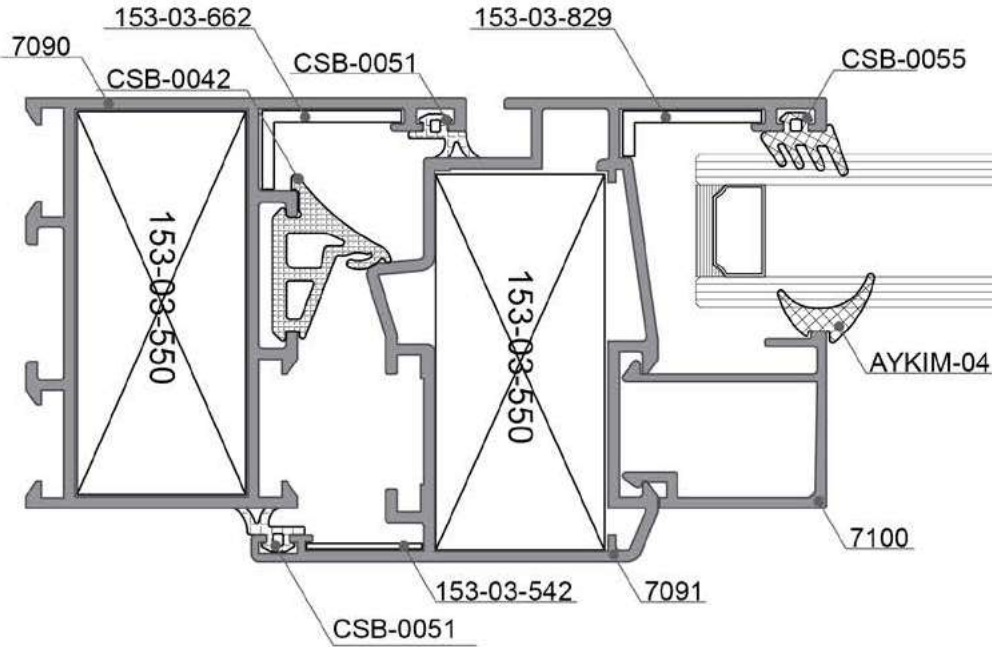
1-A DETAYI
DETAIL

Ölçek: 1:1 Scale: 1:1

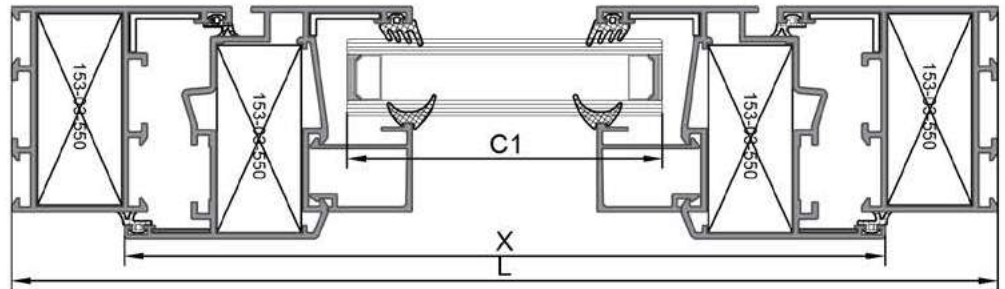
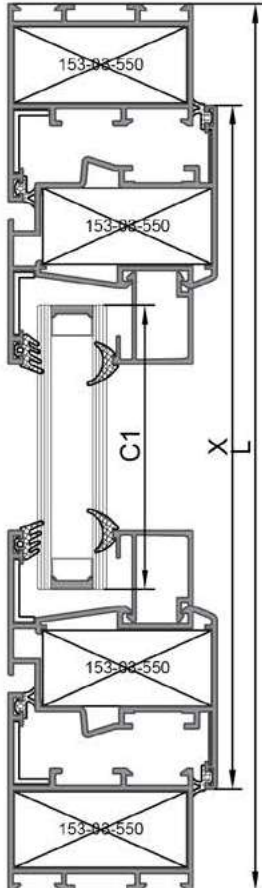

					mm.
Kasa Genişlik Frame Width	7090			2 Ad. 2 Pcs.	L
Kasa Yükseklik Frame Height	7090			2 Ad. 2 Pcs.	H
Kanat Genişlik Sash Width	7091			2 Ad. 2 Pcs.	X= L-58,8
Kanat Yükseklik Sash Height	7091			2 Ad. 2 Pcs.	Y= H-58,8
Cam Çita Profili Genişlik Bead Glazing Profile Width	7100			2 Ad. 2 Pcs.	L-165,1
Cam Çita Profili Yükseklik Bead Glazing Profile Height	7100			2 Ad. 2 Pcs.	H-208,72
Kanat Cam Genişlik Glazing Sash Width				1 Ad. 1 Pcs.	C1=L-175
Kanat Cam Yükseklik Glazing Sash Height				1 Ad. 1 Pcs.	C2=H-175

Kesim ölçüsü - cam ölçüsü vb. sorumluluğu tarafımıza ait değildir. Çizimler Ölçeksizdir.

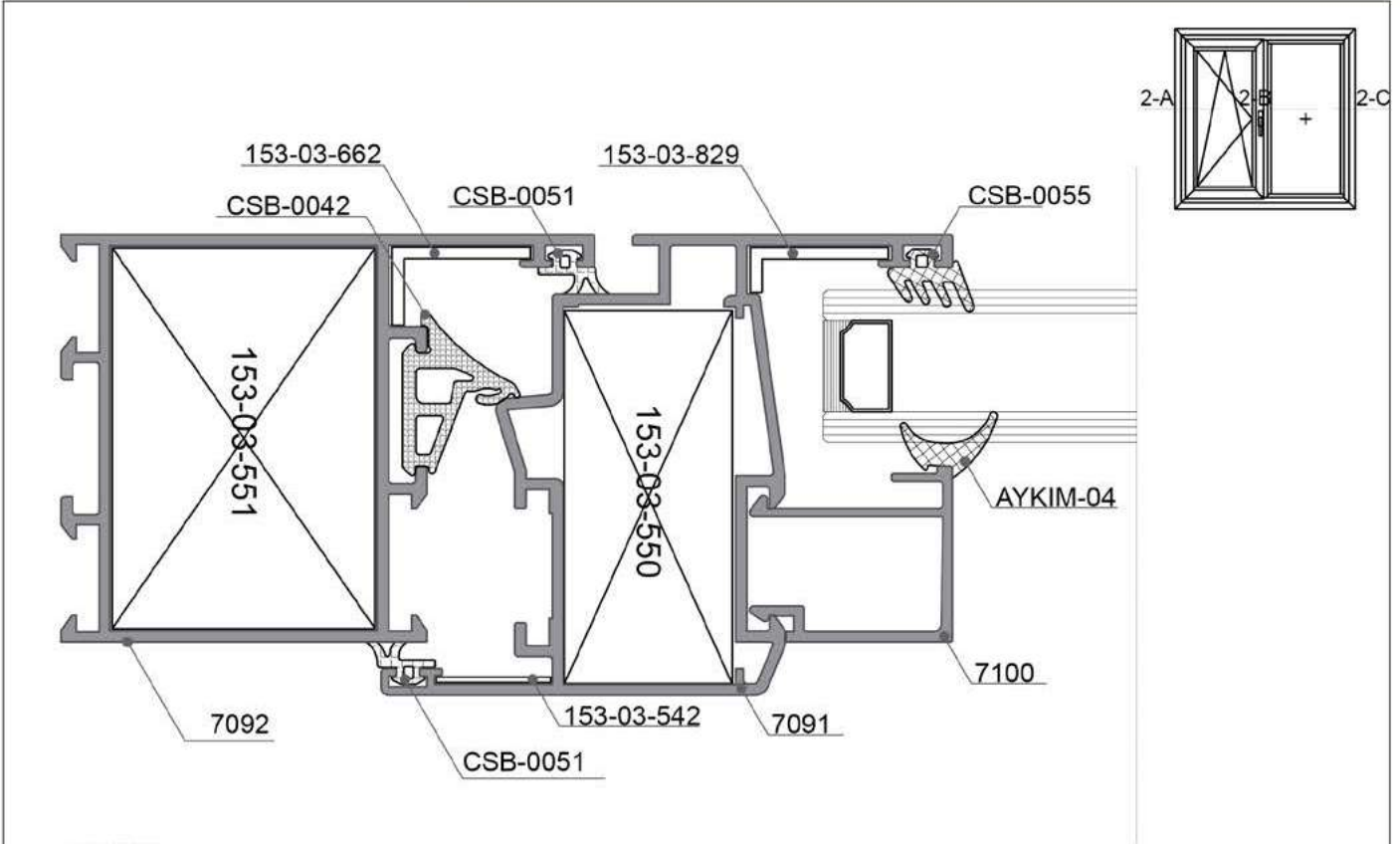

 2-A DETAYI
 DETAIL

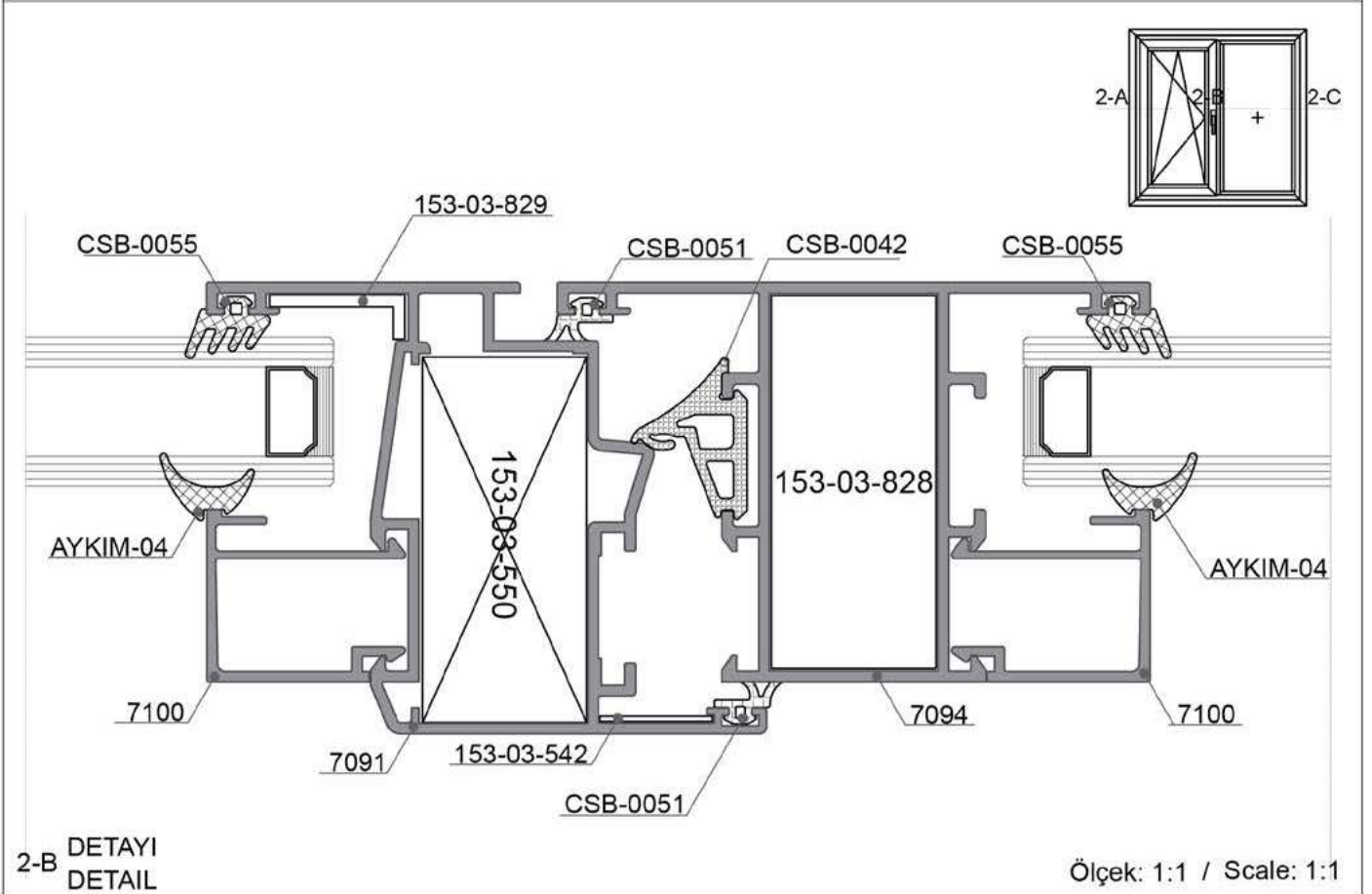
Ölçek: 1:1 / Scale: 1:1

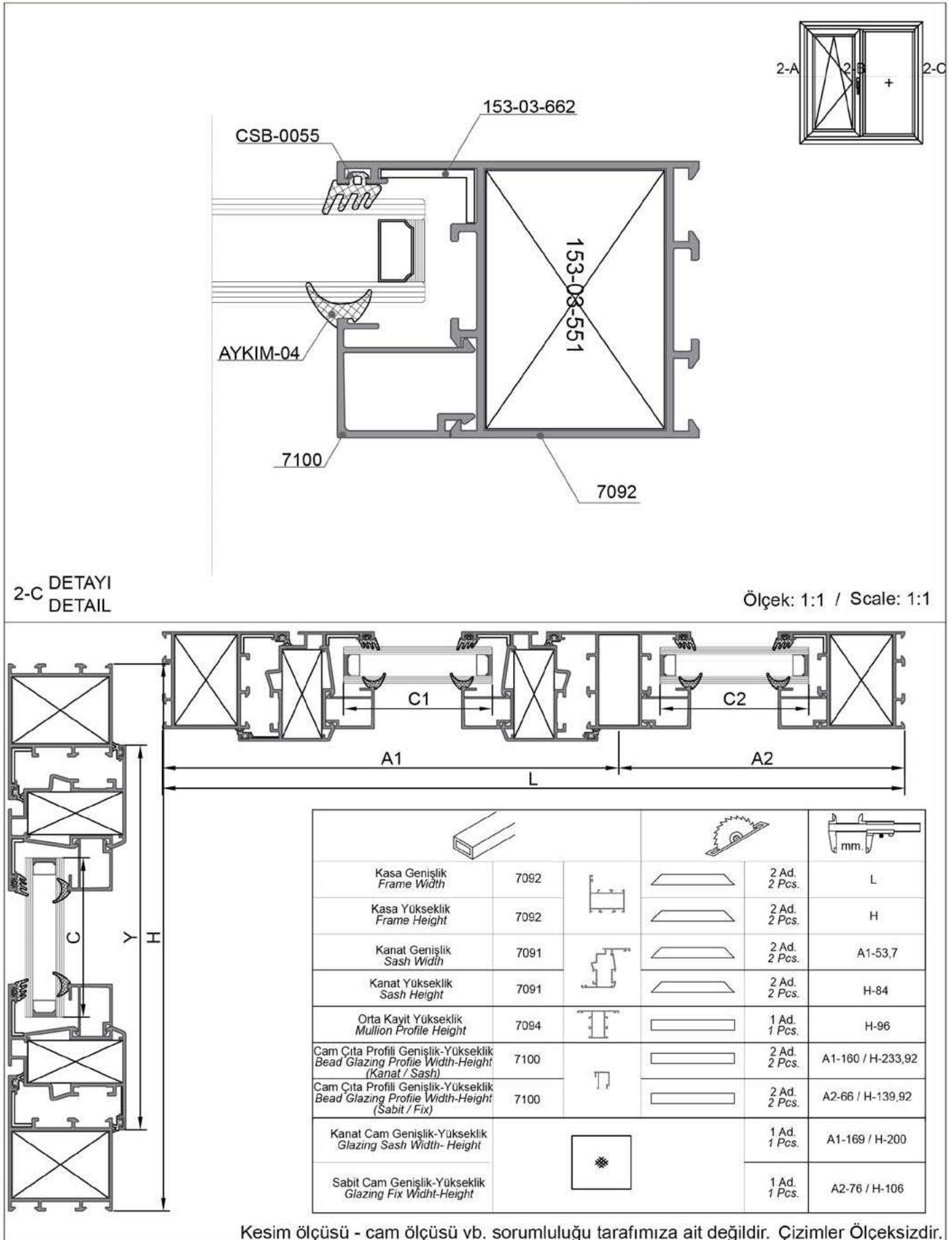

 2-B DETAYI
 DETAIL

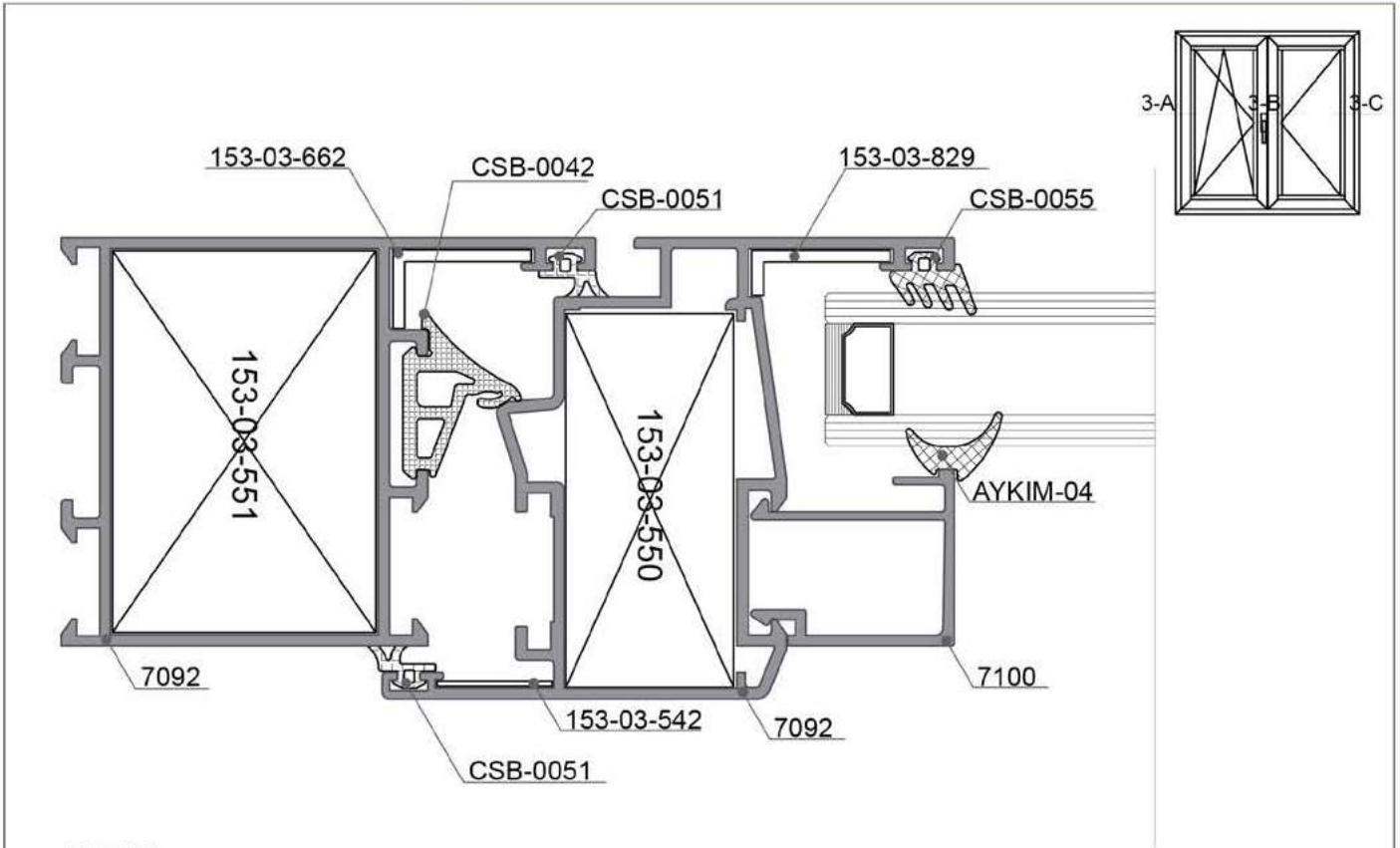
Ölçek: 1:1 / Scale: 1:1



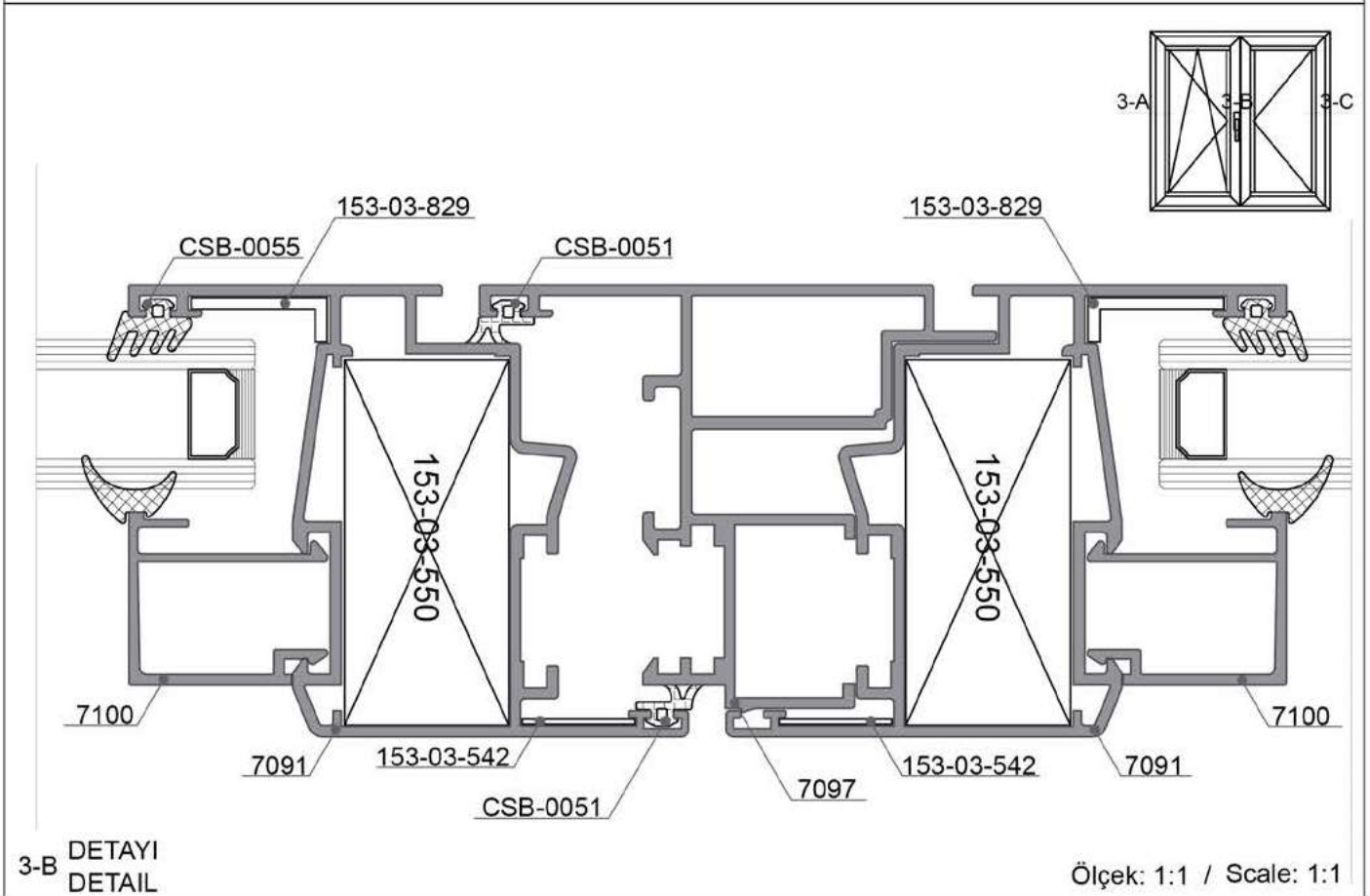

 3-A
 DETAYI
 DETAIL

Ölçek: 1:1 / Scale: 1:1

 3-B
 DETAYI
 DETAIL

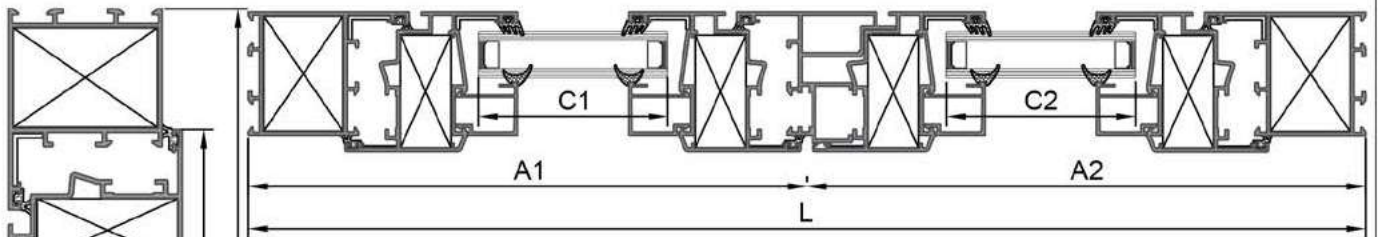
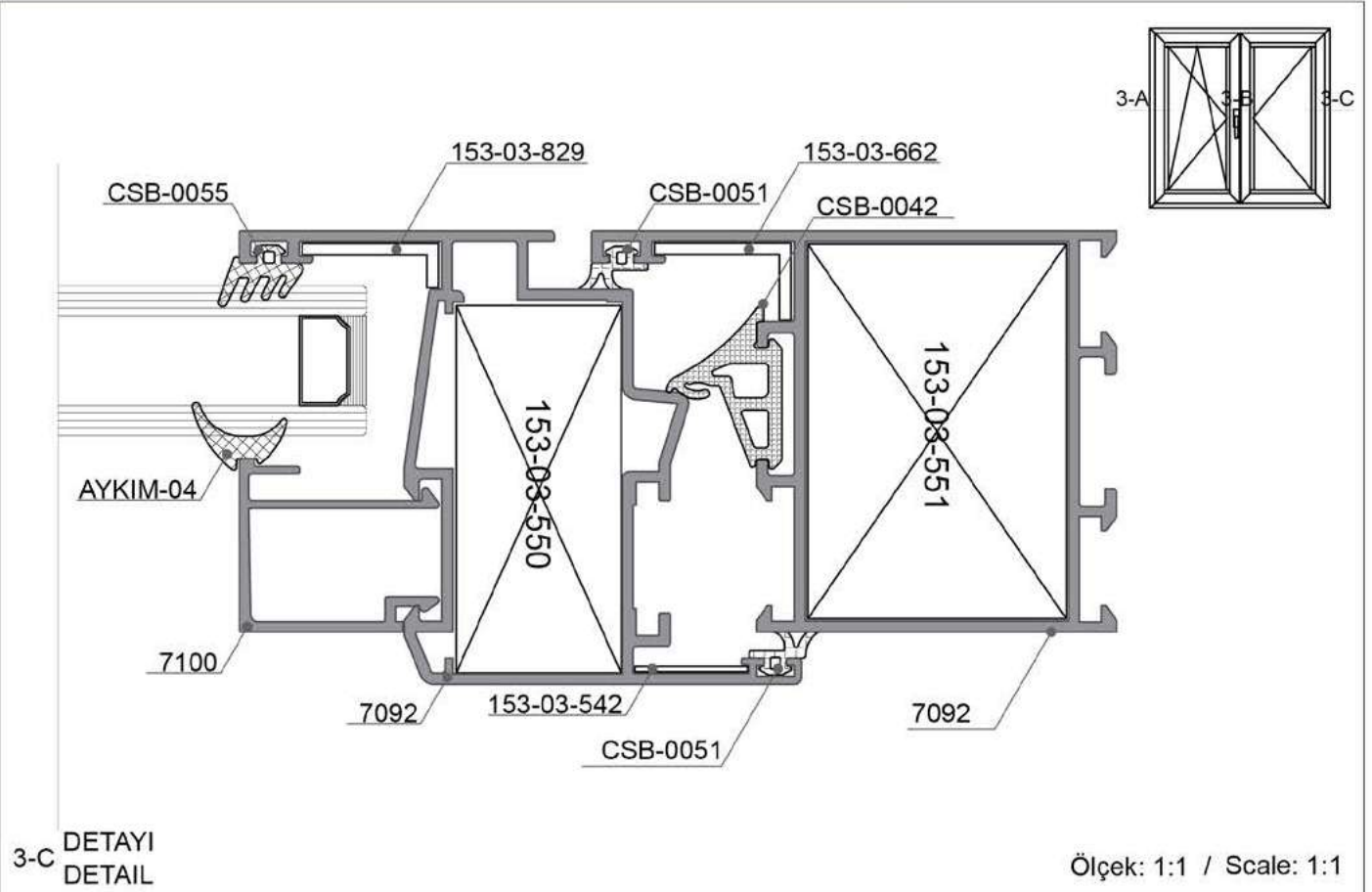
Ölçek: 1:1 / Scale: 1:1



Kasa Genişlik Frame Width	7092			2 Ad. 2 Pcs.	L
Kasa Yükseklik Frame Height	7092			2 Ad. 2 Pcs.	H
1.Kanat Genişlik-Yükseklik 1.Sash Width-Height	7091			2 Ad. / 2 Pcs. 2 Ad. / 2 Pcs.	A1-44,5 H-84
2.Kanat Genişlik-Yükseklik 2.Sash Width-Height	7091			2 Ad. / 2 Pcs. 2 Ad. / 2 Pcs.	A2-44,5 H-84
Orta Kayıt Yükseklik Mullion Profile Height	7097			1 Ad. 1 Pcs.	H-129,8
Cam Cıta Profili Genişlik-Yükseklik Bead Glazing Profile Width-Height (1.Kanat / 1.Sash)	7100			2 Ad. 2 Pcs.	A1-150,8 H-233,92
Cam Cıta Profili Genişlik-Yükseklik Bead Glazing Profile Width-Height (2.Kanat / 2.Sash)	7100			2 Ad. 2 Pcs.	A2-150,8 H-233,92
1. Kanat Cam Genişlik-Yükseklik Glazing Sash Width- Height				1 Ad. 1 Pcs.	A1-161 / H-200
2. Kanat Cam Genişlik-Yükseklik Glazing Sash Width- Height				1 Ad. 1 Pcs.	A2-161 / H-200

Kesim ölçüsü - cam ölçüsü vb. sorumluluğu tarafımıza ait değildir.

Çizimler Ölçeksizdir.

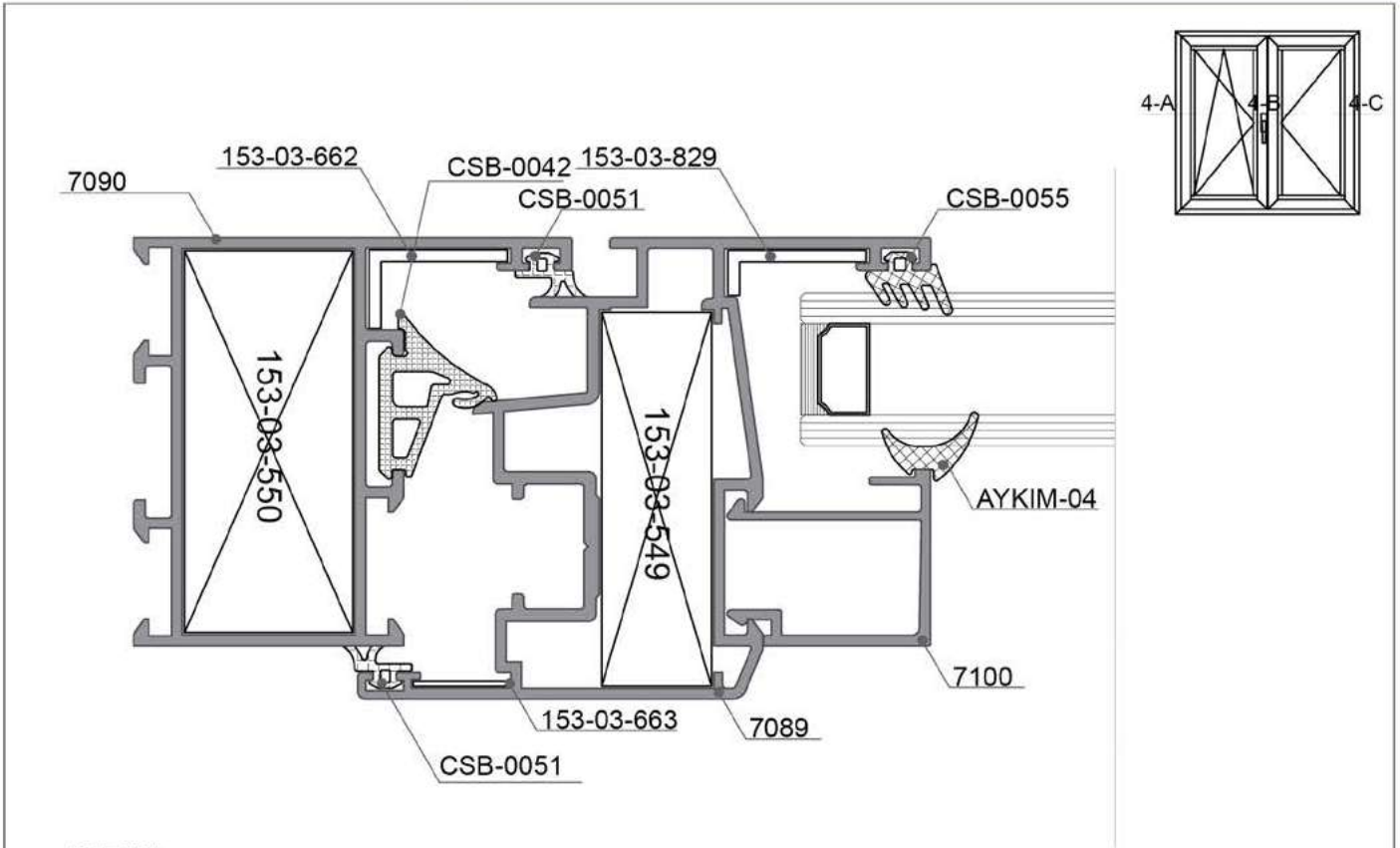
 4-A DETAYI
 DETAIL

Ölçek: 1:1 / Scale: 1:1

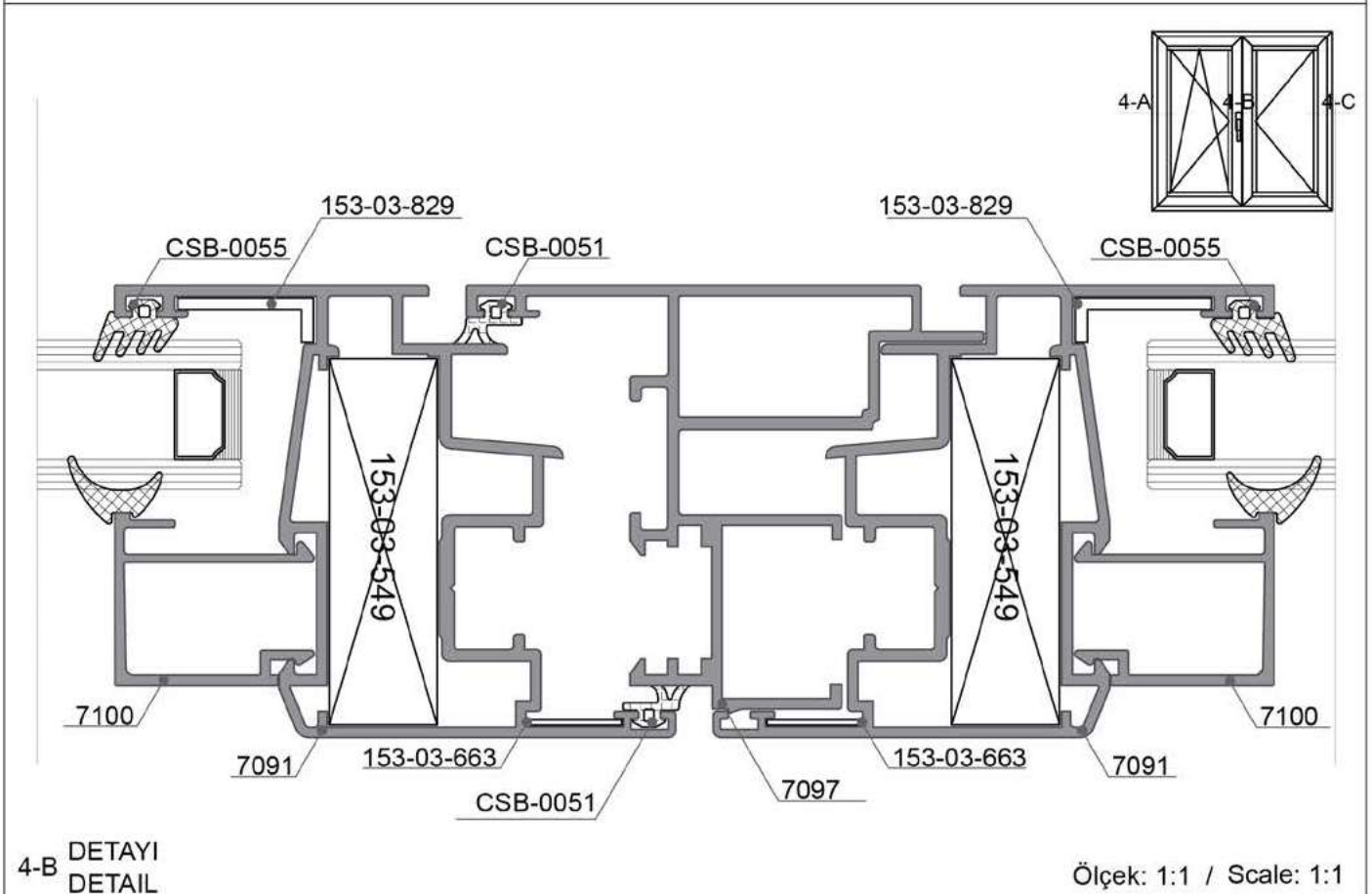

 4-B DETAYI
 DETAIL

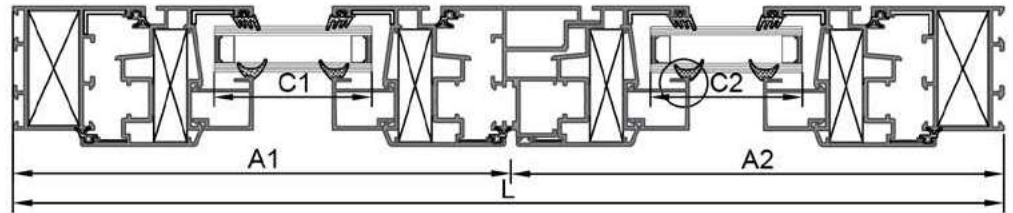
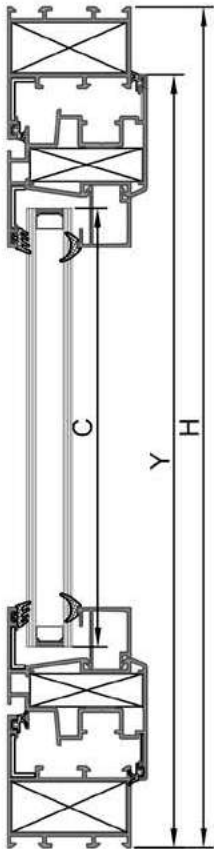
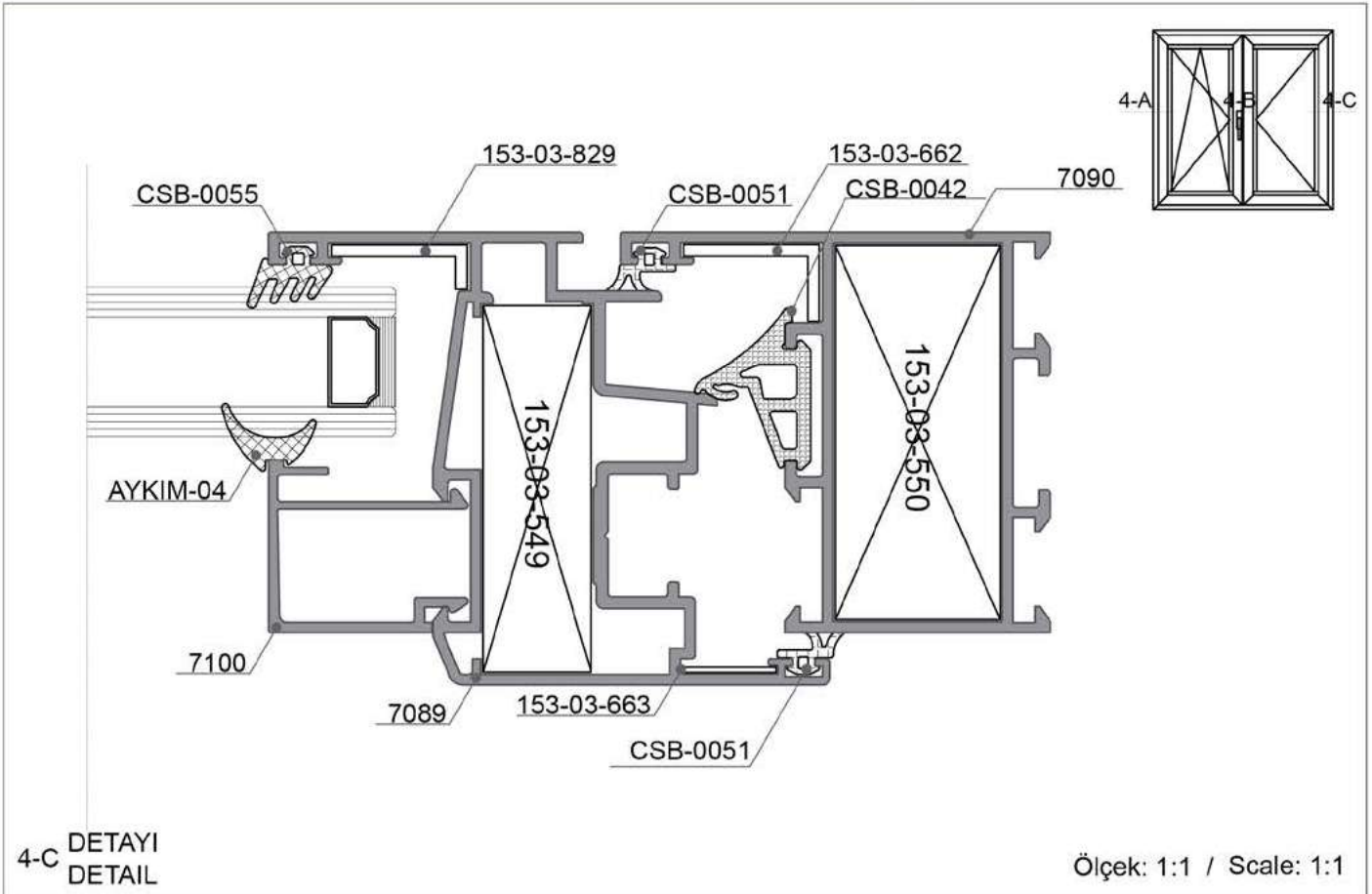
Ölçek: 1:1 / Scale: 1:1

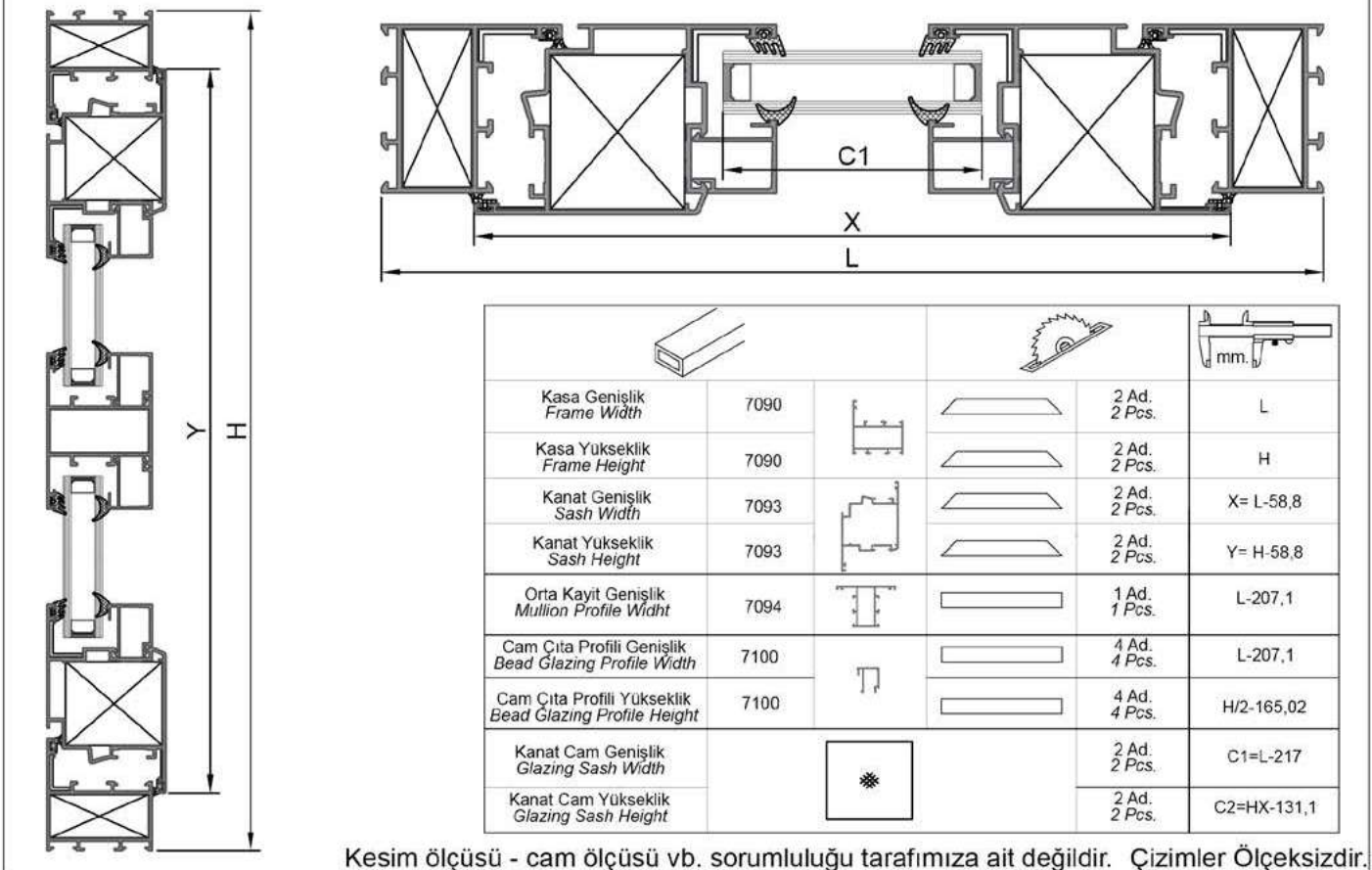
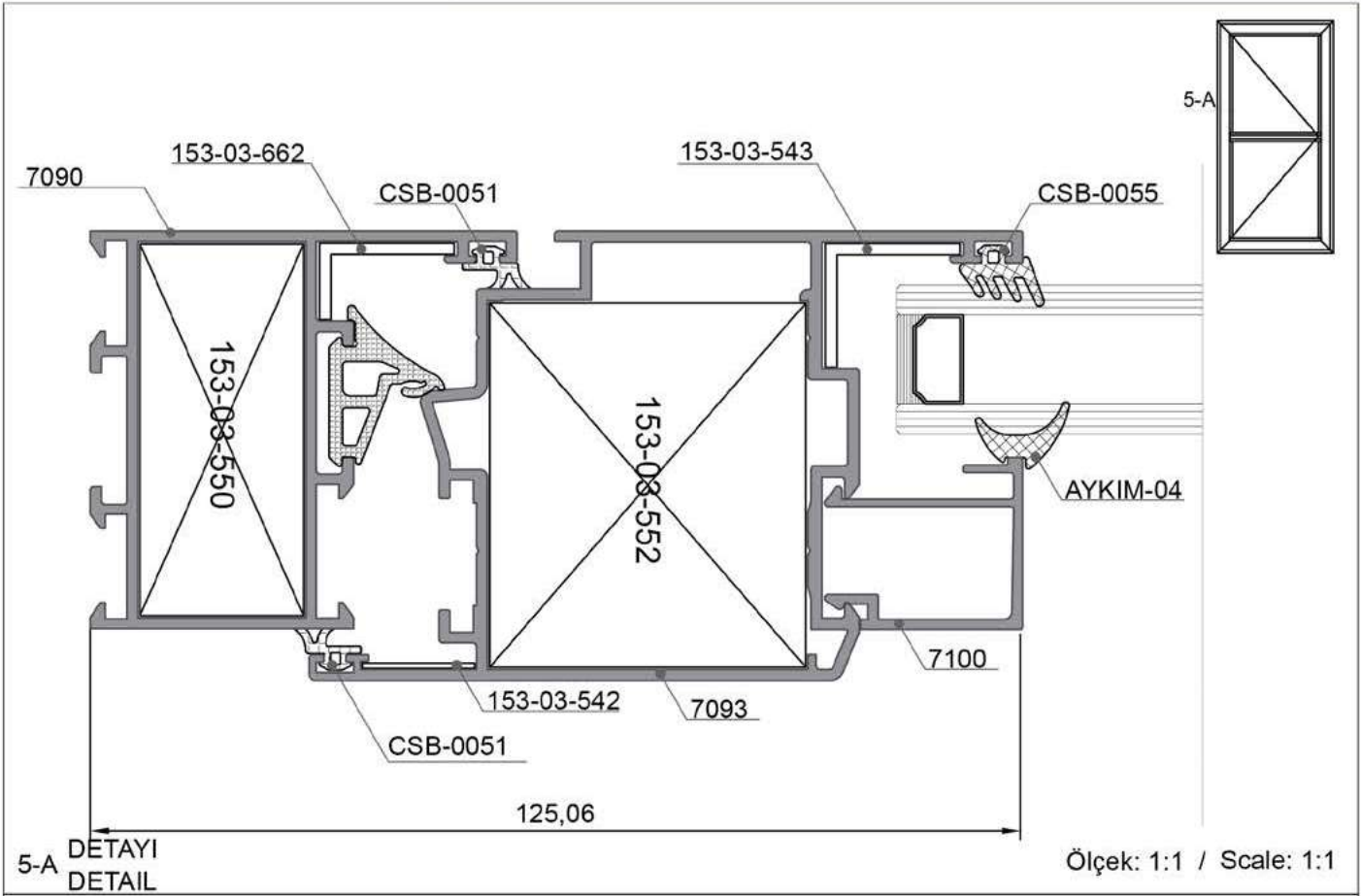

Kasa Genişlik Frame Width	7090			2 Ad. 2 Pcs.	L
Kasa Yükseklik Frame Height	7090			2 Ad. 2 Pcs.	H
1.Kanat Genişlik-Yükseklik 1.Sash Width-Height	7089			2 Ad. / 2 Pcs. 2 Ad. / 2 Pcs.	A1-31,95 H-58,8
2.Kanat Genişlik-Yükseklik 2.Sash Width-Height	7089			2 Ad. / 2 Pcs. 2 Ad. / 2 Pcs.	A2-31,95 H-58,8
Orta Kayıt Yükseklik Mullion Profile Height	7097			1 Ad. 1 Pcs.	H-58,8
Cam Çita Profili Genişlik-Yükseklik Bead Glazing Profile Width-Height (1.Kanat / 1.Sash)	7100			2 Ad. 2 Pcs.	A1-138,2 H-208,72
Cam Çita Profili Genişlik-Yükseklik Bead Glazing Profile Width-Height (2.Kanat / 2.Sash)	7100			2 Ad. 2 Pcs.	A2-138,2 H-208,72
1. Kanat Cam Genişlik-Yükseklik Glazing Sash Width- Height				1 Ad. 1 Pcs.	A1-148 / H-175
2. Kanat Cam Genişlik-Yükseklik Glazing Sash Width- Height				1 Ad. 1 Pcs.	A2-148 / H-175

Kesim ölçüsü - cam ölçüsü vb. sorumluluğu tarafımıza ait değildir. Çizimler Ölçeksizdir.



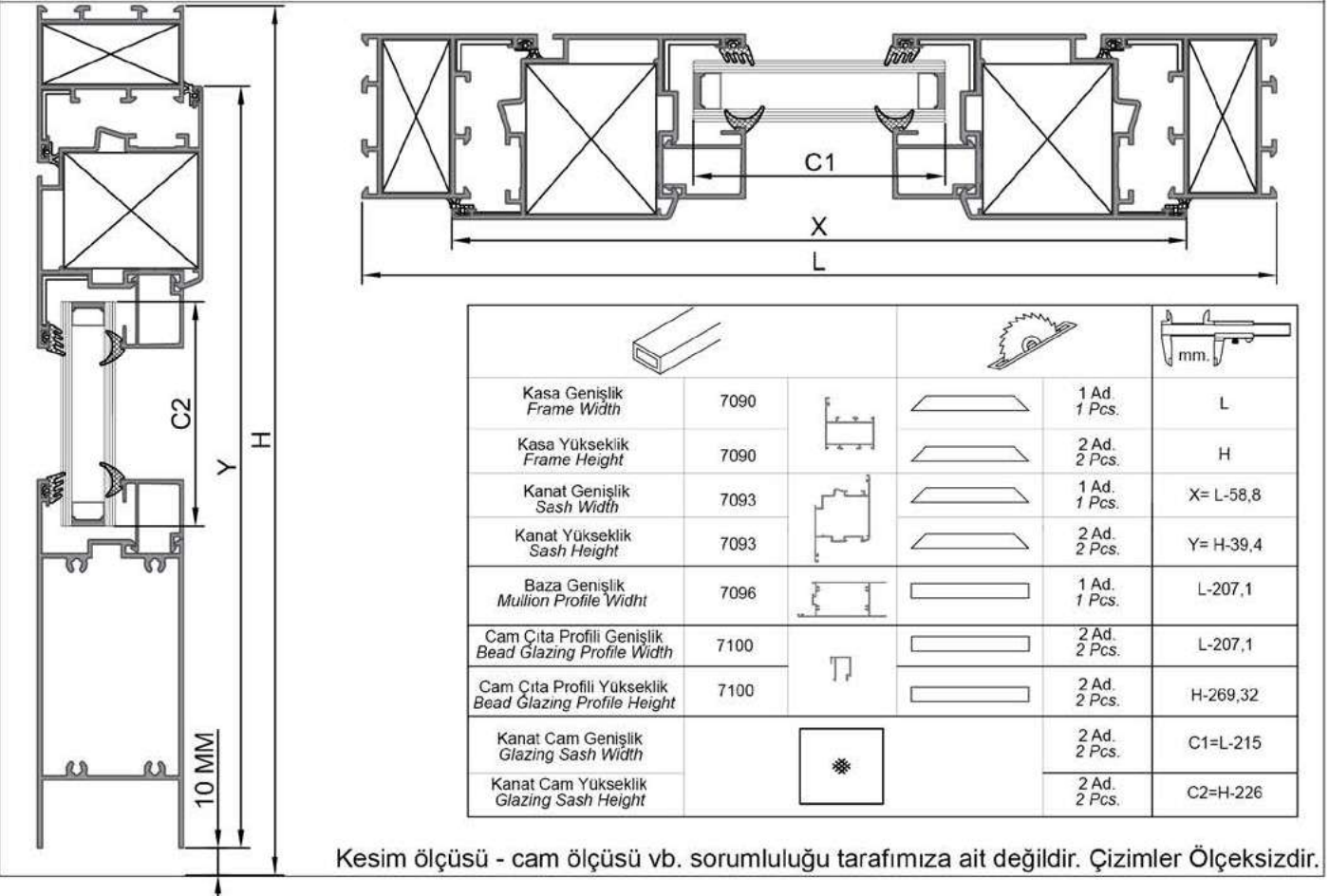
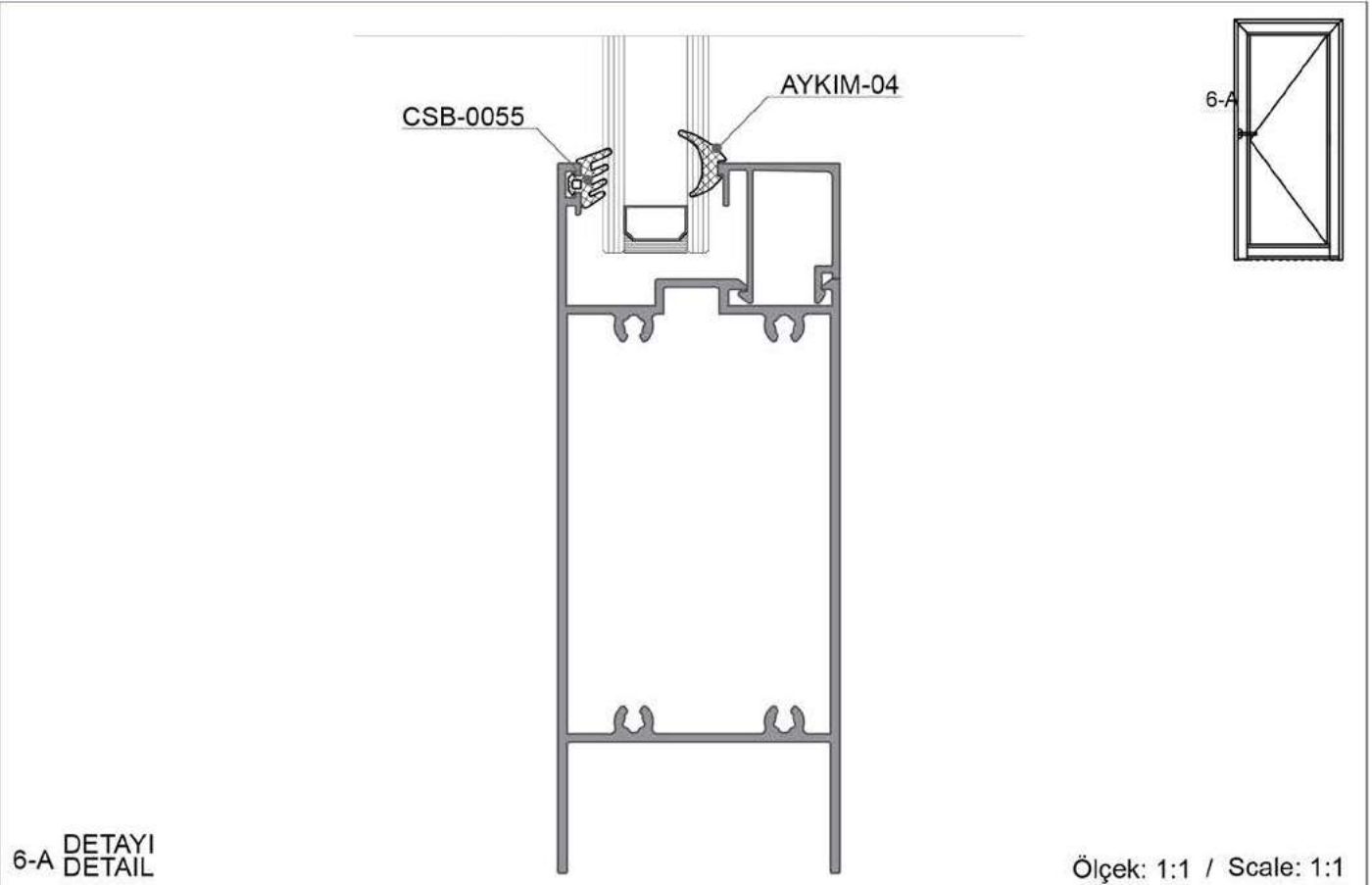

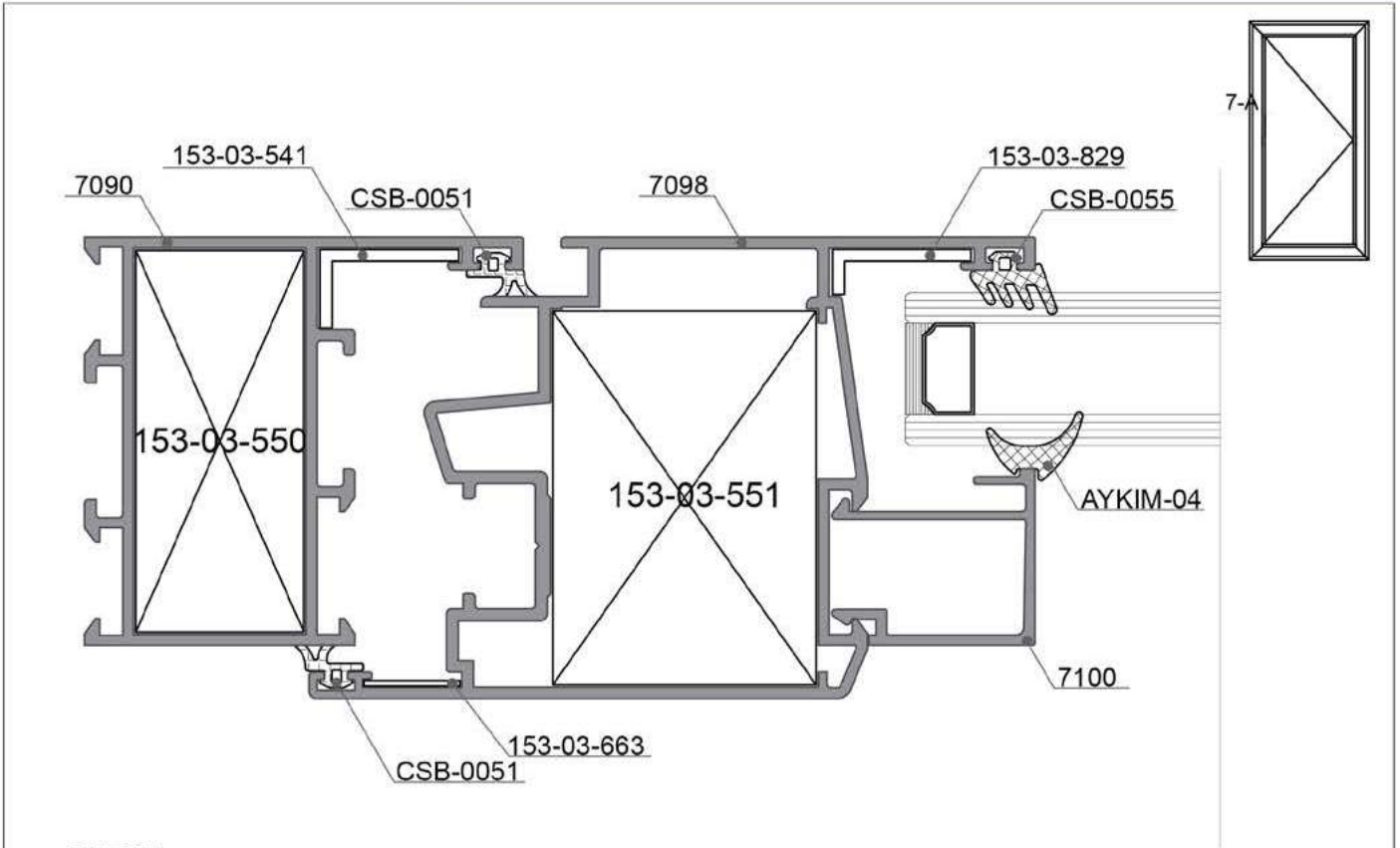



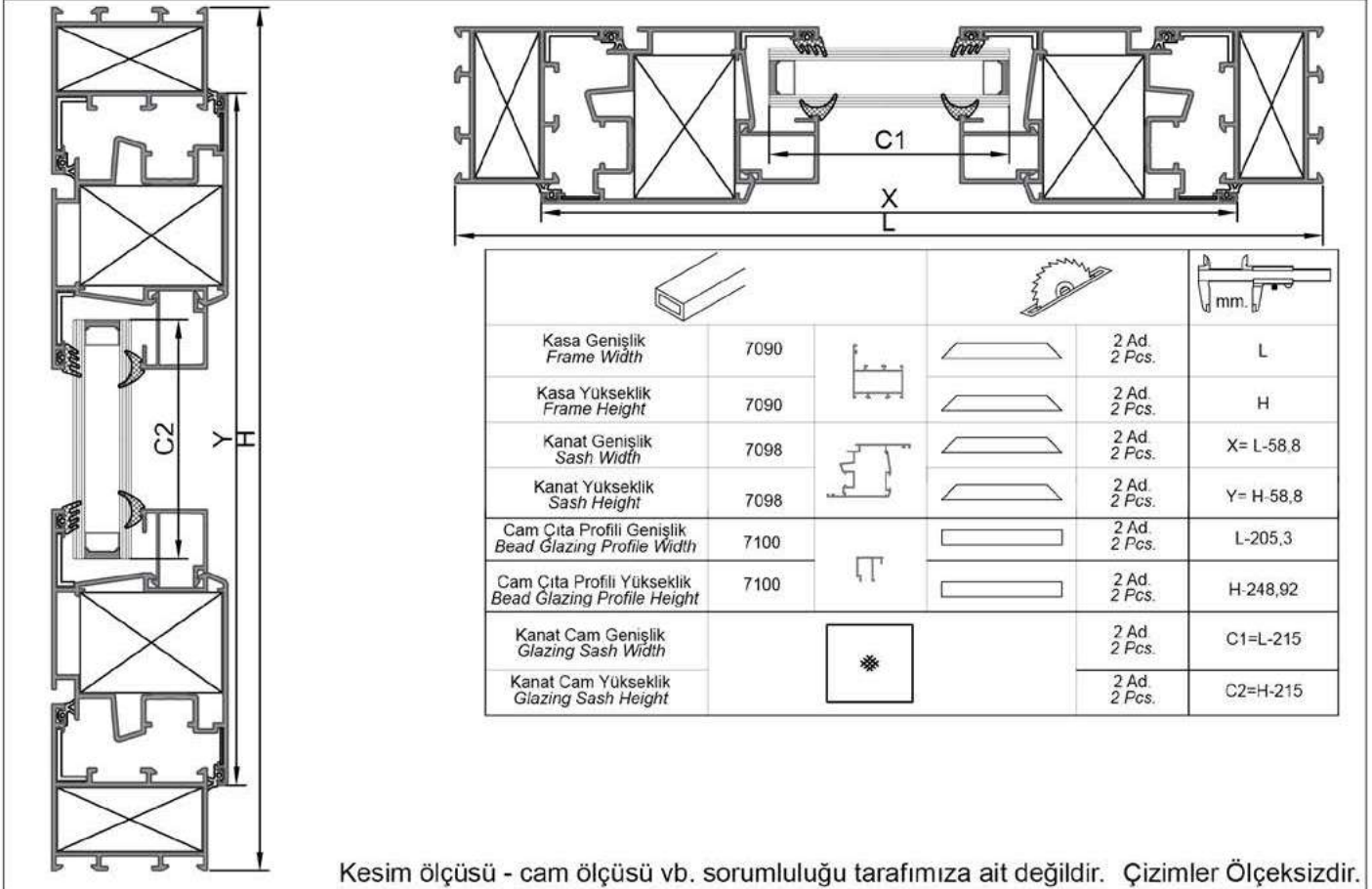





 7-A DETAYI
 DETAIL

Ölçek: 1:1 / Scale: 1:1

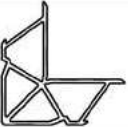
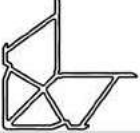

Kesim ölçüsü - cam ölçüsü vb. sorumluluğu tarafımıza ait değildir. Çizimler Ölçeksizdir.

Ürün Çizimi Drawing	Ürün Kodu Product No	Ürün Adı Product Name	Kullanıldığı Profiller Profiles Used
	CSB-0051	Kanat Bini Fitili Accoustical Gasket for Sash	
	CSB-0055	Dış Cam Fitili Outer Window Wick	
	AYKIM-03	Cam Kama Fitili Glazing Wedge Gasket (Cam Tercihine Göre) (Optional Glass Size)	
	153-03-541	ZZZZ AAAA	-
	153-03-542	ZZZZ AAAA	-
	153-03-663	ZZZZ AAAA	-
	153-03-549	7102 (14,4 mm) / 49mm Joint Corner	7089
	153-03-550	7103 (22 mm) / 49mm Joint Corner	7090 7091 7094
	153-03-551	7104 (34,5 mm) / 49mm Joint Corner	7092 7095 7098
	153-03-552	7105 (42,5 mm) / 49mm Joint Corner	7093

1.
ADIM

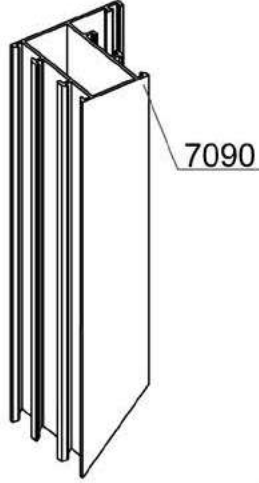

153-03-550

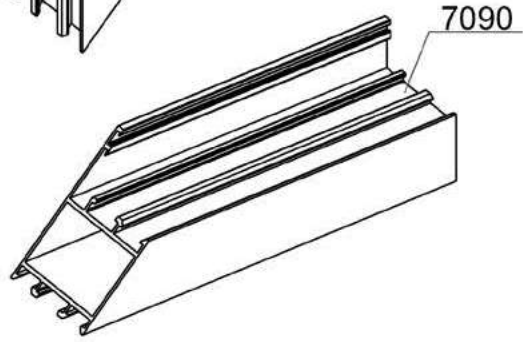
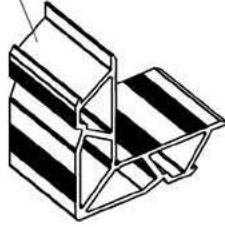

2.
ADIM

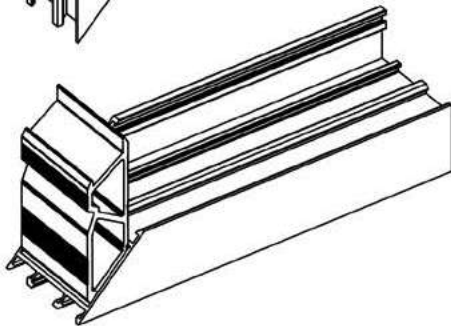



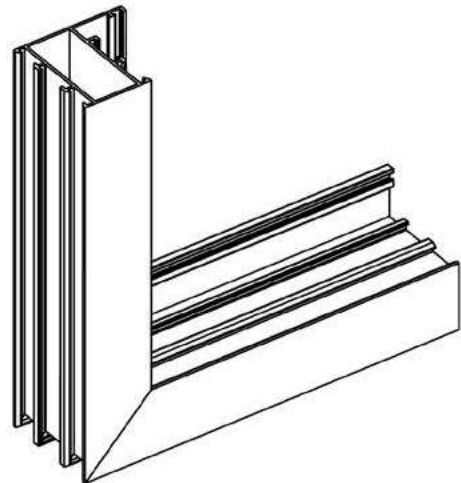

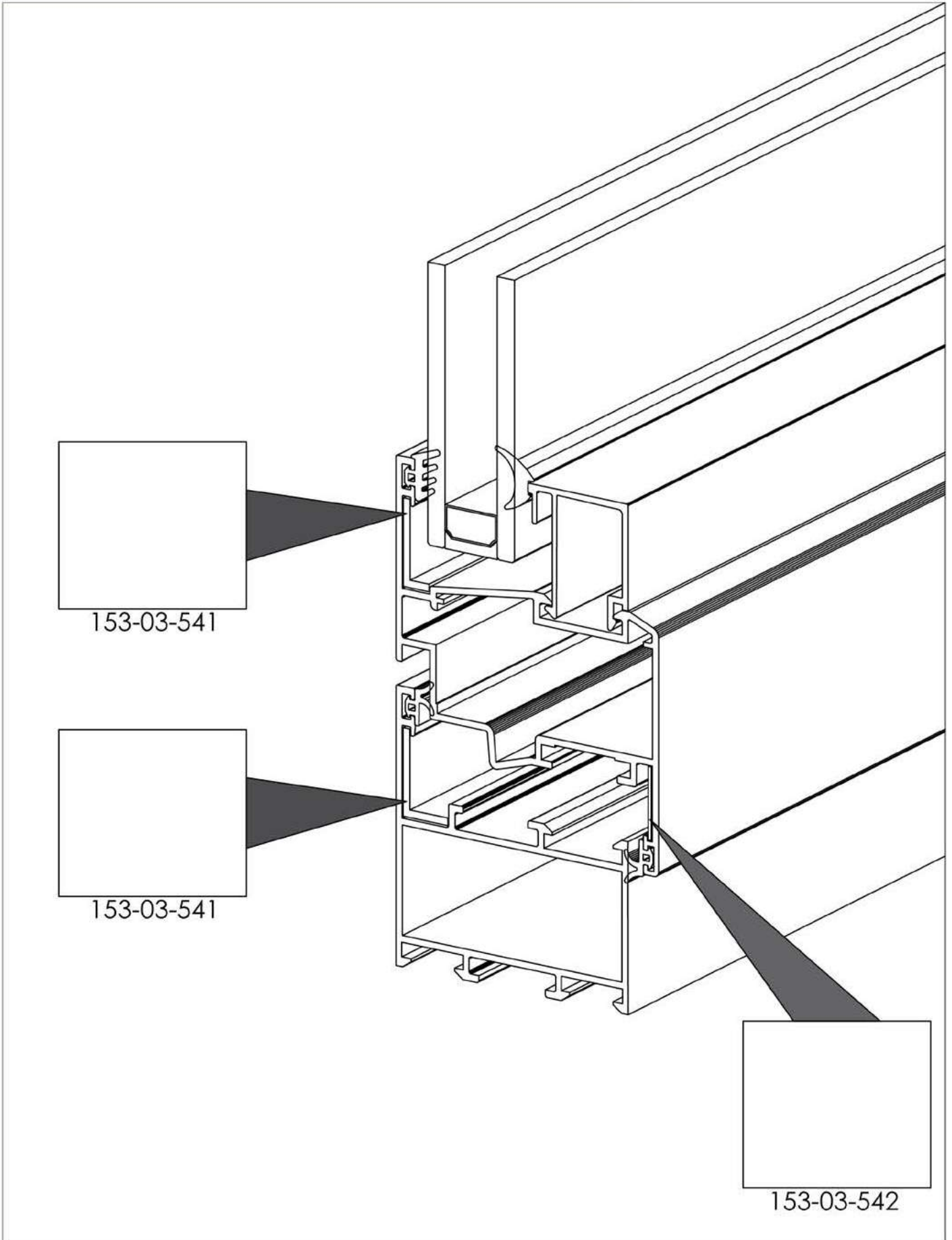
3.
ADIM





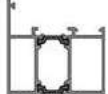
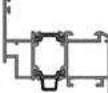

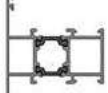
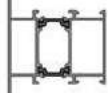

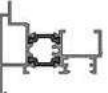
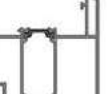
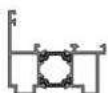

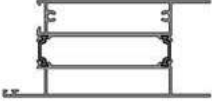
SD22
SD23
SD32
SD33
SD35
WD42
WD52
FS72

SD52

Profil Profile	Profil Kodu Profile Nr	Ağırlık (kg/m.) Weight (kg/m.)	X mm.	Y mm.	Jx cm ⁴	Jy cm ⁴
	7065-7066 Pencere Kasa Pr. Window Frame Pr.	1,337 kg/mt	63 mm	57,4 mm	21,98	9,03
	7067-7068 Kapı Kasa Pr. Door Frame Pr.	1,544 kg/mt	63 mm	70 mm	26,28	15,58
	7063-7064 Pencere Kanat Pr. Window Sash Pr.	1,437kg/mt	70 mm	75 mm	33,16	9,87
	7071-7072 İspanyolet Pencere Kanat Pr. Espagnolette Window Sash Pr.	1,485kg/mt	70 mm	75 mm	33,73	9,58
	7073-7074 Kapı Kanat Pr. Door Sash Pr.	1,845kg/mt	70 mm	96 mm	48,62	26,50
	7069-7066 Orta Kayıt Pr. Middle Transom Pr.	1,435kg/mt	62,98 mm	79,4 mm	23,20	13,06
	7070-7068 Orta Kayıt Pr. Middle Transom Pr.	1,641kg/mt	63 mm	92 mm	27,18	23,32
	7082-7083 İspanyolet Kapı Kanat Pr. Espagnolette Door Sash Pr.	1,934kg/mt	70 mm	95 mm	50,04	26,43
	7075-7076 Hareketli Orta Kayıt Pr.	1,318kg/mt	69,2 mm	66,75 mm	20,48	8,22
	7079-7078 Dışa Açılım Kapı Kanat Profili Outside Door Sash Profile	1,930kg/mt	70 mm	96 mm	38,07	34,77
	7080-7081	1,225kg/mt	63 mm	55,2 mm	18,11	6,51

Profil Profile	Profil Kodu Profile Nr	Ağırlık (kg/m.) Weight (kg/m.)	X mm.	Y mm.	Jx cm ⁴	Jy cm ⁴
	7085-7084 Baza Pr. Kick Plate Pr.	2,884kg/mt	135 mm	63,3 mm	117,65	51,52
	7077 Cam Çita Pr. Glazing Bead Pr.	0,280kg/mt	18,1 mm	26,61 mm		
	7086 Cam Çita Pr. Glazing Bead Pr.	0,294kg/mt	24,6 mm	26,61 mm		
	7087 Cam Çita Pr. Glazing Bead Pr.	0,304kg/mt	27,6 mm	26,61 mm		
	7088 Cam Çita Pr. Glazing Bead Pr.	0,320kg/mt	32,6 mm	26,61 mm		
	7100 Cam Çita Pr. Glazing Bead Pr.	0,288kg/mt	23,1 mm	26,61 mm		

Pencere Kasa Profili - Window Frame Pr.

7065-7066

1,337 kg/mt

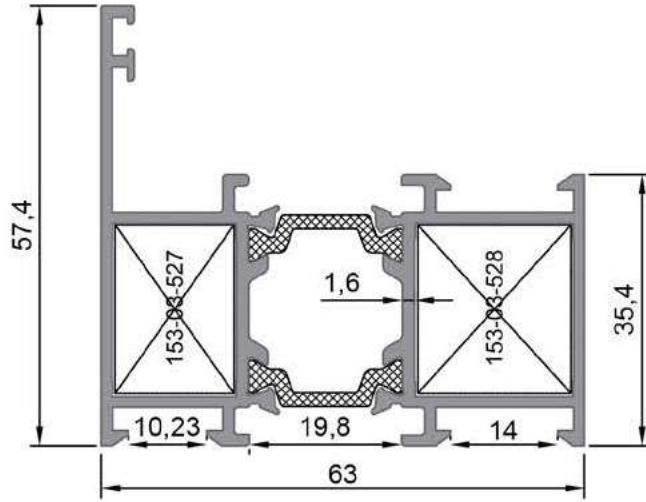

7065-7066

Kod/Code	Et Kalın./Wall Thk.	Ürün Adı / Prod. Name	Ağırlığı / Weight	Köşe Takozu / C. Cleat
7065-7066	1,6 mm	Pencere Kasa Profili - Window Frame Pr.	1,337 kg/mt	-

Kapı Kasa Profili - Door Frame Pr.

7067-7068

1,544 kg/mt

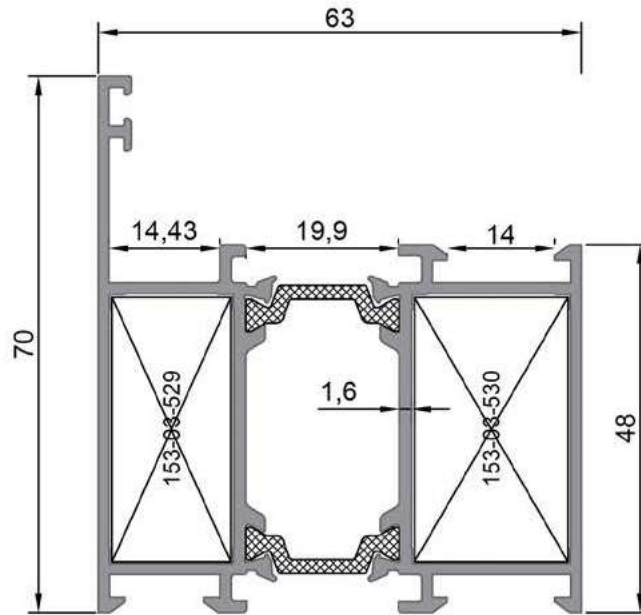

7067-7068

Kod/Code	Et Kalın./Wall Thk.	Ürün Adı / Prod. Name	Ağırlığı / Weight	Köşe Takozu / C. Cleat
7067-7068	1,6 mm	Kapı Kasa Profili - Door Frame Pr.	1,544 kg/mt	-

Pencere Kanat Profili - Window Sash Pr.

7063-7064

1,437 kg/mt

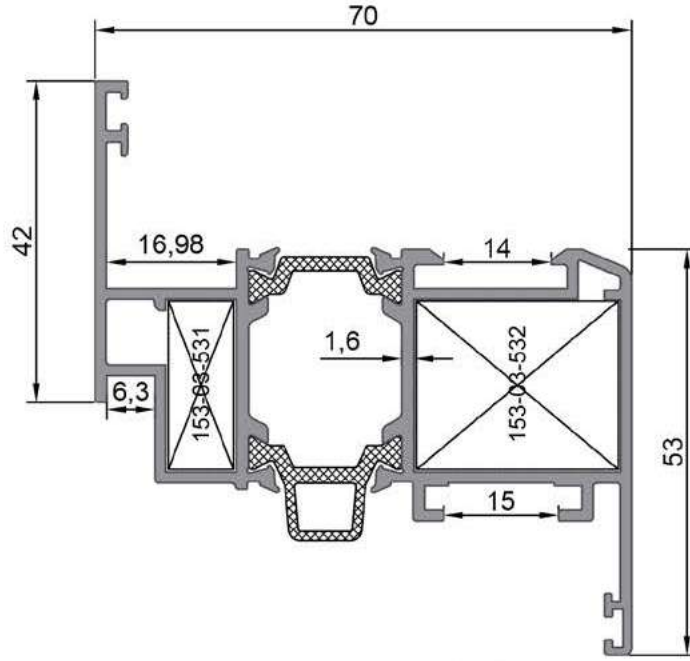

7063-7064

Kod/Code	Et Kalın./Wall Thk.	Ürün Adı / Prod. Name	Ağırlığı / Weight	Köşe Takozu / C. Cleat
7063-7064	1,6 mm	Pencere Kanat Pr. / Window Sash Pr.	1,437 kg/mt	-

Kapı Kanat Profili - Door Sash Pr.

7073-7074

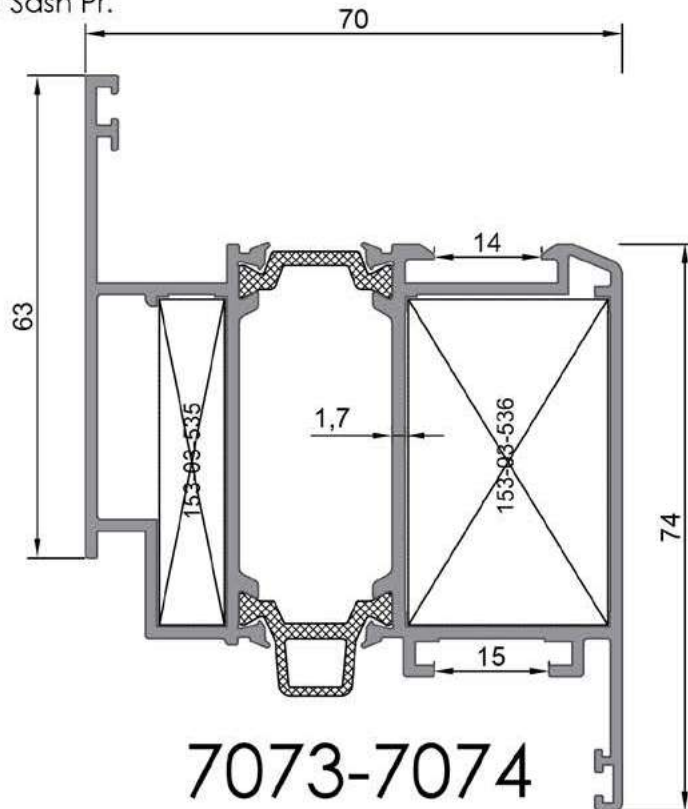
1,845 kg/mt



7073-7074

Kod/Code	Et Kalın./Wall Thk.	Ürün Adı / Prod. Name	Ağırlığı / Weight	Köşe Takozu / C. Cleat
7073-7074	1,7 mm	Kapı Kanat Profili - Door Sash Pr.	1,845 kg/mt	-

İspanyolet Pencere Kanat Profili - Espagnolette Window Sash Pr.

7071-7072

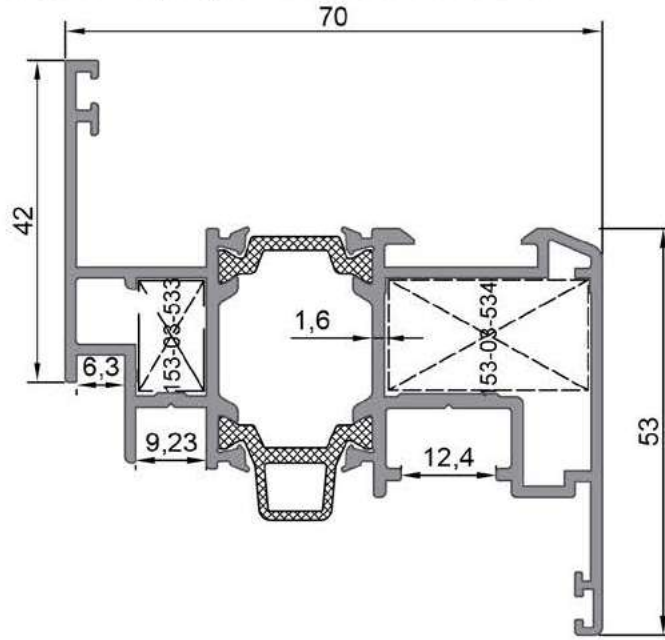
1,485 kg/mt



7071-7072

Kod/Code	Et Kalın./Wall Thk.	Ürün Adı / Prod. Name	Ağırlığı / Weight	Köşe Takozu / C. Cleat
7071-7072	1,6 mm	İspanyolet Pencere Kanat Pr. / Espagnolette Window Sash Pr.	1,485 kg/mt	-

İspanyolet Kapı Kanat Profili - Espagnolette Door Sash Profile

7082-7083

1,934 kg/mt

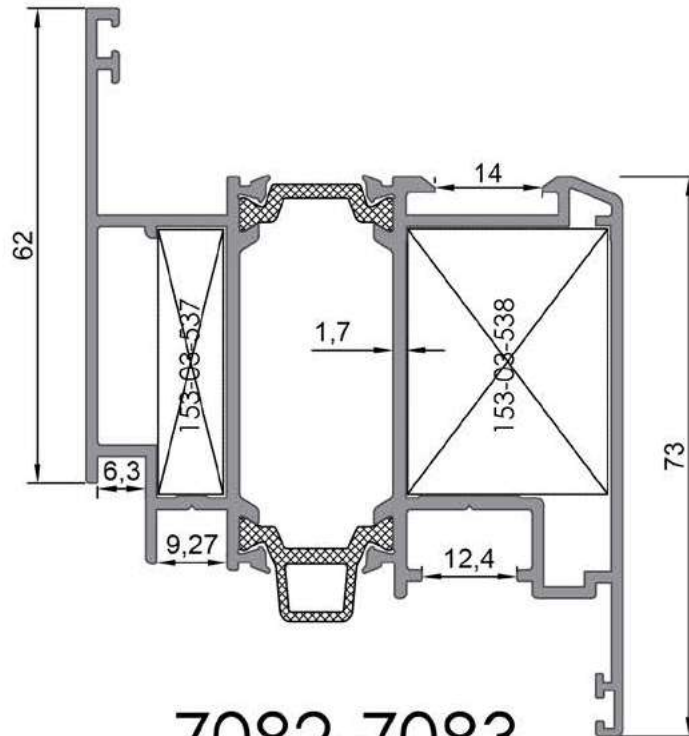

7082-7083

Kod/Code	Et Kalın./Wall Thk.	Ürün Adı / Prod. Name	Ağırlığı / Weight	Köşe Takozu / C. Cleat
7082-7083	1,7 mm	İspanyolet Kapı Kanat Pr. / Espagnolette Door Sash Pr.	1,934 kg/mt	-

Pencere Orta Kayıt Profili - Window Middle Transom Profile

7069-7066

1,435 kg/mt

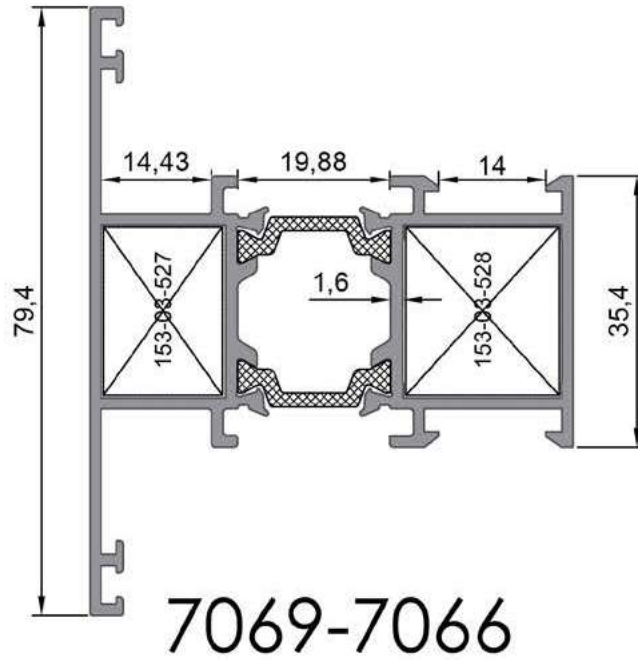

Kod/Code	Et Kalın./Wall Thk.	Ürün Adı / Prod. Name	Ağırlığı /Weight	Köşe Takozu / C. Cleat
7069-7066	1,6 mm	Pencere Orta Kayıt Pr. / Window Middle Transom Pr.	1,435 kg/mt	-

Kapı Orta Kayıt Profili - Door Middle Transom Profile

7070-7068

1,641 kg/mt

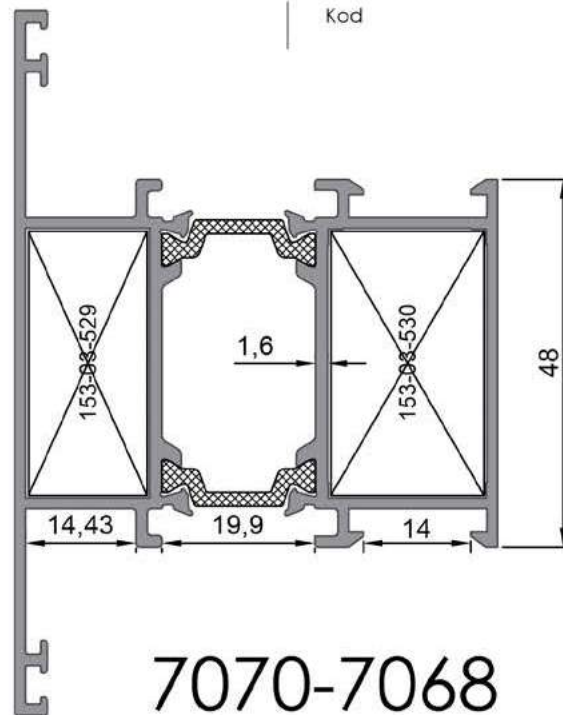

Kod/Code	Et Kalın./Wall Thk.	Ürün Adı / Prod. Name	Ağırlığı /Weight	Köşe Takozu / C. Cleat
7070-7068	1,6 mm	Kapı Orta Kayıt Profili - Door Middle Transom Profile	1,641 kg/mt	-

Dışa Açılım Kapı Kanat Profili - Outside Sash Profile

7079-7078

1,930 kg/mt

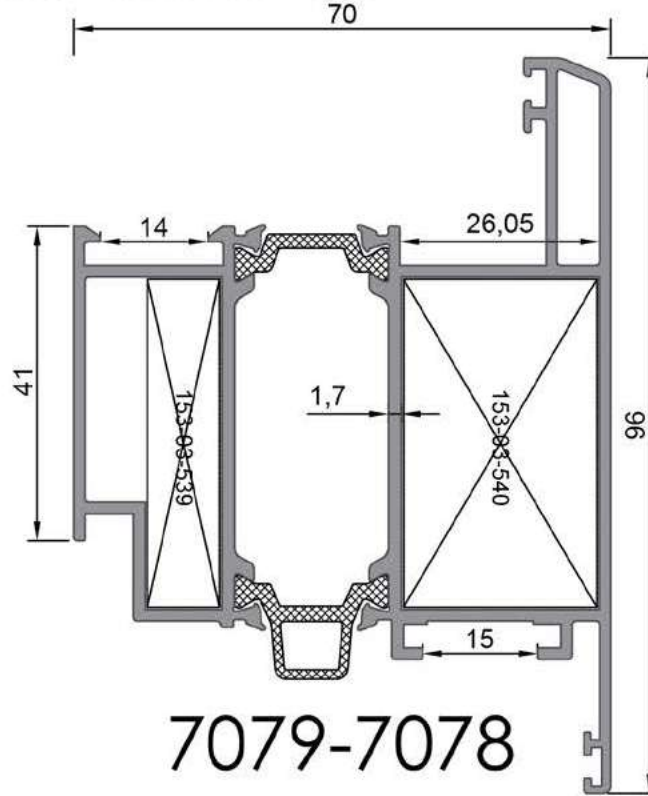

7079-7078

Kod/Code	Et Kalın./Wall Thk.	Ürün Adı / Prod. Name	Ağırlığı / Weight	Köşe Takozu / C. Cleat
7079-7078	1,6 mm	Dışa Açılım Kapı Kanat Pr. / Outside Sash Pr.	1.930 kg/mt	-

Baza Profili - Kick Plate Profile

7085-7084

2,884 kg/mt

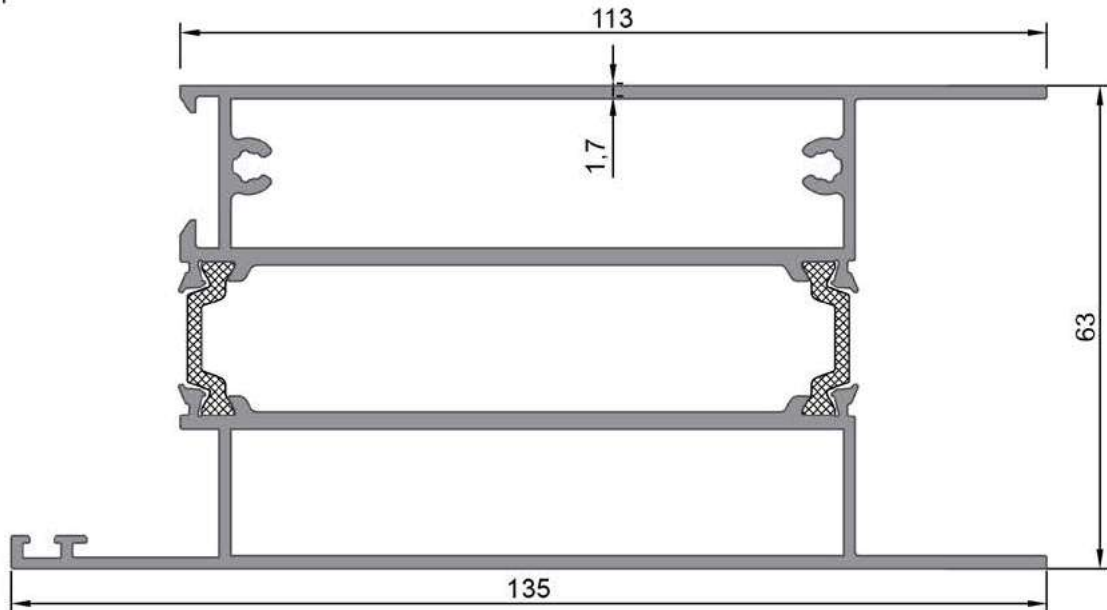

7085-7084

Kod/Code	Et Kalın./Wall Thk.	Ürün Adı / Prod. Name	Ağırlığı / Weight	Köşe Takozu / C. Cleat
7085-7084	1,6 mm	Baza Profili - Kick Plate Profile	2,884 kg/mt	-

Hareketli Orta Kayıt Pr. - Movable Middle Transom Profile

7075-7076

1,318 kg/mt

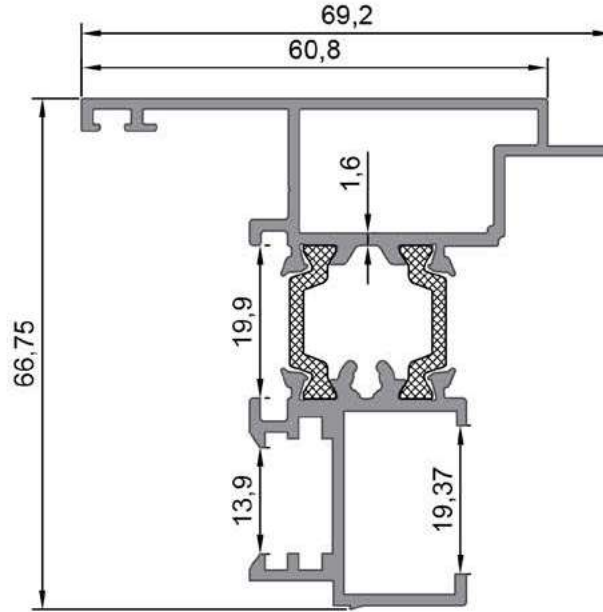

7075-7076

Kod/Code	Et Kalın./Wall Thk.	Ürün Adı / Prod. Name	Ağırlığı / Weight	Köşe Takozu / C. Cleat
7075-7076	1,6 mm	Hareketli Orta Kayıt Pr. - Movable Middle Transom Pr.	1,318 kg/mt	-

Adaptör Profili - Adapter Profile

7080-7081

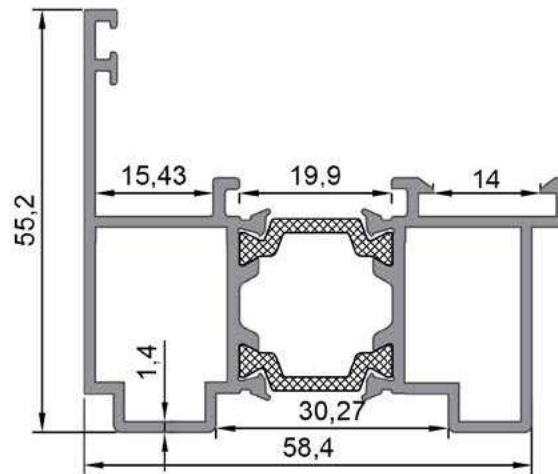
1,225 kg/mt



7080-7081

Kod/Code	Et Kalın./Wall Thk.	Ürün Adı / Prod. Name	Ağırlığı / Weight	Köşe Takozu / C. Cleat
7080-7081	1,4 mm	Adaptör Profili - Adapter Profile	1,225 kg/mt	-

Cam Çıta Pr. - Glazing Bead Pr.

7077

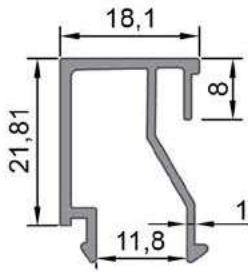
0,280 kg/mt



7077

Cam Çıta Pr. - Glazing Bead Pr.

7086

0,294 kg/mt

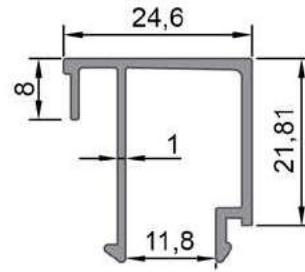

7086

Kod/Code	Et Kalın./Wall Thk.	Ürün Adı / Prod. Name	Ağırlığı / Weight	Köşe Takozu / C. Cleat
7077	1,0 mm	Cam Çıta / Glazing Bead Profile	0,280 kg/mt	-
7086	1,0 mm	Cam Çıta / Glazing Bead Profile	0,294 kg/mt	-

Cam Çıta Pr. - Glazing Bead Pr.

7087

0,304 kg/mt

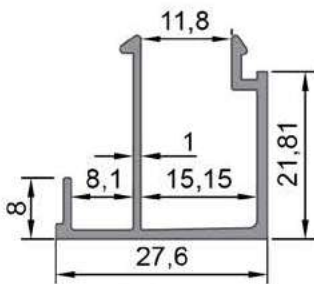

7087

Cam Çıta Pr. - Glazing Bead Pr.

7088

0,320 kg/mt

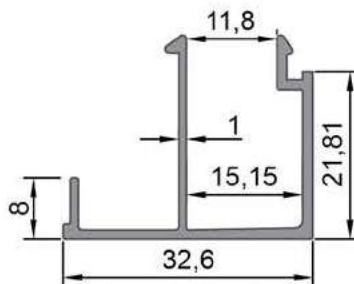

7088

Cam Çıta Pr. - Glazing Bead Pr.

7100

0,288 kg/mt

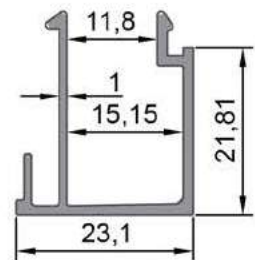

7100

Kod/Code	Et Kalın./Wall Thk.	Ürün Adı / Prod. Name	Ağırlığı / Weight	Köşe Takozu / C. Cleat
7087	1,0 mm	Cam Çıta / Glazing Bead Profile	0,304 kg/mt	-
7088	1,0 mm	Cam Çıta / Glazing Bead Profile	0,320 kg/mt	-
7100	1,0 mm	Cam Çıta / Glazing Bead Profile	0,288 kg/mt	-

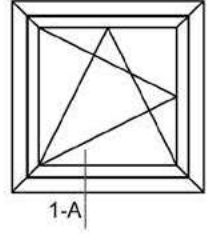
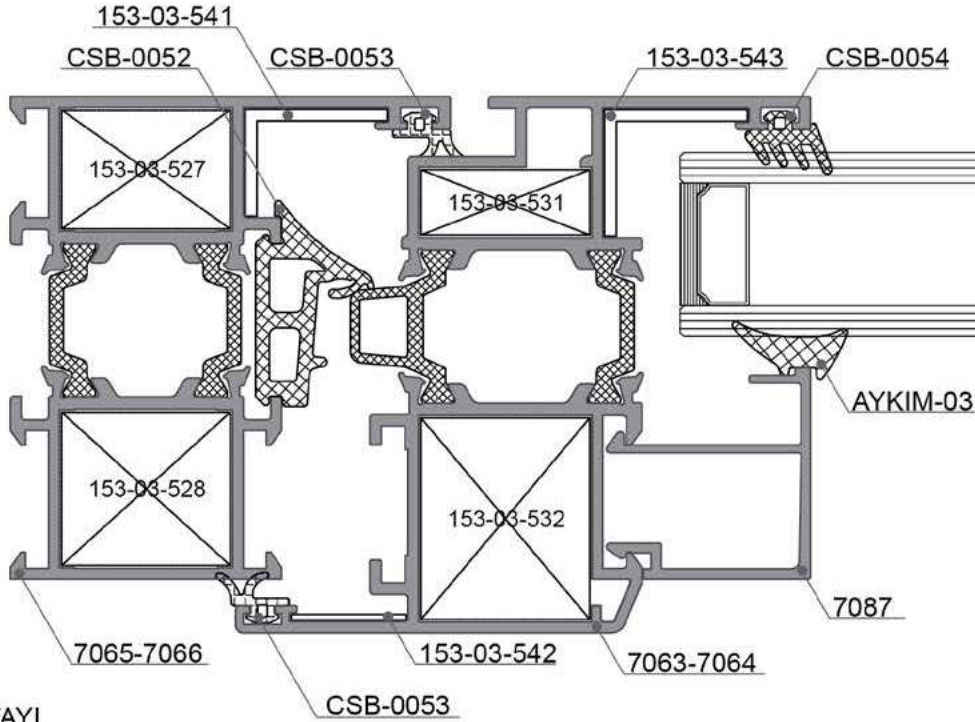
 1-A DETAYI
 DETAIL

Ölçek: 1:1 Scale: 1:1

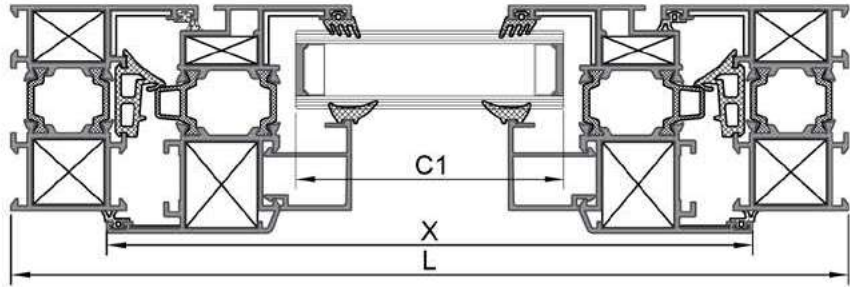
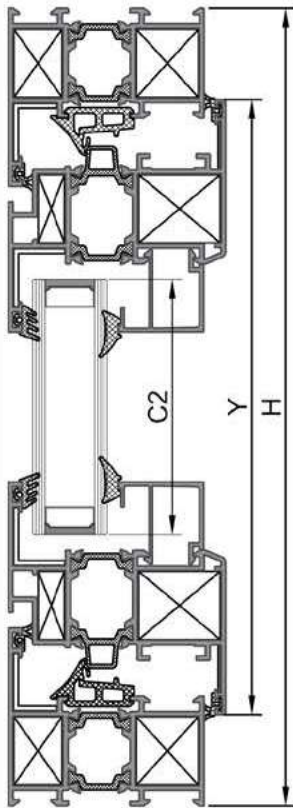

					mm.
Kasa Genişlik Frame Width	7065-7066			2 Ad. 2 Pcs.	L
Kasa Yükseklik Frame Height	7065-7066			2 Ad. 2 Pcs.	H
Kanat Genişlik Sash Width	7063-7064			2 Ad. 2 Pcs.	X= L-58,8
Kanat Yükseklik Sash Height	7063-7064			2 Ad. 2 Pcs.	Y= H-58,8
Cam Çita Profili Genişlik Bead Glazing Profile Width	7087			2 Ad. 2 Pcs.	L-165,1
Cam Çita Profili Yükseklik Bead Glazing Profile Height	7087			2 Ad. 2 Pcs.	H-208,72
Kanat Cam Genişlik Glazing Sash Width				1 Ad. 1 Pcs.	C1=L-175
Kanat Cam Yükseklik Glazing Sash Height				1 Ad. 1 Pcs.	C2=H-175

Kesim ölçüsü - cam ölçüsü vb. sorumluluğu tarafımıza ait değildir.

Çizimler Ölçeksizdir.

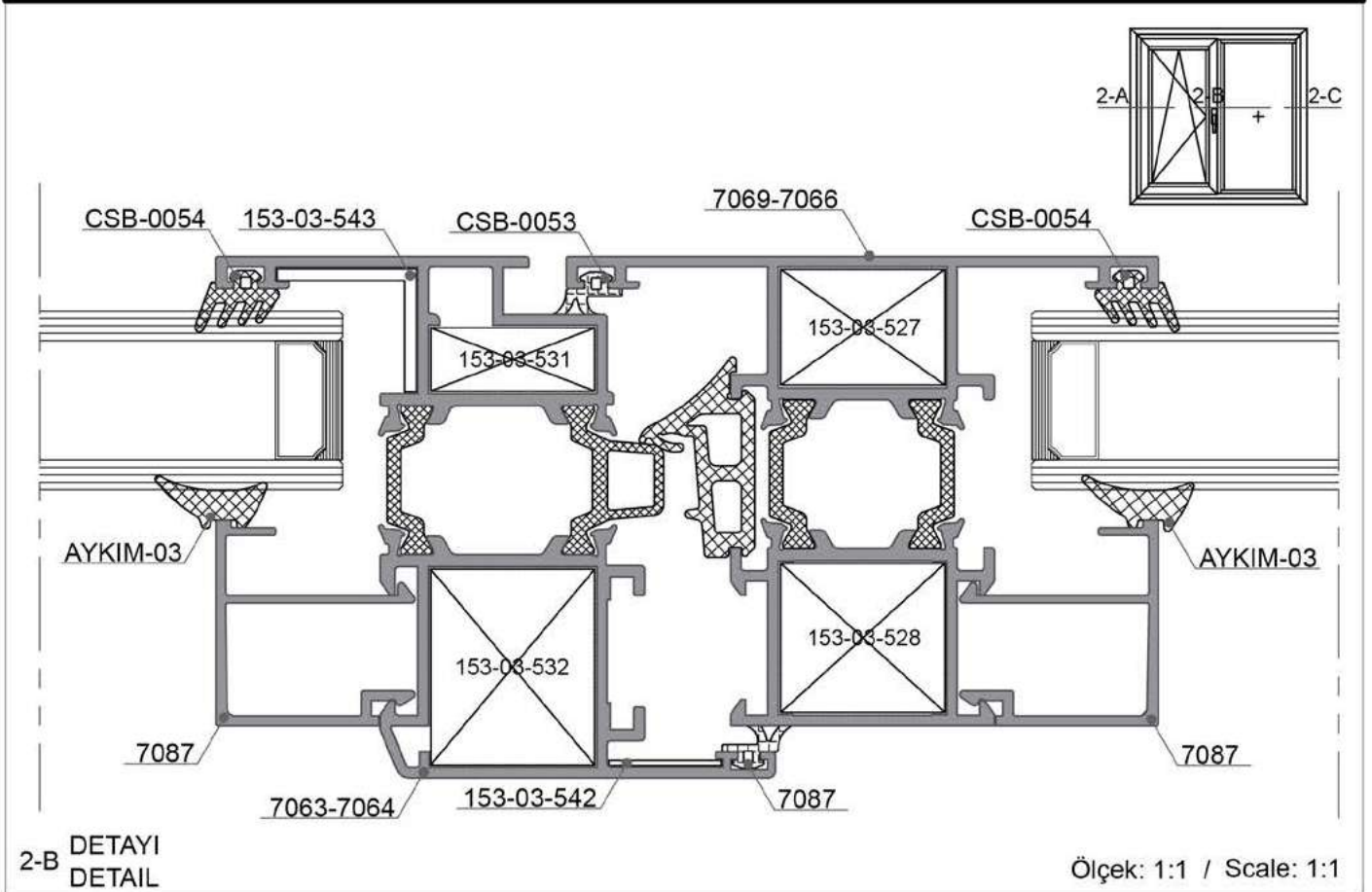
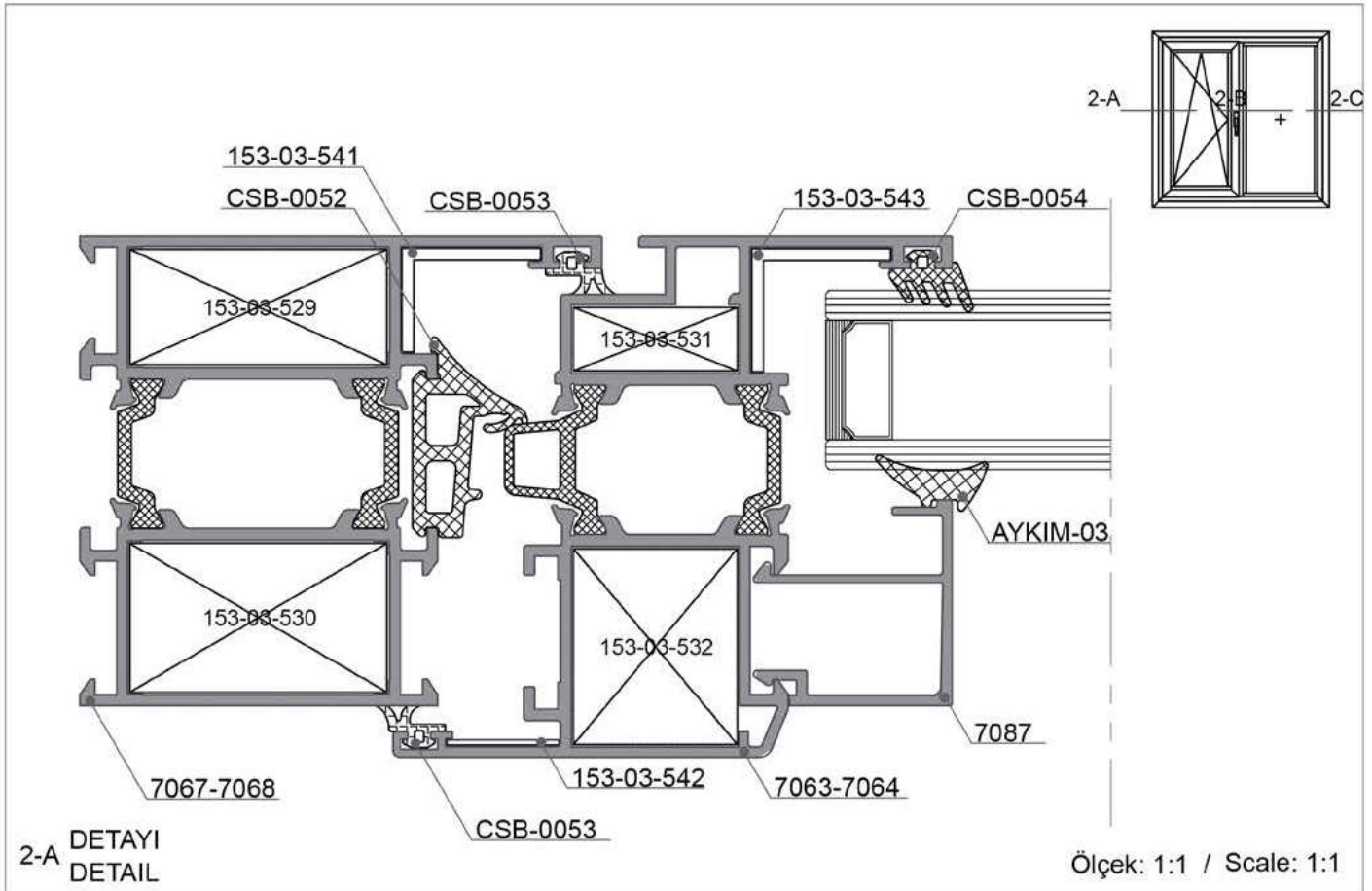

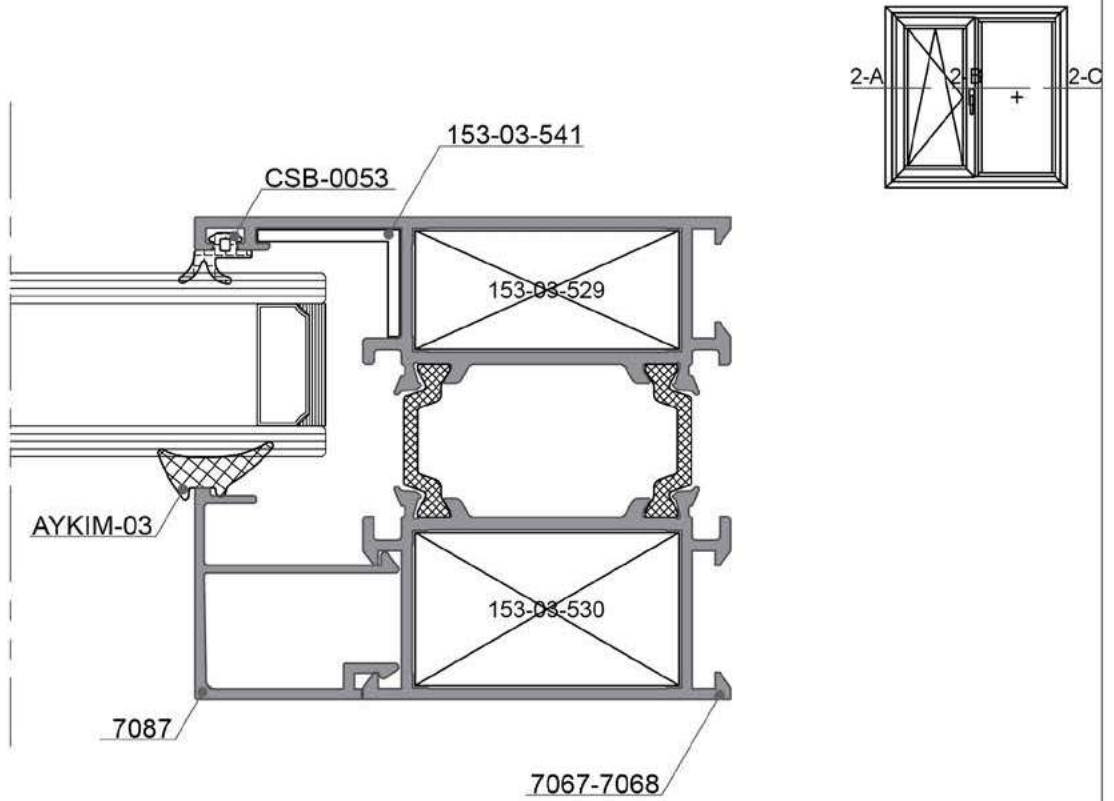
 2-C
 DETAYI
 DETAIL

Ölçek: 1:1 / Scale: 1:1

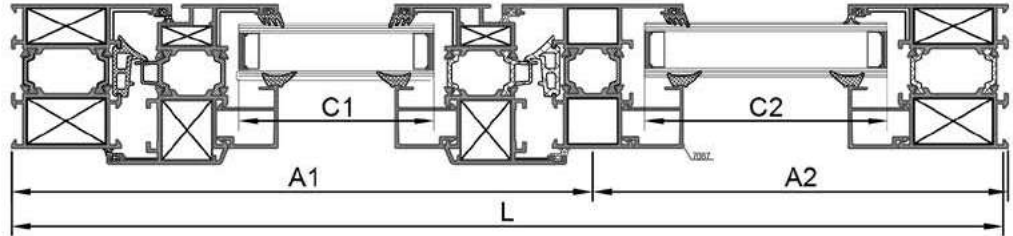
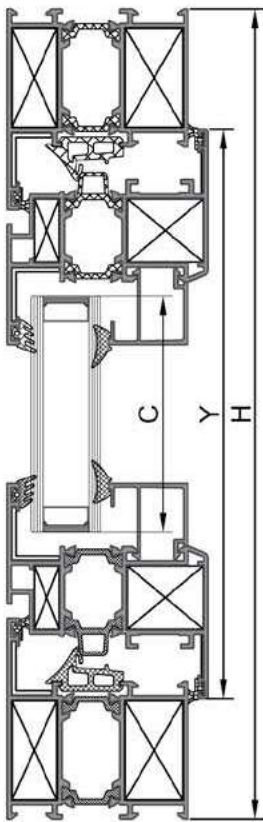

Kasa Genişlik Frame Width	7067-7068			2 Ad. 2 Pcs.	L
Kasa Yükseklik Frame Height	7067-7068			2 Ad. 2 Pcs.	H
Kanat Genişlik Sash Width	7063-7064			2 Ad. 2 Pcs.	A1-53,7
Kanat Yükseklik Sash Height	7063-7064			2 Ad. 2 Pcs.	H-84
Orta Kayıt Yükseklik Mullion Profile Height	7069-7066			1 Ad. 1 Pcs.	H-96
Cam Çita Profili Genişlik-Yükseklik Bead Glazing Profile Width-Height (Kanat / Sash)	7087			2 Ad. 2 Pcs.	A1-160 / H-233,92
Cam Çita Profili Genişlik-Yükseklik Bead Glazing Profile Width-Height (Sabit / Fix)	7087			2 Ad. 2 Pcs.	A2-66 / H-139,92
Kanat Cam Genişlik-Yükseklik Glazing Sash Width- Height				1 Ad. 1 Pcs.	A1-169 / H-200
Sabit Cam Genişlik-Yükseklik Glazing Fix Width-Height				1 Ad. 1 Pcs.	A2-76 / H-106

Kesim ölçüsü - cam ölçüsü vb. sorumluluğu tarafımıza ait değildir.

Çizimler Ölçeksizdir.

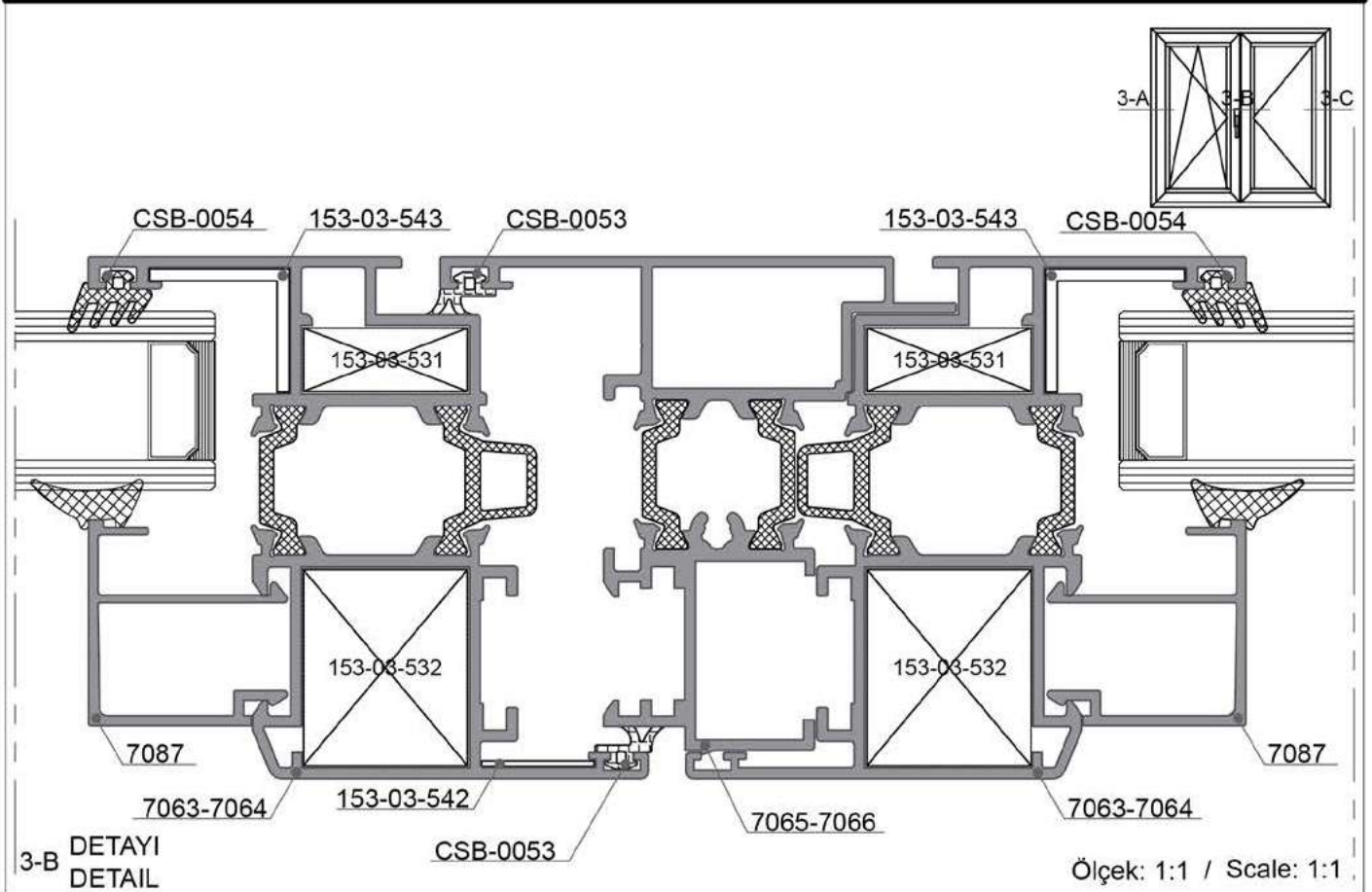
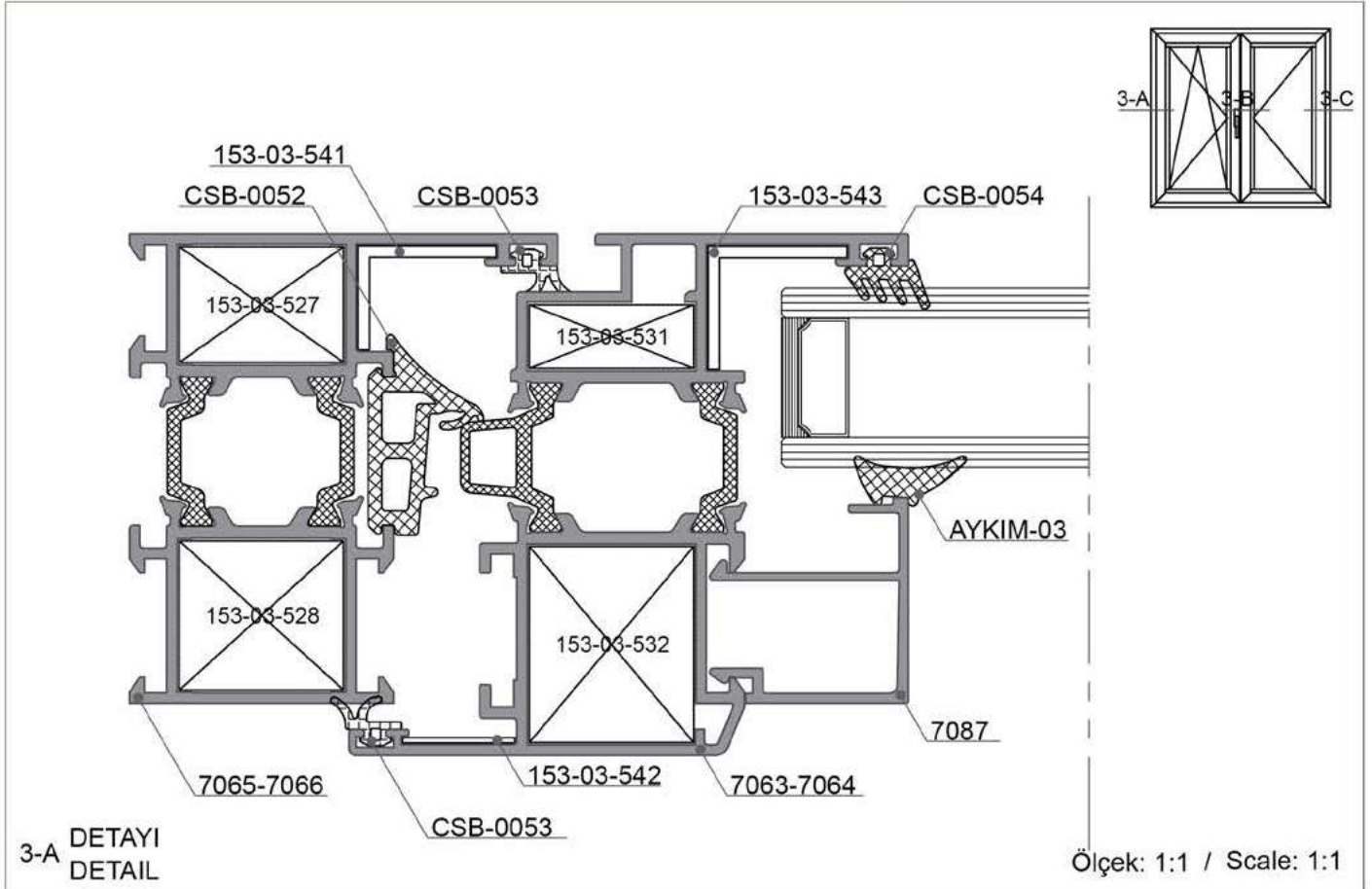

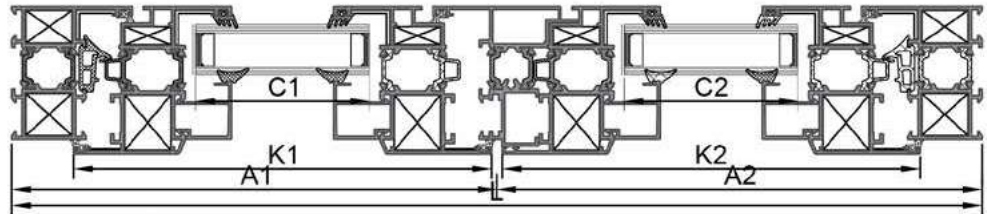
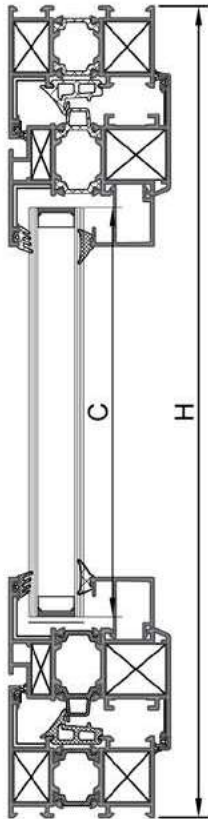
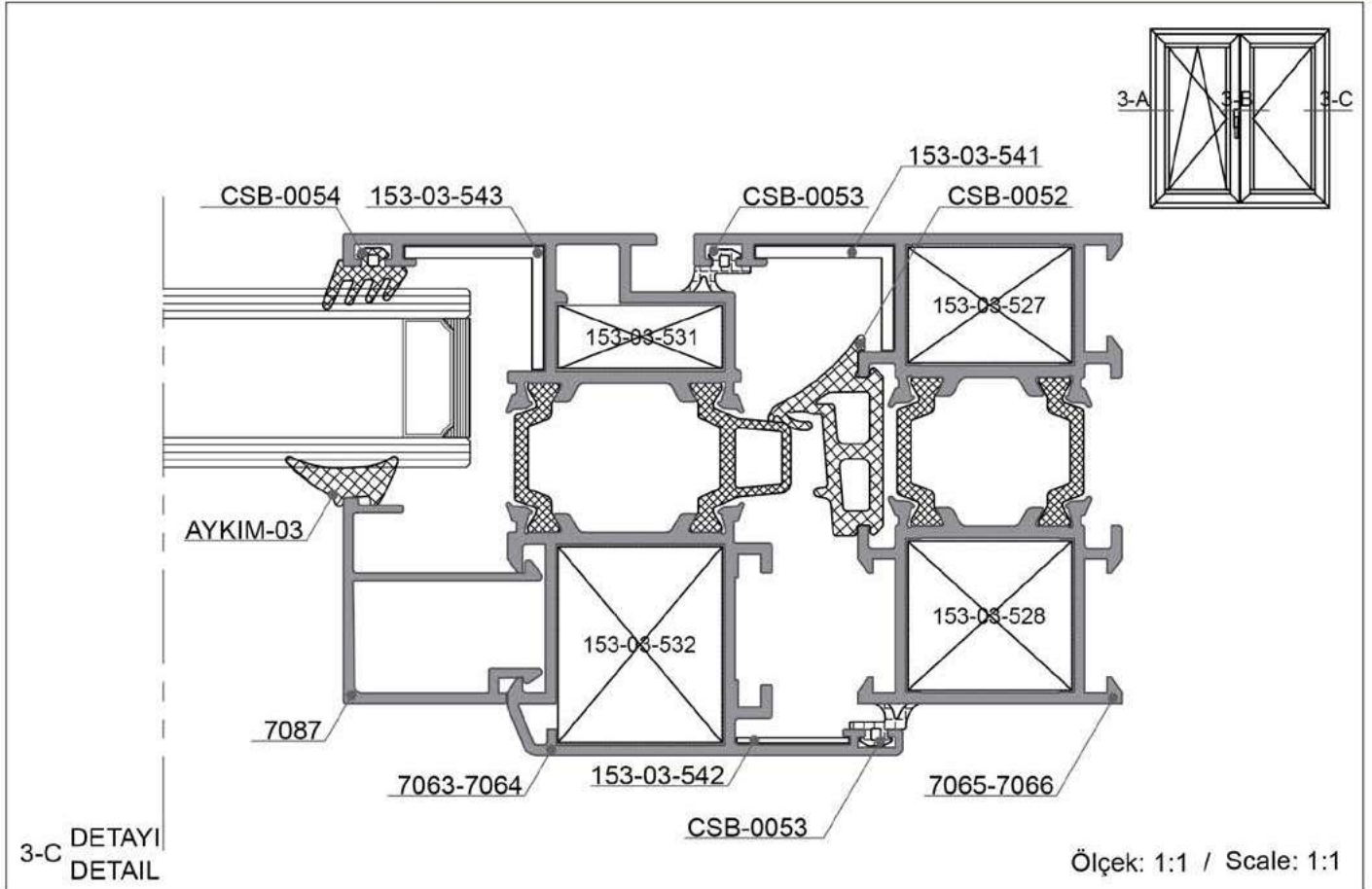

Kasa Genişlik Frame Width	7065-7066			2 Ad. 2 Pcs.	L
Kasa Yükseklik Frame Height	7065-7066			2 Ad. 2 Pcs.	H
1.Kanat Genişlik-Yükseklik 1.Sash Width-Height	7063-7064			2 Ad. / 2 Pcs. 2 Ad. / 2 Pcs.	A1-31,95 H-58,8
2.Kanat Genişlik-Yükseklik 2.Sash Width-Height	7063-7064			2 Ad. / 2 Pcs. 2 Ad. / 2 Pcs.	A2-31,95 H-58,8
Orta Kayıt Yükseklik Mullion Profile Height	7065-7066			1 Ad. 1 Pcs.	H-129,8
Cam Cıta Profili Genişlik-Yükseklik Bead Glazing Profile Width-Height (1.Kanat / 1.Sash)	7087			2 Ad. 2 Pcs.	A1-138,25 H-208,72
Cam Cıta Profili Genişlik-Yükseklik Bead Glazing Profile Width-Height (2.Kanat / 2.Sash)	7087			2 Ad. 2 Pcs.	A2-138,25 H-208,72
1. Kanat Cam Genişlik-Yükseklik Glazing Sash Width-Height				1 Ad. 1 Pcs.	A1-148 / H-175
2. Kanat Cam Genişlik-Yükseklik Glazing Sash Width-Height				1 Ad. 1 Pcs.	A2-148 / H-175

Kesim ölçüsü - cam ölçüsü vb. sorumluluğu tarafımıza ait değildir.

Çizimler Ölçeksizdir.

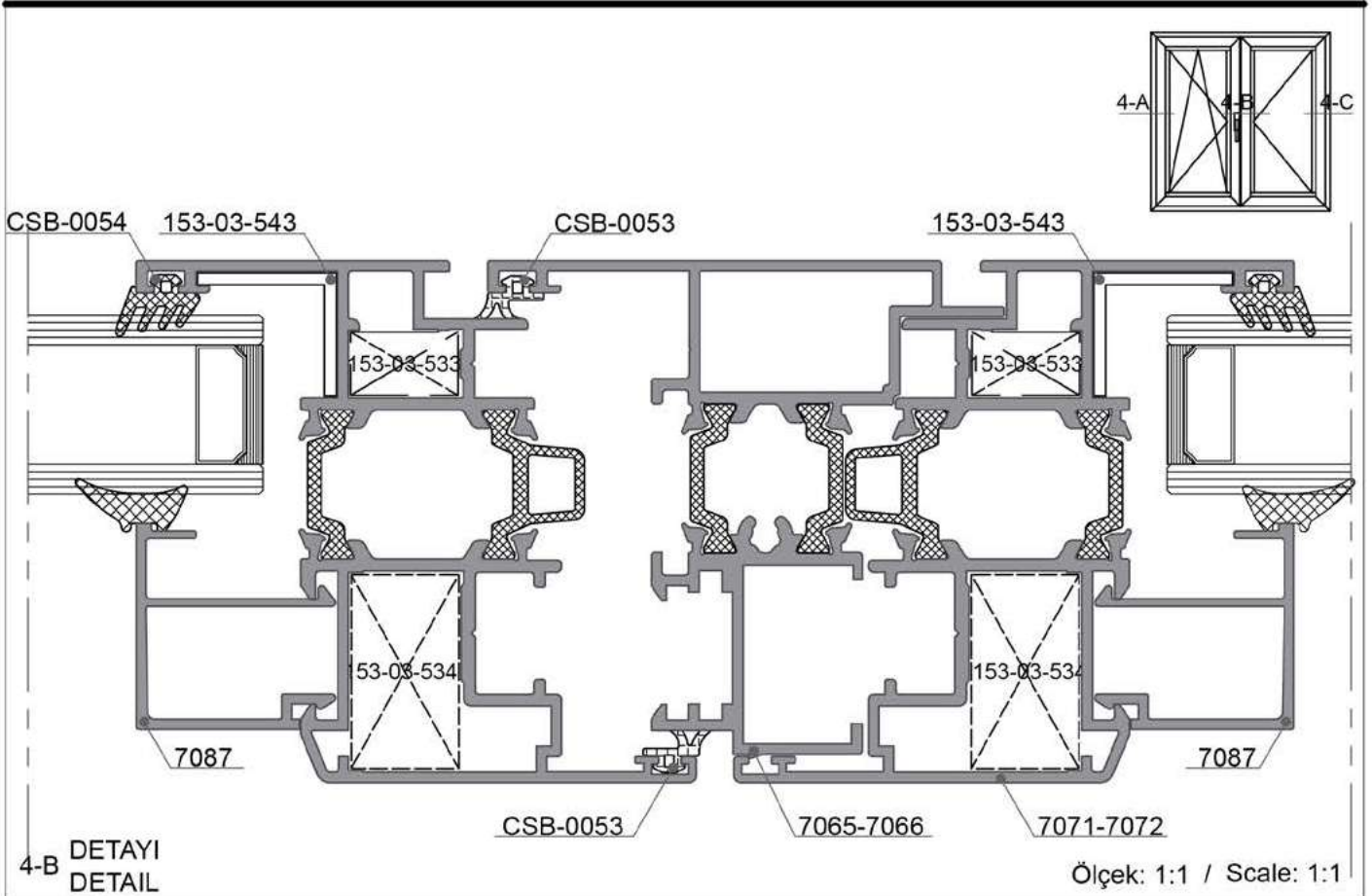
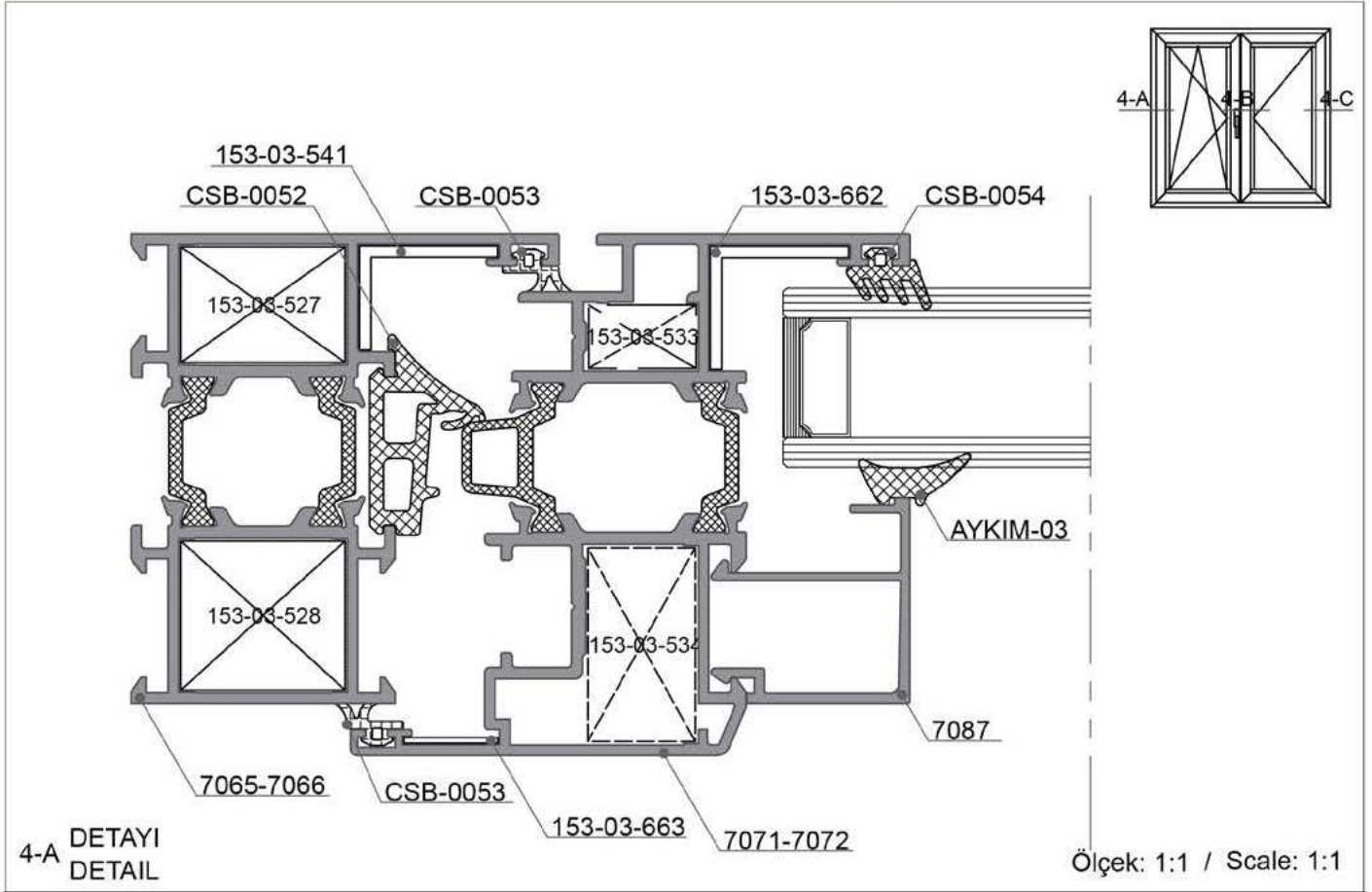

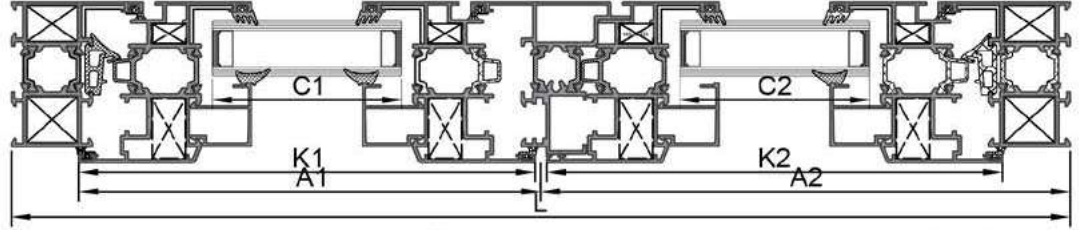
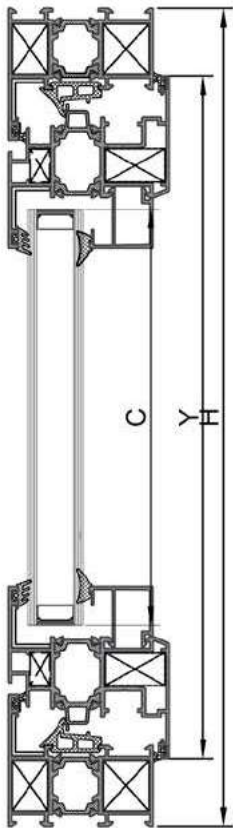
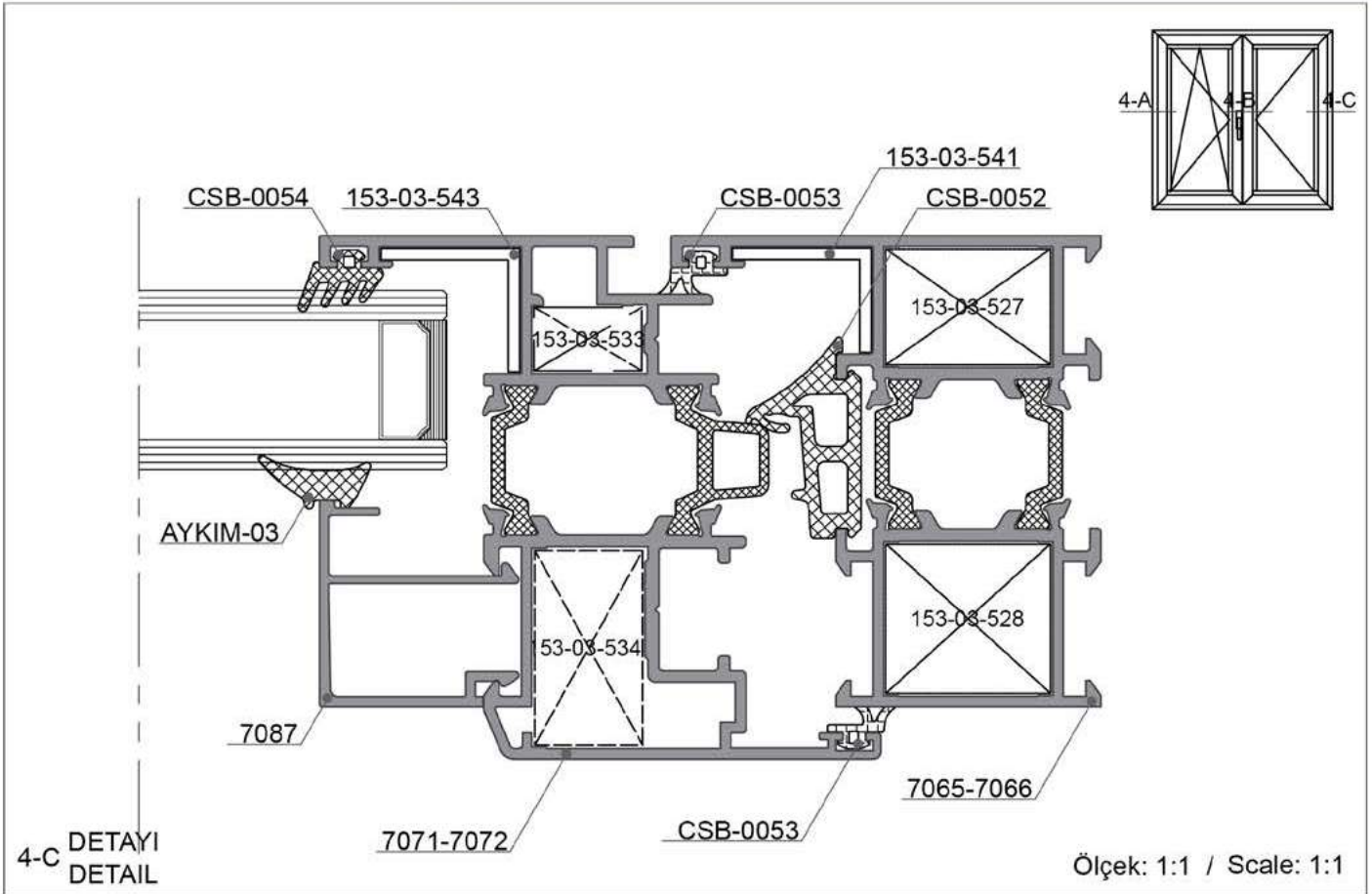

Kasa Genişlik Frame Width	7065-7066			2 Ad. 2 Pcs.	L
Kasa Yükseklik Frame Height	7065-7066			2 Ad. 2 Pcs.	H
1.Kanat Genişlik-Yükseklik 1.Sash Width-Height	7071-7072			2 Ad. / 2 Pcs. 2 Ad. / 2 Pcs.	A1-31,95 H-58,8
2.Kanat Genişlik-Yükseklik 2.Sash Width-Height	7071-7072			2 Ad. / 2 Pcs. 2 Ad. / 2 Pcs.	A2-31,95 H-58,8
Orta Kayıt Yükseklik Mullion Profile Height	7065-7066			1 Ad. 1 Pcs.	H-129,8
Cam Çita Profili Genişlik-Yükseklik Bead Glazing Profile Width-Height (1.Kanat / 1.Sash)	7087			2 Ad. 2 Pcs.	A1-138,25 H-208,72
Cam Çita Profili Genişlik-Yükseklik Bead Glazing Profile Width-Height (2.Kanat / 2.Sash)	7087			2 Ad. 2 Pcs.	A2-138,25 H-208,72
1. Kanat Cam Genişlik-Yükseklik Glazing Sash Width- Height				1 Ad. 1 Pcs.	A1-148 / H-175
2. Kanat Cam Genişlik-Yükseklik Glazing Sash Width- Height				1 Ad. 1 Pcs.	A2-148 / H-175

Kesim ölçüsü - cam ölçüsü vb. sorumluluğu tarafımıza ait değildir.

Çizimler Ölçeksizdir.

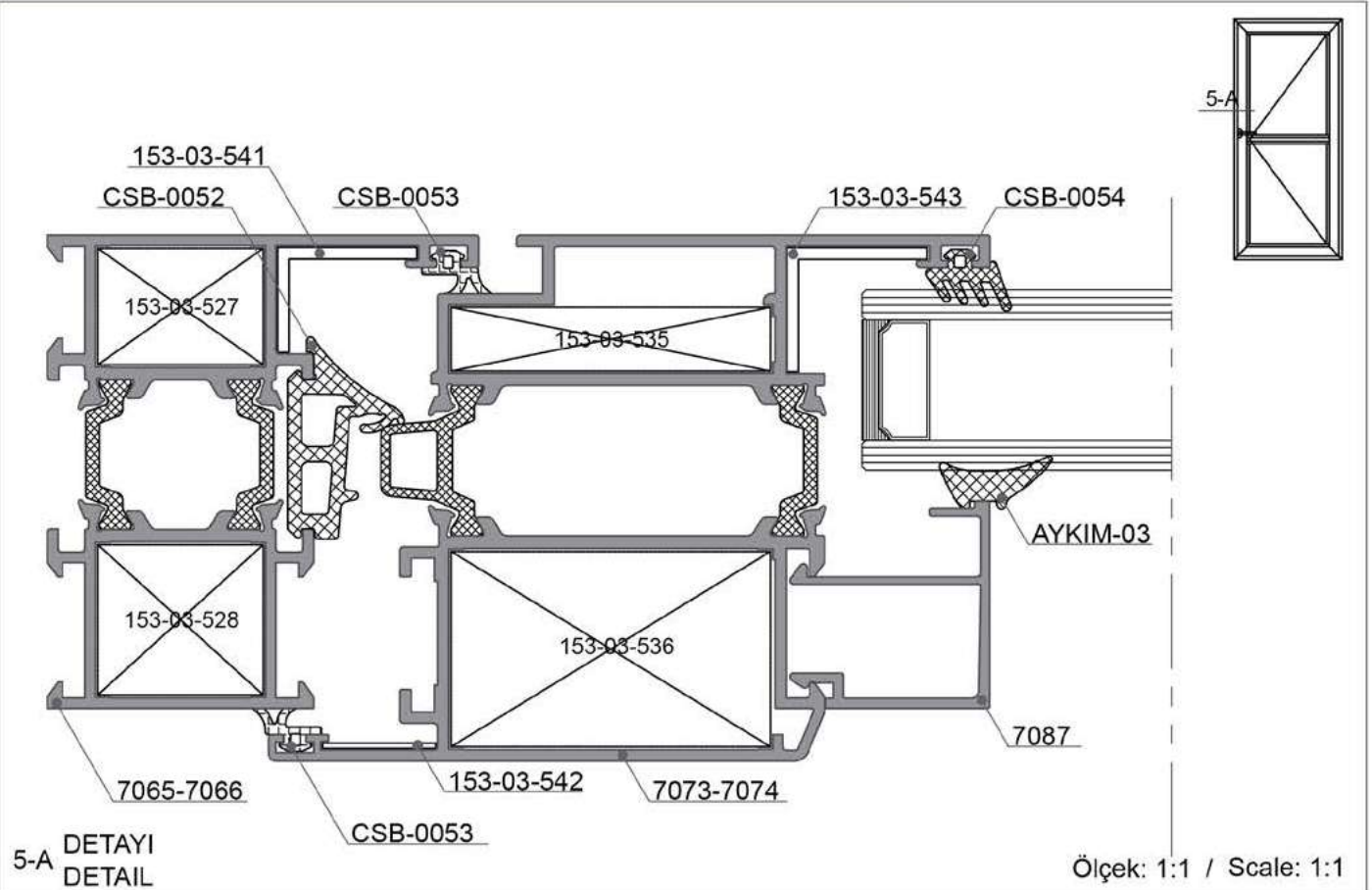
5-A
DETAYI
DETAIL

Ölçek: 1:1 / Scale: 1:1

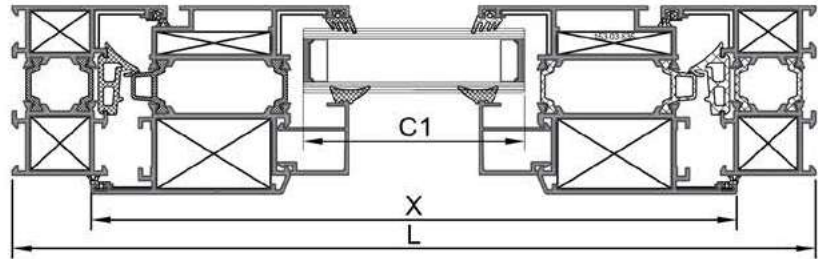
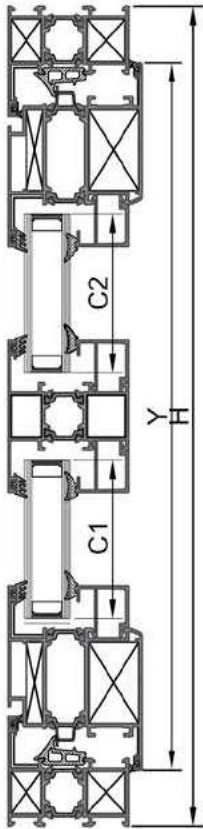

					mm.
Kasa Genişlik Frame Width	7065-7066			2 Ad. 2 Pcs.	L
Kasa Yükseklik Frame Height	7065-7066			2 Ad. 2 Pcs.	H
Kanat Genişlik Sash Width	7073-7074			2 Ad. 2 Pcs.	X= L-58,8
Kanat Yükseklik Sash Height	7073-7074			2 Ad. 2 Pcs.	Y= H-58,8
Orta Kayıt Genişlik Mullion Profile Width	7069-7066			1 Ad. 1 Pcs.	L-207,1
Cam Çita Profili Genişlik Bead Glazing Profile Width	7087			4 Ad. 4 Pcs.	L-207,1
Cam Çita Profili Yükseklik Bead Glazing Profile Height	7087			4 Ad. 4 Pcs.	H/2-165,02
Kanat Cam Genişlik Glazing Sash Width				2 Ad. 2 Pcs.	C1=L-217
Kanat Cam Yükseklik Glazing Sash Height				2 Ad. 2 Pcs.	C2=HX-131,1

Kesim ölçüsü - cam ölçüsü vb. sorumluluğu tarafımıza ait değildir.

Çizimler Ölçeksizdir.

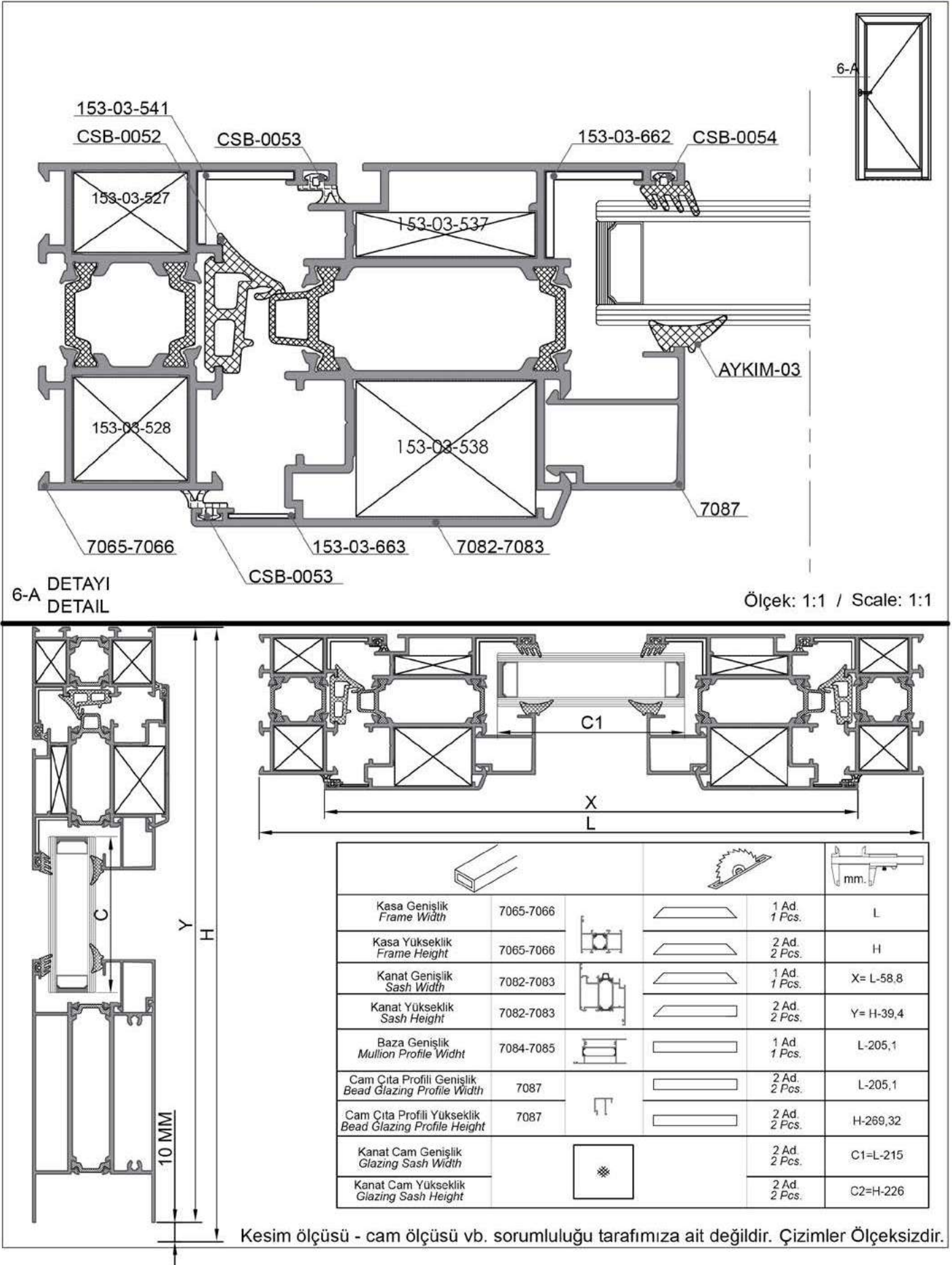

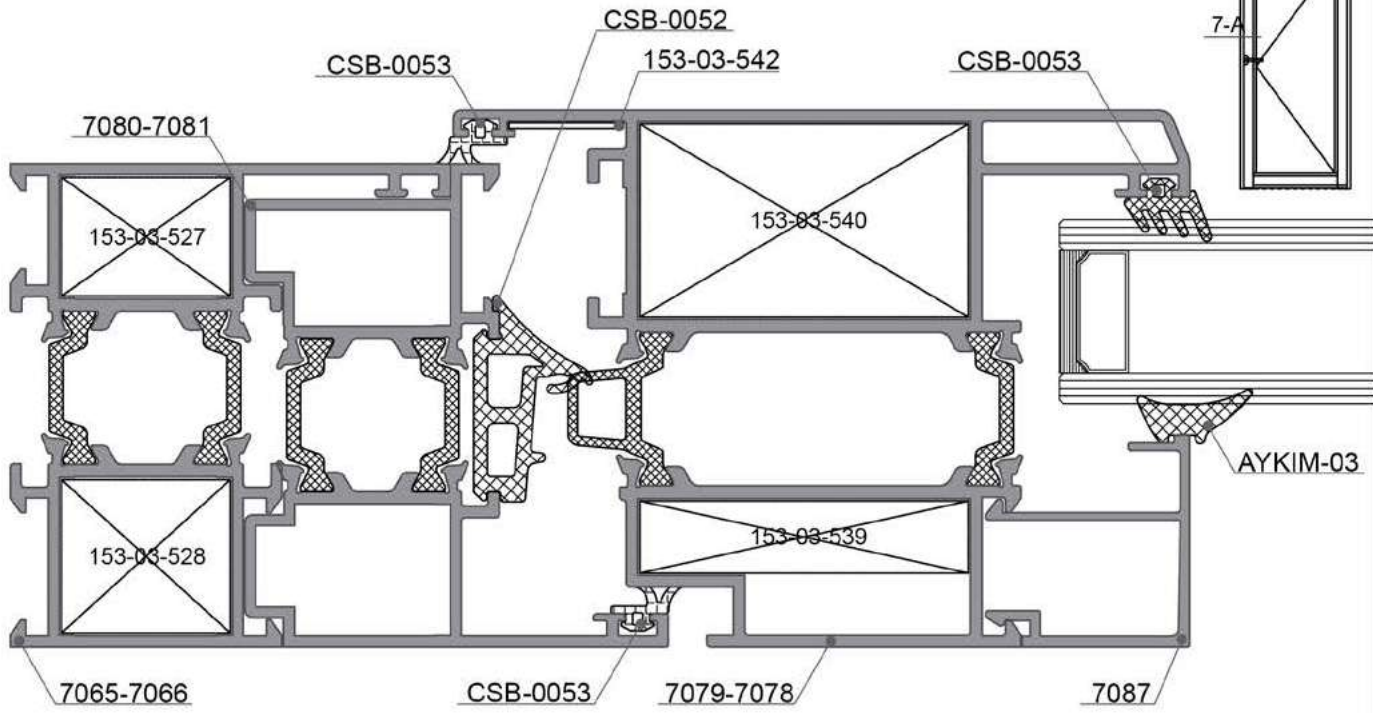
7-A DETAYI
DETAIL

Ölçek: 1:1 / Scale: 1:1

					mm.
Kasa Genişlik Frame Width	7065-7066			2 Ad. 2 Pcs.	L
Kasa Yükseklik Frame Height	7065-7066			2 Ad. 2 Pcs.	H
Kanat Genişlik Sash Width	7079-7088			2 Ad. 2 Pcs.	X= L-115,6
Kanat Yükseklik Sash Height	7079-7088			2 Ad. 2 Pcs.	Y= H-67,8
Adaptör Genişlik Adapter Profile Width	7080-7081			1 Ad. 1 Pcs.	L-61,2
Adaptör Yükseklik Adapter Profile Height	7080-7081			1 Ad. 1 Pcs.	H-40,6
Cam Çita Profili Genişlik Bead Glazing Profile Width	7088			2 Ad. 2 Pcs.	L-263,9
Cam Çita Profili Yükseklik Bead Glazing Profile Height	7088			2 Ad. 2 Pcs.	H-298,76
Kanat Cam Genişlik Glazing Sash Width				2 Ad. 2 Pcs.	C1=L-273,6
Kanat Cam Yükseklik Glazing Sash Height				2 Ad. 2 Pcs.	C2=H-264,8

Kesim ölçüsü - cam ölçüsü vb. sorumluluğu tarafımıza ait değildir. Çizimler Ölçeksizdir.

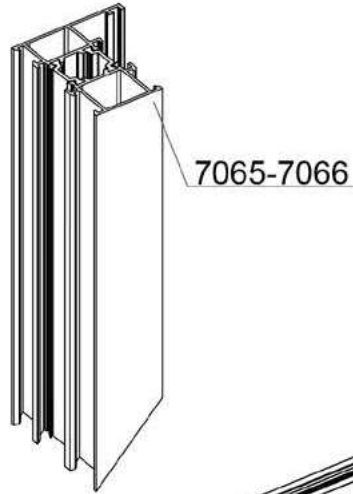
1.
 ADIM

7065-7066

153-03-527

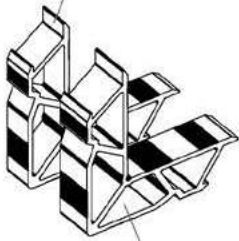

153-03-528

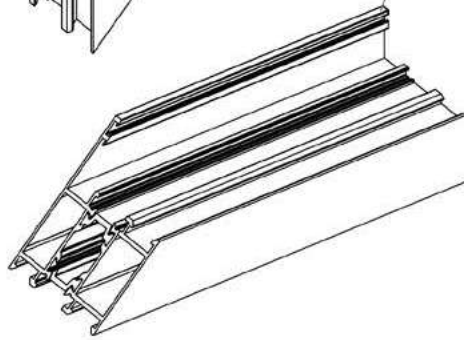
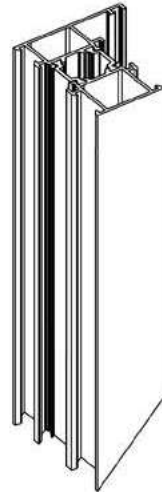
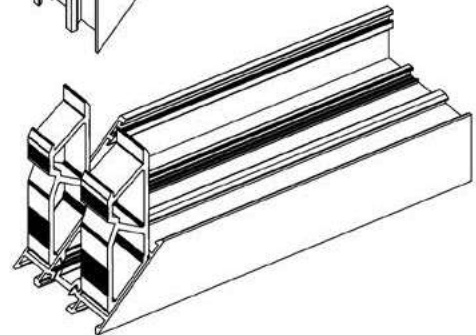
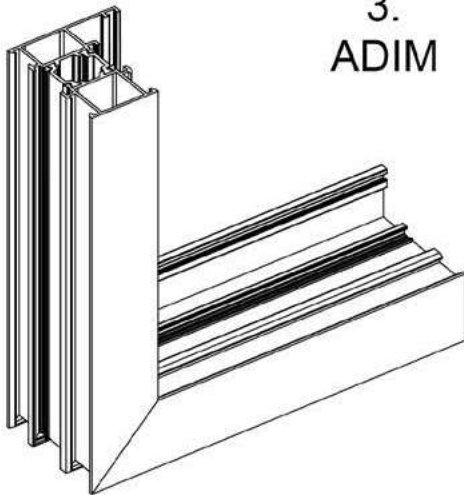
 2.
 ADIM

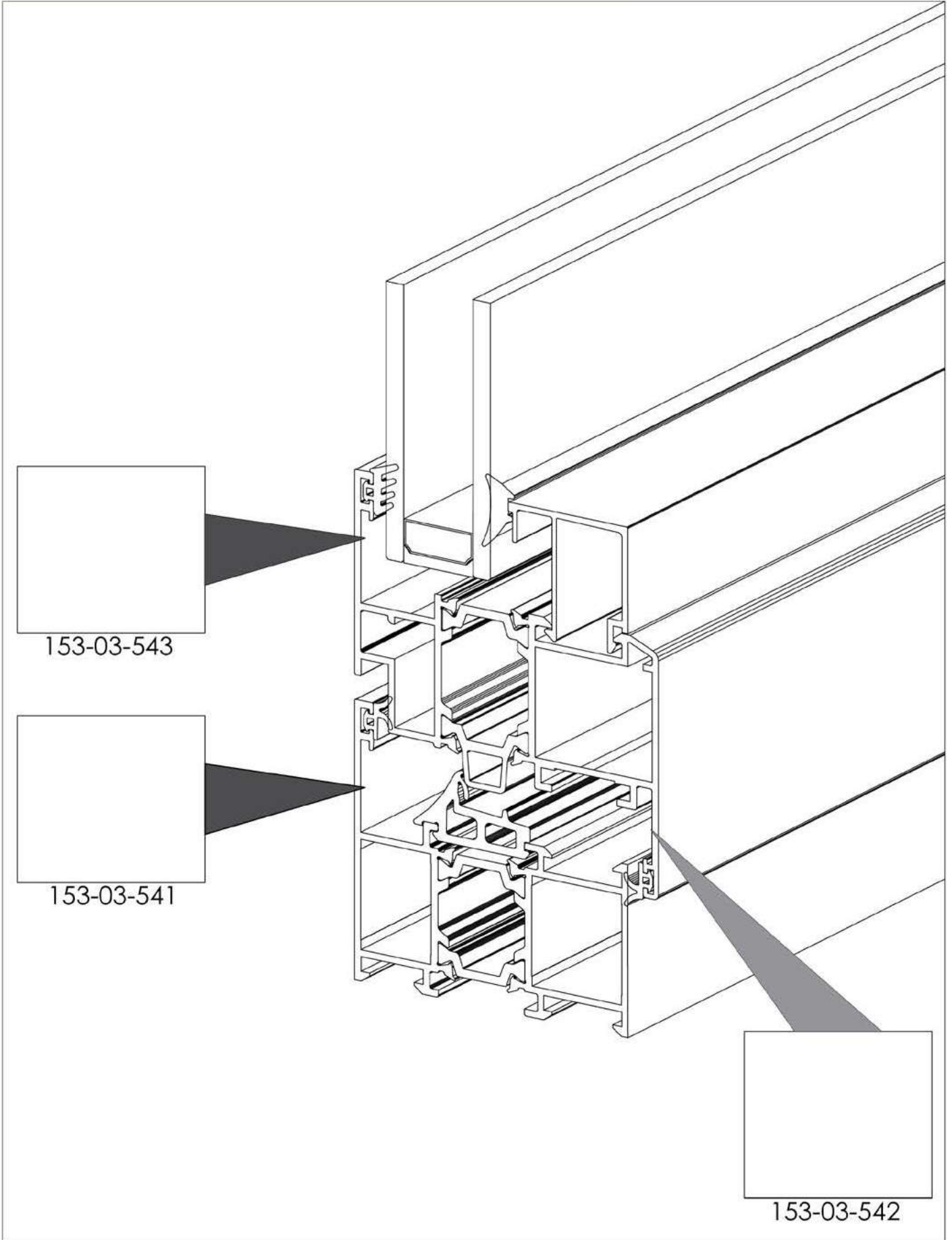
 3.
 ADIM











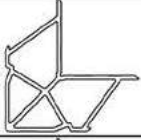
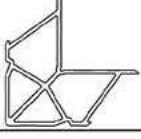



Ürün Çizimi Drawing	Ürün Kodu Product No	Ürün Adı Product Name	Kullanıldığı Profiller Profiles Used
	153-03-533	7102 (14,4 mm) / 8,5mm Joint Corner	7071-7072
	153-03-534	7102 (14,4 mm) / 26mm Joint Corner	7071-7072
	153-03-531	7103 (22 mm) / 8,5mm Joint Corner	7063-7064
	153-03-527	7103 (22 mm) / 15,5mm Joint Corner	7065-7066 7069-7066
	153-03-528	7103 (22 mm) / 20mm Joint Corner	7065-7066 7069-7066
	153-03-532	7103 (22 mm) / 26,3mm Joint Corner	7063-7064
	153-03-537	7104 (34,5 mm) / 8,5mm Joint Corner	7082-7083
	153-03-529	7104 (34,5 mm) / 15,5mm Joint Corner	7067-7068 7070-7068
	153-03-530	7104 (34,5 mm) / 20mm Joint Corner	7067-7068 7070-7068
	153-03-538	7104 (34,5 mm) / 26mm Joint Corner	7082-7083
	153-03-535	7105 (42,5 mm) / 8,5mm Joint Corner	7073-7074
	153-03-536	7105 (42,5 mm) / 26mm Joint Corner	7073-7074

Aksesuarlar / Accessories

WD52

COSABELLA®
 innovative aluminum solutions

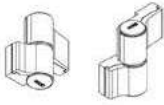







Ürün Çizimi Drawing	Ürün Kodu Product No	Ürün Adı Product Name	Kullanıldığı Profiller Profiles Used
	153-03-539	7105 (42,5 mm) / 9,4mm Joint Corner	7079
	153-03-540	7105 (42,5 mm) / 25,2mm Joint Corner	7078
	153-03-661	CSB WD-52 Plastik Orta Kayıt Takozu T Profile Joint Cleats	
	153-03-541	CSB WD-52 Kasa Köşe Gönye Alignment Square	
	153-03-542	CSB WD-52 Kanat Köşe Gönye (iç) Alignment Square (interior)	
	153-03-543	CSB WD-52 Kanat Köşe Gönye (dış) Alignment Square (exterior)	
	153-03-662	CSB WD-52 PVC Kanallı Pencere Köşe Gönye (iç)	
	153-03-663	CSB WD-52 PVC Kanallı Pencere Köşe Gönye (dış)	
	153-03-664	CSB WD-42 /WD-52 Ayarlı Dilli Kapı Kilit Karşılığı (SİYAH)	
	153-03-665	CSB WD-42 /WD-52 Ayarlı Makaralı Kapı Kilit Karşılığı (SİYAH)	
	153-01-276	İTALYAN SÜRGÜ (RENKLİ)	
	153-03-660	CSB WD-52 Hareketli Orta Kayıt Adaptör Tapası	

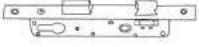
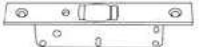





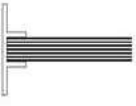

Ürün Çizimi Drawing	Ürün Kodu Product No	Ürün Adı Product Name	Kullanıldığı Profiller Profiles Used
	153-03-565	Stac Smart Çift Açılım Makas (XS 345-700)	
	153-03-569	Stac Smart Çift Açılım Makas (XL 701-1200)	
	153-03-566	Stac Smart Çift Açılım Köşe Hareket İletim ve Dikey Kilitleme Grubu	
	153-03-567	Stac Smart Çift Açılım Aktif Kanat Mentеше Tkm. (90kg) Hinges For Active Sash	
	153-03-568	Stac Smart Çift Açılım Ayarlı Karşılık Tilt & Turn Adjustable Locking Point	
	153-03-986	Stac Sirius Eksenel Kol Siyah	
	153-03-571	Stac Smart Çift Açılım İlave Kilitleme Kiti	
	153-03-572	Stac Smart Çift Açılım İlave Makas	
	153-03-573	Stac Smart Çift Açılım Arka Kitleme Seli Supplementary Corner Drive Set	
	153-03-570	Stac Norma Fast 2 Pano Mentеше Siyah	
	153-01-259	Sistem Tij Pimi System Transmission Rod Rivet	
	153-01-356	Polyamid Tij Polyamide Transmission Rod	







Aksesuarlar / Accessories













WD52

COSABELLA®
 innovative aluminum solutions

Ürün Çizimi Drawing	Ürün Kodu Product No	Ürün Adı Product Name	Kullanıldığı Profiller Profiles Used
	153-01-088	Sistem Makas Renkli Transom Window Color	
	153-01-326	153 / 25 U Boş Kasa Kale Dilli Kilit Mortise Lock	
	153-01-026	155 / 25 U Boş Kasa Kale Makaralı Kilit Roller Lock	
	153-01-032	76 mm Barel 76 mm Cylinders	
	153-03-418	Stac Sirius Kapı Kolu Stac Sirius Door Handle (Siyah-Black)	
	153-03-419	Stac Sirius Barel Rozeti Stac Sirius Cylinder Cover Plate (Siyah-Black)	
	153-01-192-D	Sistem Dilli Kilit Karşılığı (renkli) Locking Keeper (Color)	
	153-01-192-M	Sistem Makaralı Kilit Karşılığı (renkli) Keeper Locking Roller (Color)	
	153-01-154	Yay Kol 60cm Bow Handle (renkli,color)	
	153-03-742	Akbank Kol Borusu + Aparat Tkm. Akbank Sleeve Pip + Apparatus	
	153-01-301 153-01-304 153-01-307	Kıvrık Kol Curved Sleeve 20cm/30cm/40cm (renkli)	
	153-01-023	Kapı Altı Alüminyum Fırça Aluminium Brush for Doors	







Ürün Çizimi Drawing	Ürün Kodu Product No	Ürün Adı Product Name	Kullanıldığı Profiller Profiles Used
	FBSL0010-100060 TBEL6150-100070	Kasa Üst Menteşe Kasa Alt Menteşe	
	FBSB0010-100060	Kasa Üst Menteşe Pimi	
	FBWB1020-100050	Kasa Üst Menteşe Aks	
	TBFE1011-100054 TBFE1012-100054	Kanat Alt Menteşe Sağ/Sol	
		Kanat Üst Menteşe Sağ/Sol	
		Kanat Alt Menteşe Kapağı	
		Kasa Alt-Üst Menteşe Kapağı	
		Üst Menteşe Orta Kapak	
		Köşe Elemanı Üst Emniyetli	
		Köşe Elemanı Alt Emniyetli	
		Çift Açılır İspanyolet / İspanyolet Karşılığı	
		Tek açılır ispanyolet / ispanyolet karşılığı	

Ürün Çizimi Drawing	Ürün Kodu Product No	Ürün Adı Product Name	Kullanıldığı Profiller Profiles Used
	153-02-789	Tahliye Tapası Drainage Hole Cover	
	FRKA0270-100060	Alt devrilme Karşılığı	
	153-01-129	Sistem Zaman Karşılığı	
	153-01-102	Vasistas Çarpma Transom Window Lock (Renkli-Color)	
	CSB-0053	Kanat Bini Fitili Accoustical Gasket for Sash	
	CSB-0052	WD52 Orta Tozluk Fitili Middle Brush	
	AYKIM-03	Glazing Wedge Gasket (Cam Tercihine Göre) (Optional Glass Size)	
	CSB-0054	Dış Cam Fitili Outer Window Wick	

Profil Profile	Profil Kodu Profile Nr	Ağırlık (kg/m.) Weight (kg/m.)	X mm.	Y mm.	Jx cm ⁴	Jy cm ⁴	TAKOZ
	7065-7066	1,303kg/mt	63 mm	57,4 mm	21,98	9,03	7103 (22mm) / 15,5mm 7103 (22mm) / 20mm
	7067-7068	1,546kg/mt	63 mm	70 mm	26,28	15,58	7104 (34,5mm) / 15,5mm 7104 (34,5mm) / 20mm
	7063-7064	1,484kg/mt	70 mm	75 mm	33,16	9,87	7103 (22mm) / 8,5mm 7103 (22mm) / 26,3mm
	7071-7072	1,533kg/mt	70 mm	75 mm	33,73	9,58	7102 (14,4mm) / 8,5mm 7102 (14,4mm) / 26mm
	7073-7074	1,895kg/mt	70 mm	96 mm	48,62	26,50	7105 (42,5mm) / 8,5mm 7105 (42,5mm) / 26mm
	7069-7066	1,439kg/mt	62,98 mm	79,4 mm	23,20	13,06	7103 (22mm) / 15,5mm 7103 (22mm) / 20mm
	7070-7068	1,645kg/mt	63 mm	92 mm	27,18	23,32	7104 (34,5mm) / 15,5mm 7104 (34,5mm) / 20mm
	7075-7076	1,322kg/mt	69,2 mm	66,75 mm	20,48	8,22	
	7079-7078	1,862kg/mt	70 mm	96 mm	38,07	34,77	
	7080-7081	1,228kg/mt	63 mm	55,2 mm	18,11	6,51	
	7082-7083	1,909kg/mt	70 mm	95 mm	50,04	26,43	7104 (34,5mm) / 8,5mm 7104 (34,5mm) / 26mm
	7085-7084	2,876kg/mt	135 mm	63,3 mm	117,65	51,52	

SD22
SD23
SD32
SD33
SD35
WD42
WD52
FS72

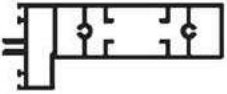
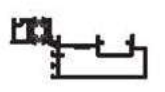
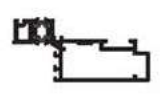
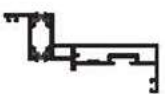
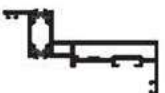
FS72

Profil Profile	Profil Kodu Profile Nr	Ağırlık (kg/m.) Weight (kg/m.)	X mm.	Y mm.	Jx cm ⁴	Jy cm ⁴
	6800	2,815	142,5 mm	55 mm	198,44	11,83
	6801	2,478	141,25 mm	55 mm	168,46	12,83
	6966	3,159	165 mm	55 mm	305,47	12,27
	7188	2,528	142,5 mm	55 mm	189,05	22,75
	7189	2,810	131,65 mm	55 mm	198,75	23,91
	6803-6802	1,507	87,38 mm	38,9 mm	37,71	4,12
	6803-7200	1,446	87,38 mm	40,62 mm	36,62	4,60
	6805-6804	1,676	98,77 mm	51,5 mm	51,74	3,79
	6805-7201	1,675	98,77 mm	54,6 mm	54,19	3,99
	6960	0,434	55 mm	8 mm		
	6961	0,483	55 mm	26 mm		

Düşey Orta Profil - Vertical Middle Profile

6800

2,815 kg/mt

Düşey Orta Profil

6966

3,159 kg/mt

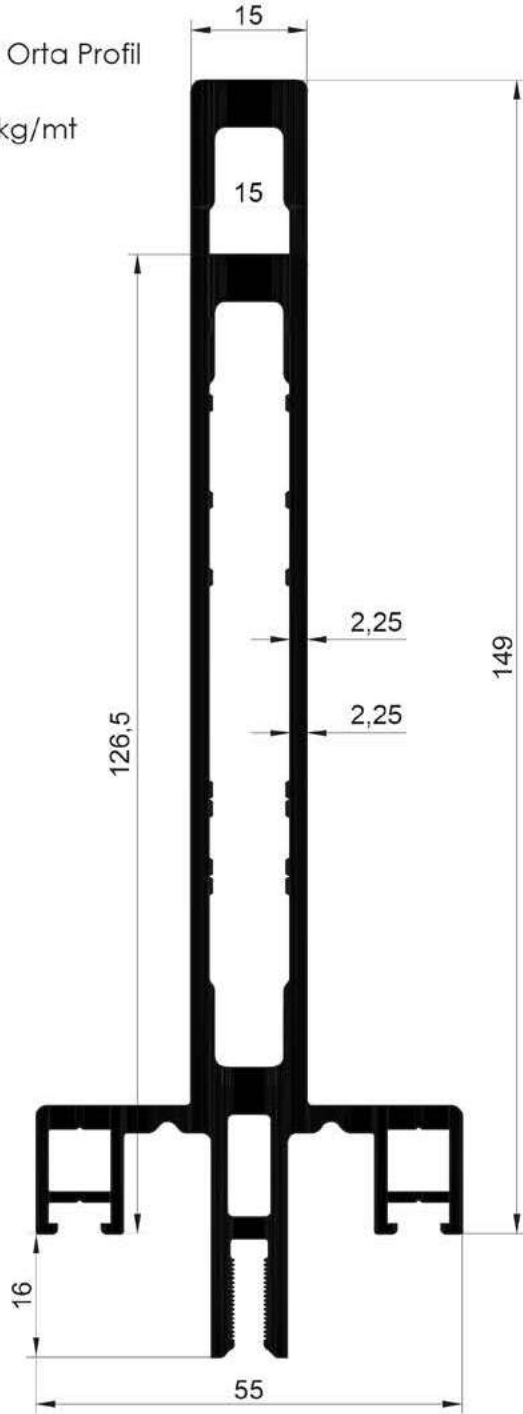
6800
6966

Yatay Orta Profil - Horizontal Middle Profile

6801

2,478 kg/mt

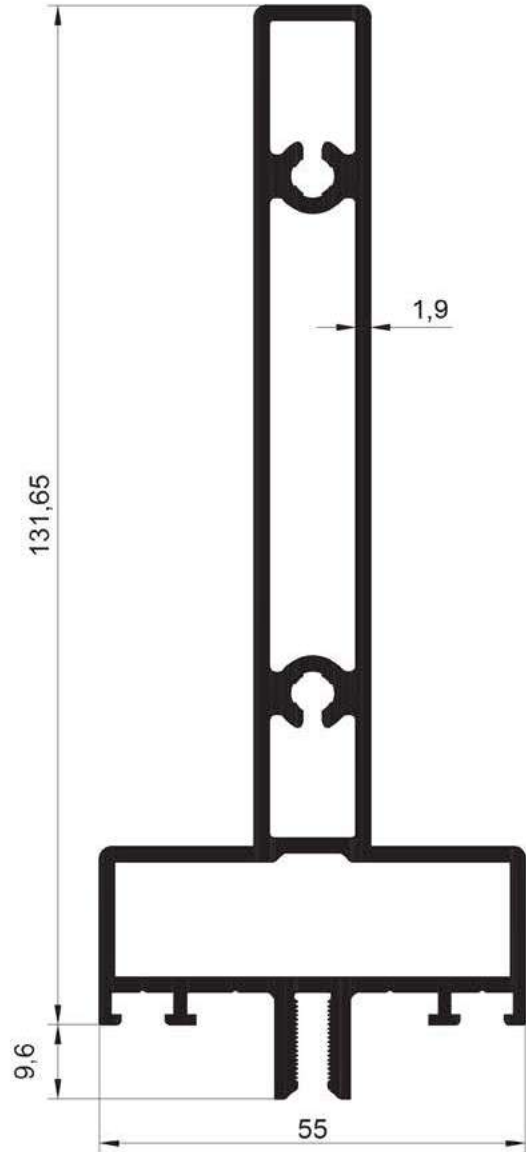
6801

Kod/Code	Et Kalın./Wall Thk.	Ürün Adı / Prod. Name	Ağırlığı /Weight	Köşe Takozu / C. Cleat
6800	2,25 mm	Düşey Orta Profil / Vertical Middle Profile	2,815 kg/mt	-
6966	2,25 mm	Düşey Orta Profil / Vertical Middle Profile	3,159 kg/mt	-
6801	1,9 mm	Yatay Orta Profil / Horizontal Middle Profile	2,478 kg/mt	-

Düşey Bitiş Profili - Vertical End Profile

7188

2,528 kg/mt

Yatay Bitiş Profil - Horizontal End Profile

7189

2,810 kg/mt

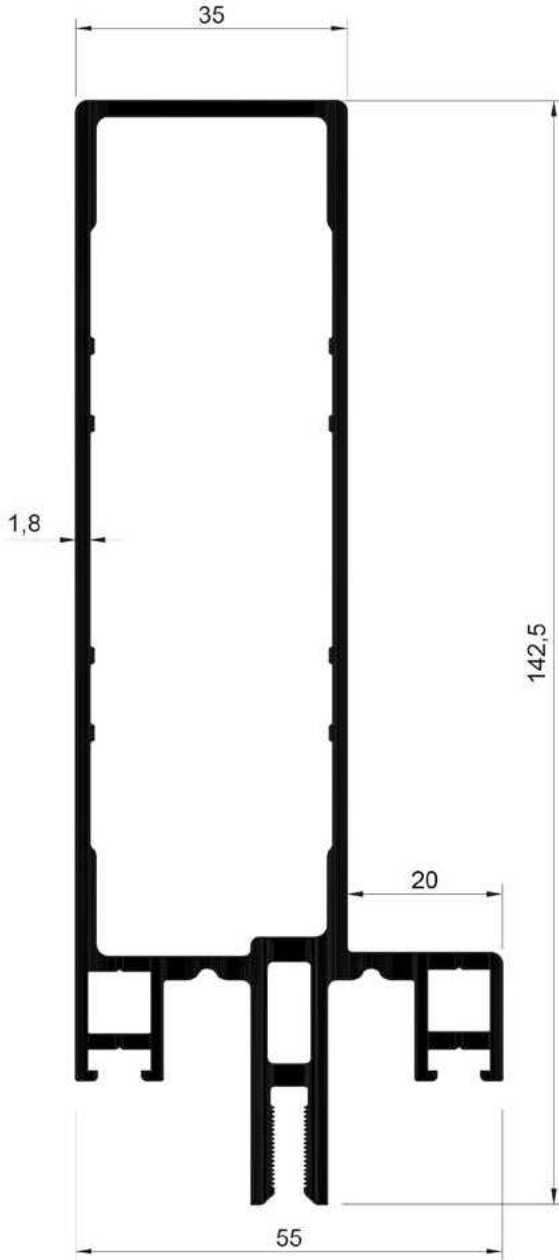

7188

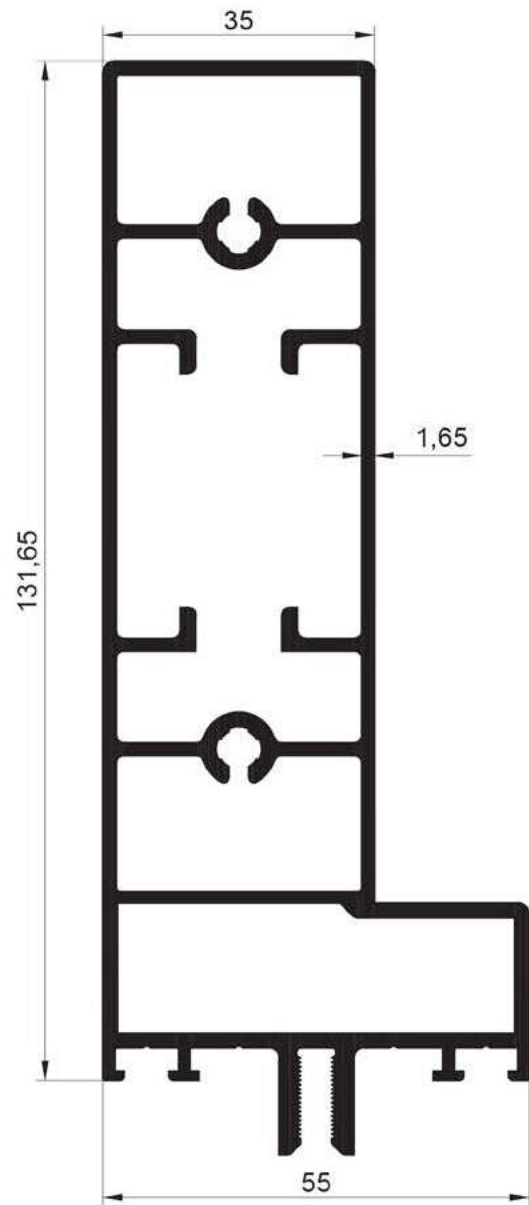

7189

Kod/Code	Et Kalın./Wall Thk.	Ürün Adı / Prod. Name	Ağırlığı /Weight	Köşe Takozu / C. Cleat
7188	1,8 mm	Düşey Bitiş Pr. / Vertical End Profile	2,528 kg/mt	-
7189	1,9 mm	Yatay Bitiş Pr. / Horizontal End Profile	2,810 kg/mt	-

Gizli Kasa Profili - Frame Profile

6805-6804

1,676 kg/mt

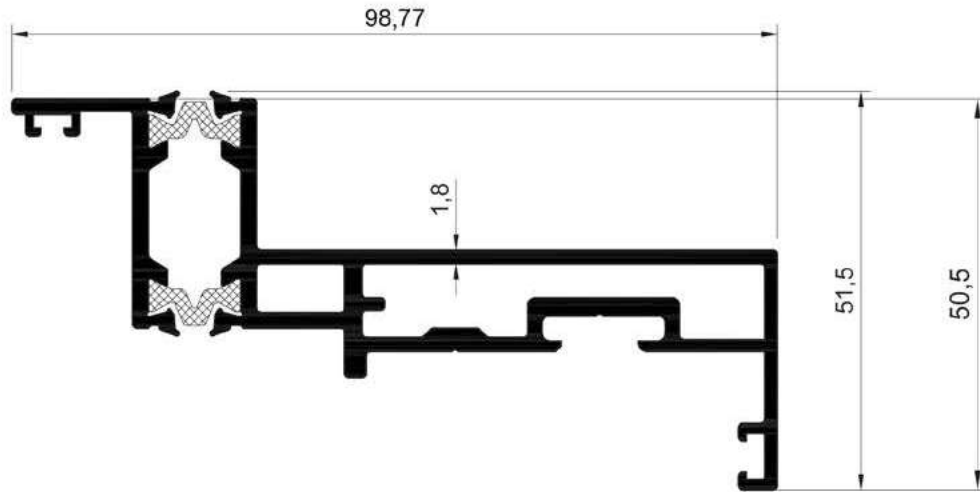

6805-6804

Kod/Code	Et Kalın./Wall Thk.	Ürün Adı / Prod. Name	Ağırlığı /Weight	Köşe Takozu / C. Cleat
6805-6804	1,8 mm	Gizli Kasa Profili / Concealed Frame Profile	1,676 kg/mt	-

Gizli Kasa Profili - Frame Profile

6805-7201

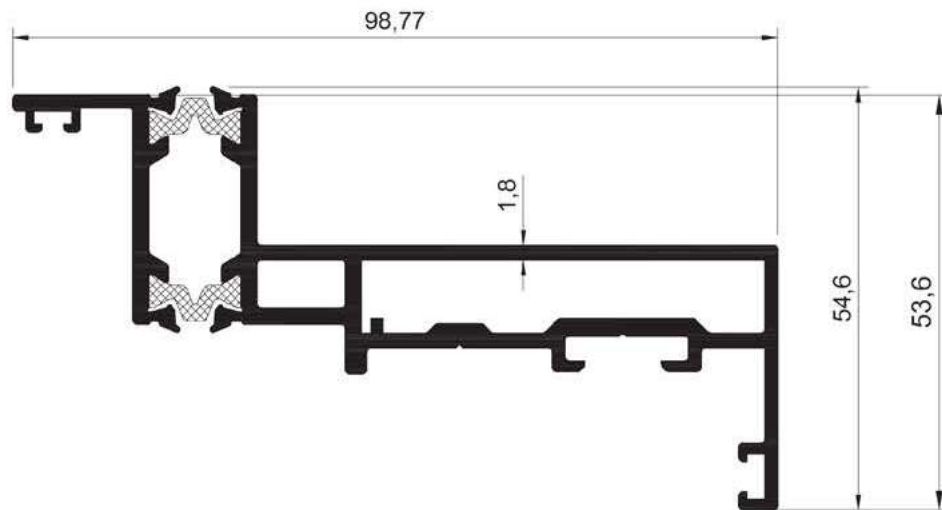
1,675 kg/mt



6805-7201

Kod/Code	Et Kalın./Wall Thk.	Ürün Adı / Prod. Name	Ağırlığı /Weight	Köşe Takozu / C. Cleat
6805-7201	1,8 mm	Gizli Kasa Profili / Concealed Frame Profile	1,675 kg/mt	-

D. Kapak Profili - Vert. Cap Profile

6961

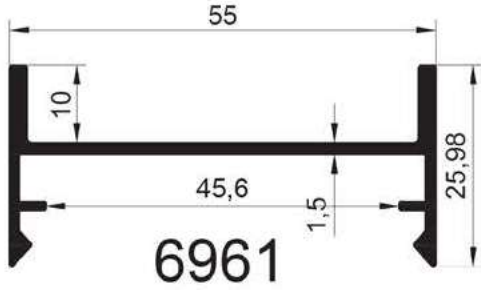
0,483 kg/mt



6961

Y.Kapak Profili - H. Cap Profile

6962

0,361 kg/mt

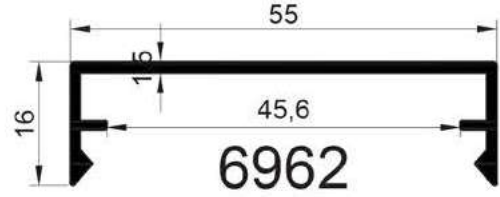

6962

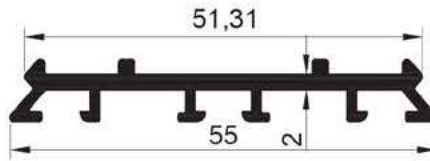

6960

Alt Kapak Profili - Low. Cap Profile

6960 0,434 kg/mt

Kod/Code	Et Kalın./Wall Thk.	Ürün Adı / Prod. Name	Ağırlığı /Weight	Köşe Takozu / C. Cleat
6961	1,5 mm	D. Kapak Profili - Vert. Cap Profile	0,483 kg/mt	-
6962	1,5 mm	Y.Kapak Profili - H. Cap Profile	0,361 kg/mt	-
6960	2 mm	Alt Kapak Profili - Low. Cap Profile	0,434 kg/mt	-

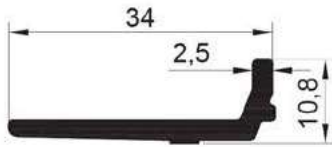

6806

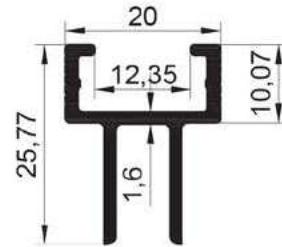

6807

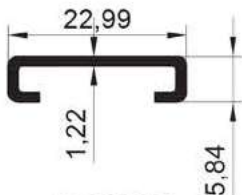

6809



6810

Kod/Code	Et Kalın./Wall Thk.	Ürün Adı / Prod. Name	Ağırlığı /Weight	Köşe Takozu / C. Cleat
6806	2,5 mm	-	0,269kg/mt	-
6809	1,2 mm	-	-	-
6807	1,6 mm	-	0,301 kg/mt	-
6810	1,6 mm	-	0,097 kg/mt	-

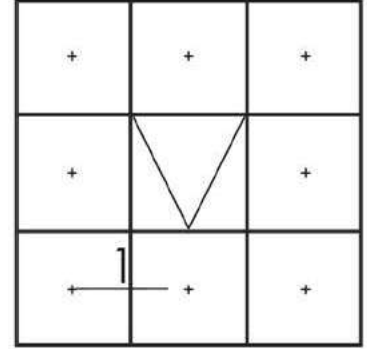
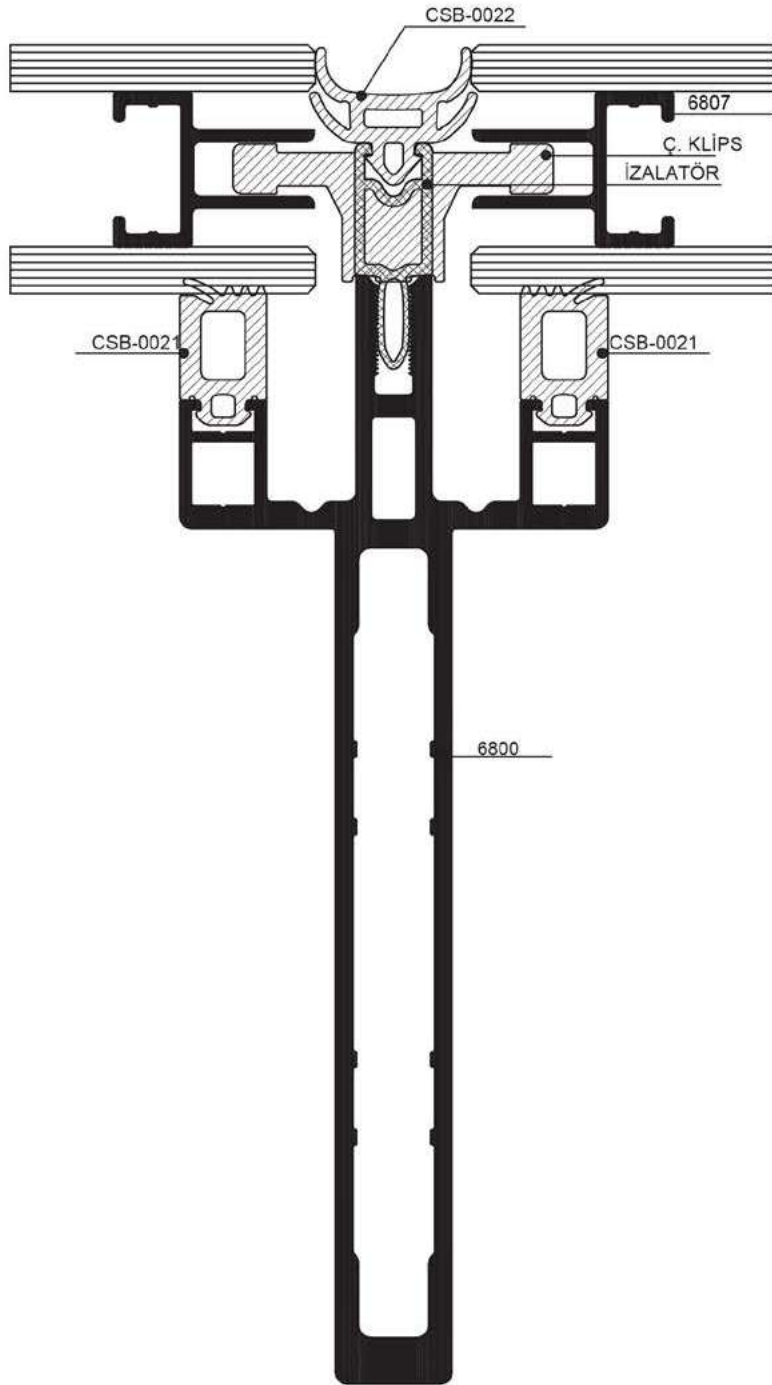
KASETSİZ SİLİKON CEPHE SİSTEM DETAYI
STRUCTURAL GLAZING SYSTEM DETAILS

KASETSİZ SİLİKON CEPHE SİSTEM DETAYI STRUCTURAL GLAZING SYSTEM DETAILS

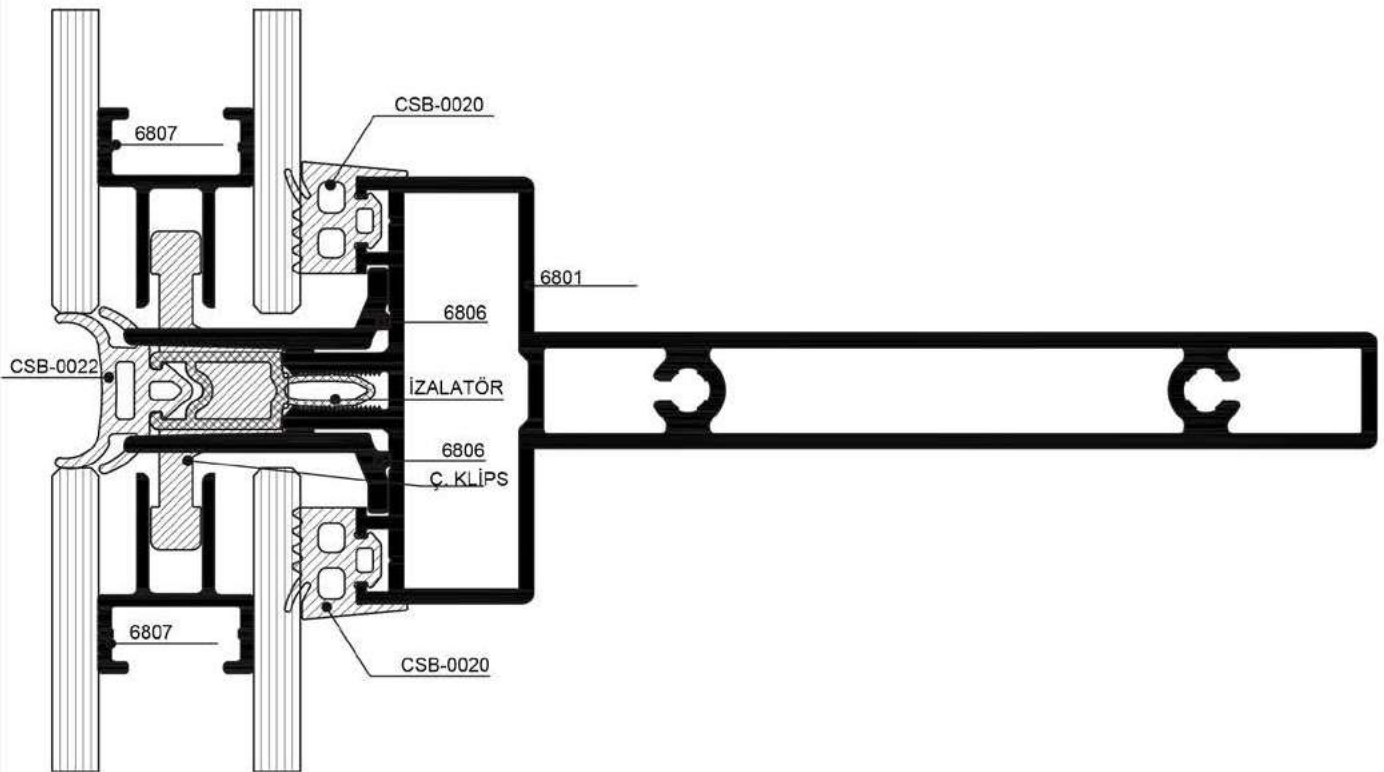
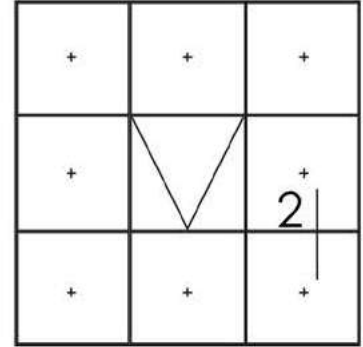

Ölçek: 1:1 / Scale: 1:1

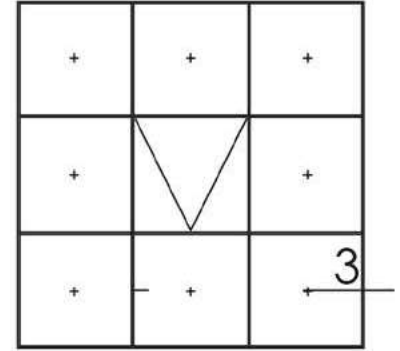
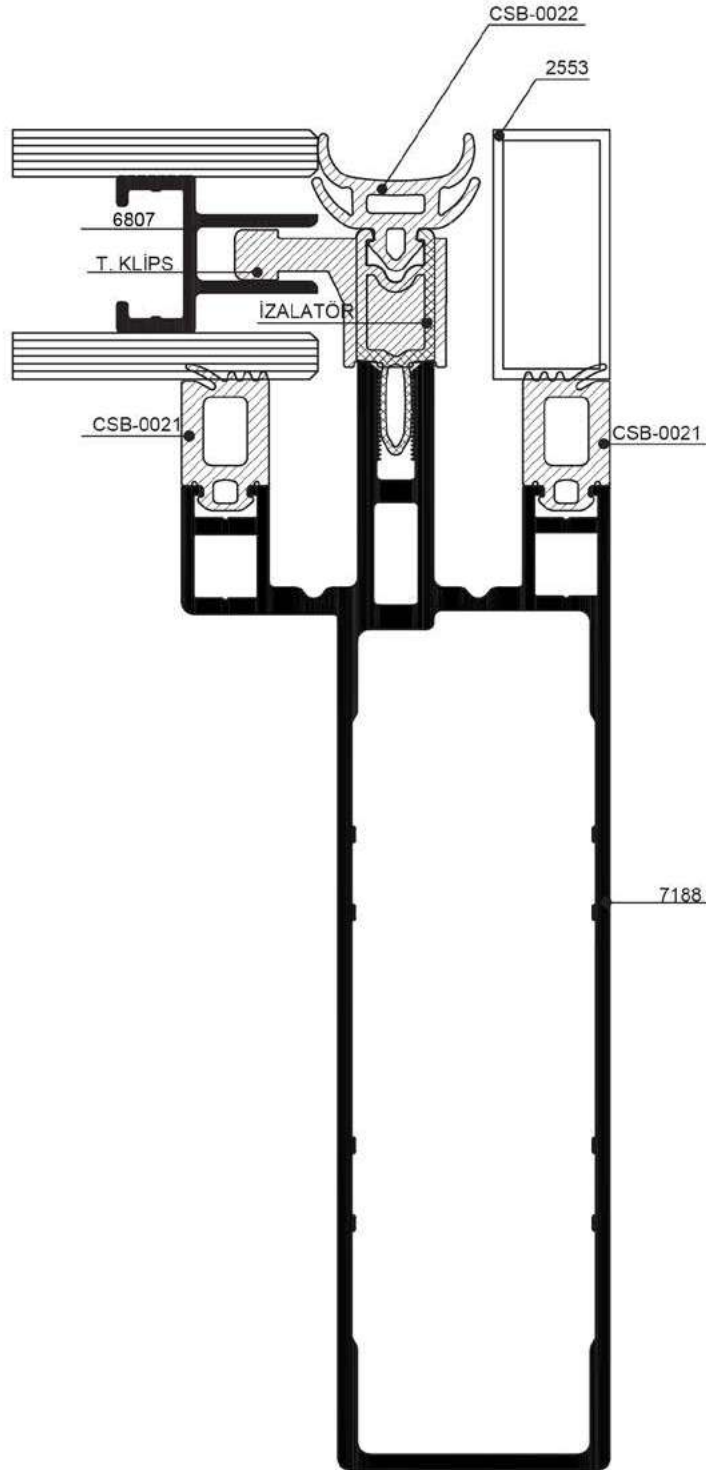
KASETSİZ SİLİKON CEPHE SİSTEM DETAYI
STRUCTURAL GLAZING SYSTEM DETAILS

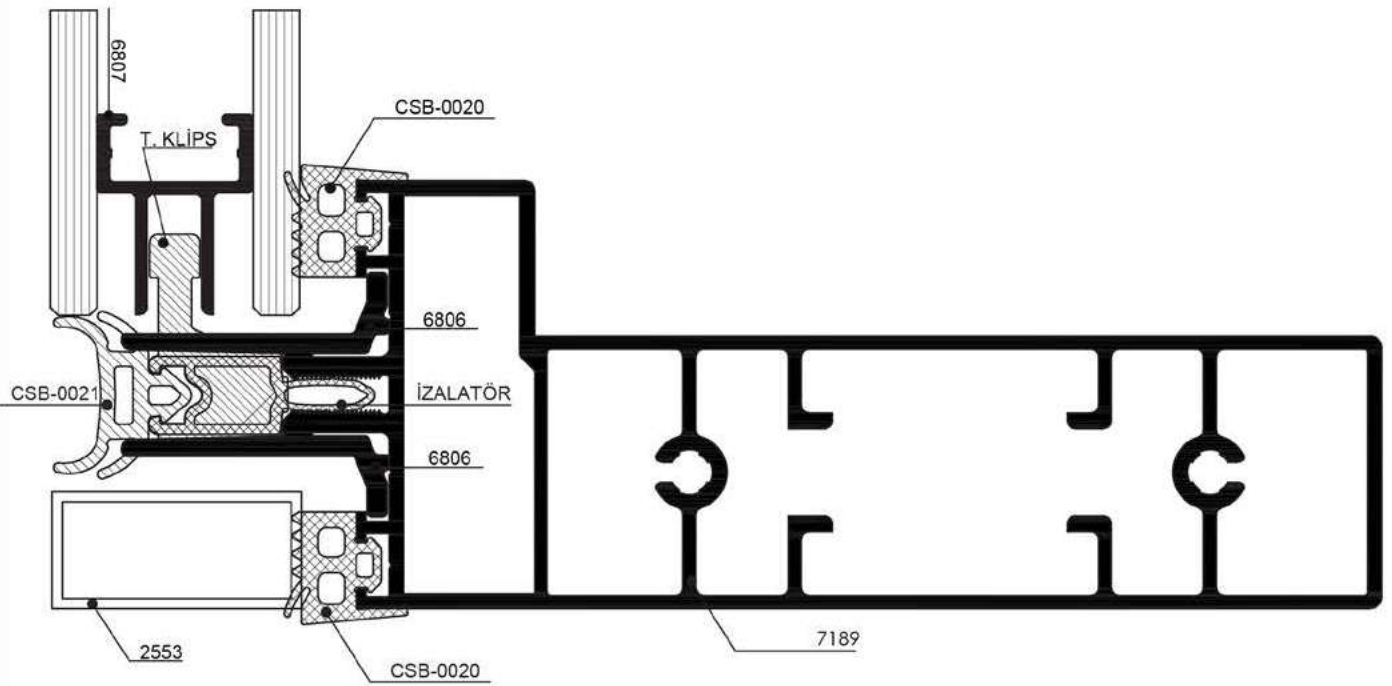
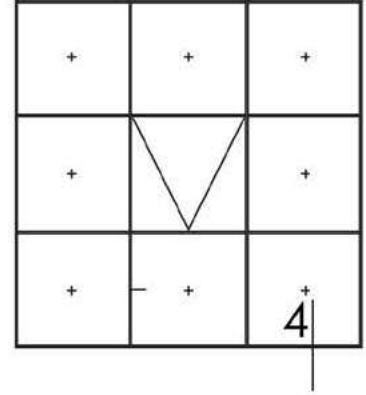
KASETSİZ SİLİKON CEPHE SİSTEM DETAYI
STRUCTURAL GLAZING SYSTEM DETAILS

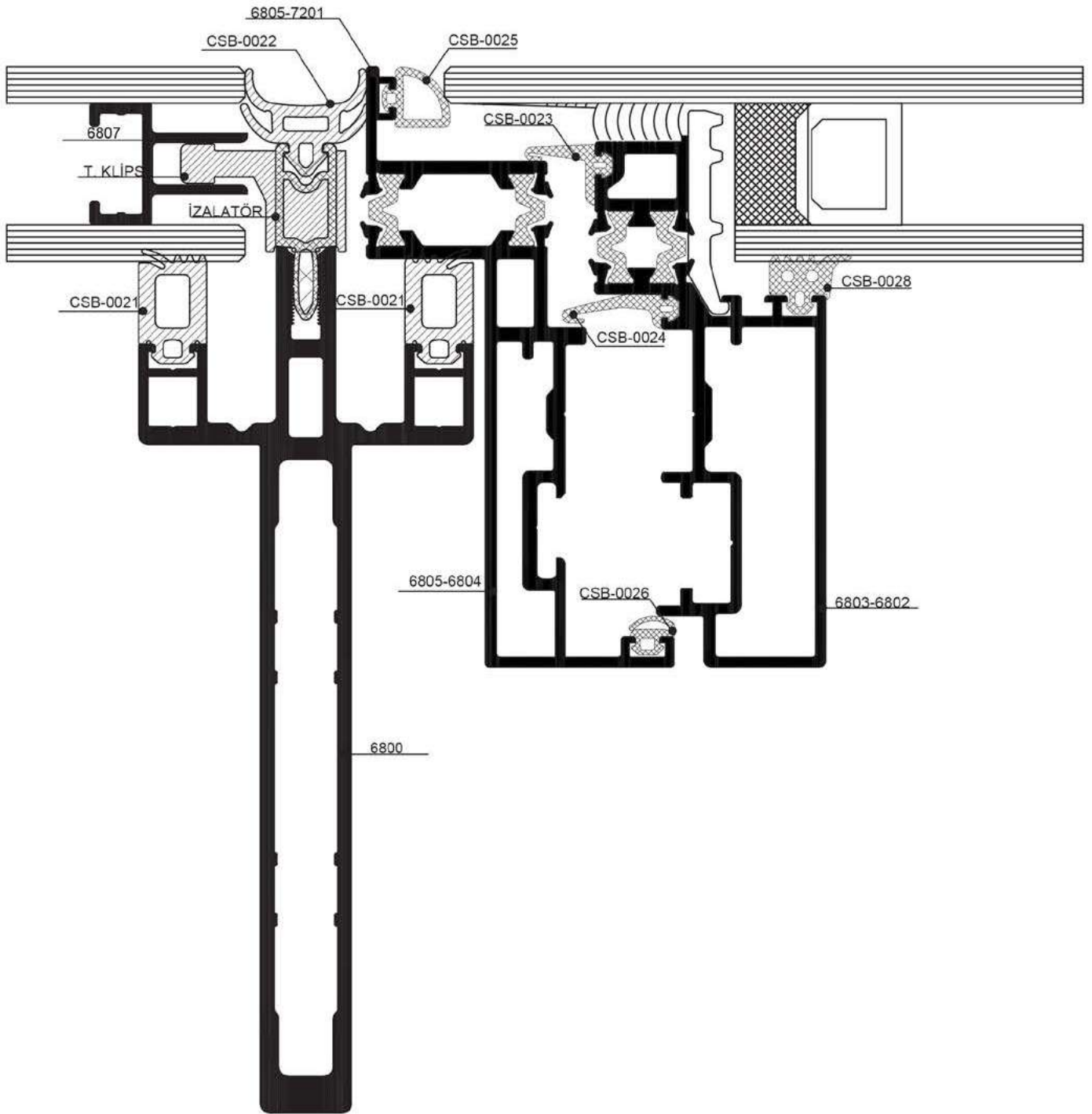
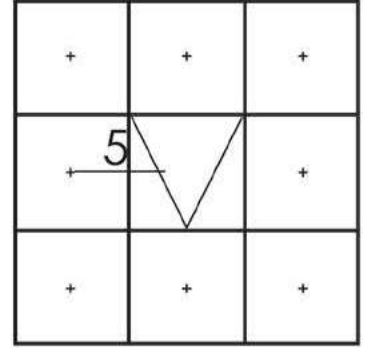
SİLİKON CEPHE SİSTEM DETAYI
STRUCTURAL GLAZING SYSTEM DETAILS

SİLİKON CEPHE SİSTEM DETAYI

STRUCTURAL GLAZING SYSTEM DETAILS

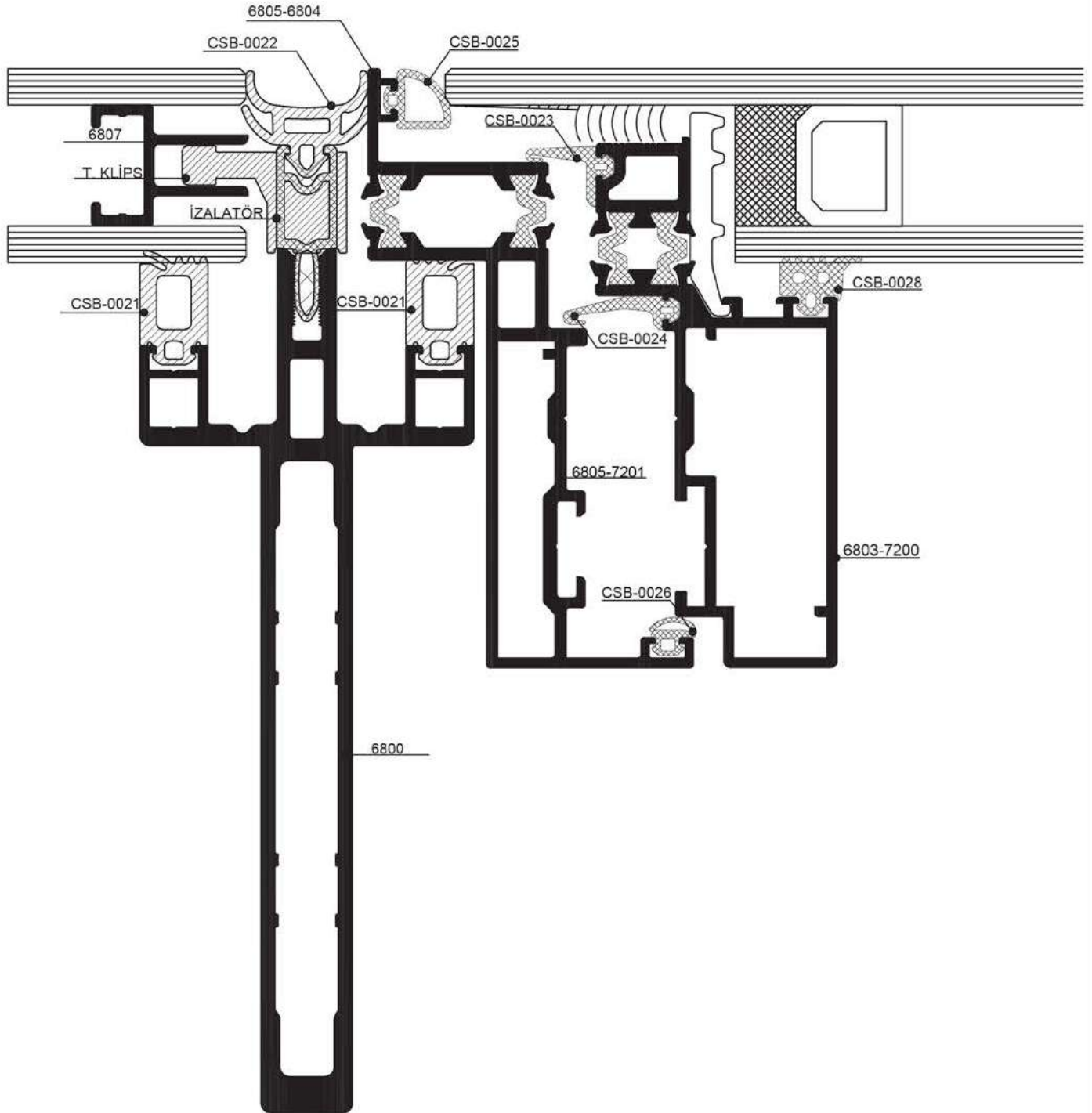
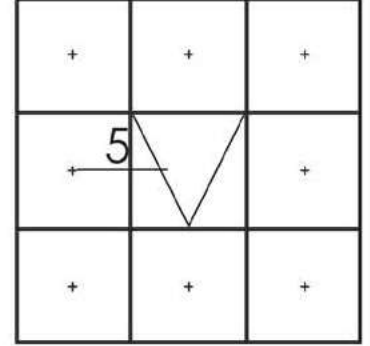

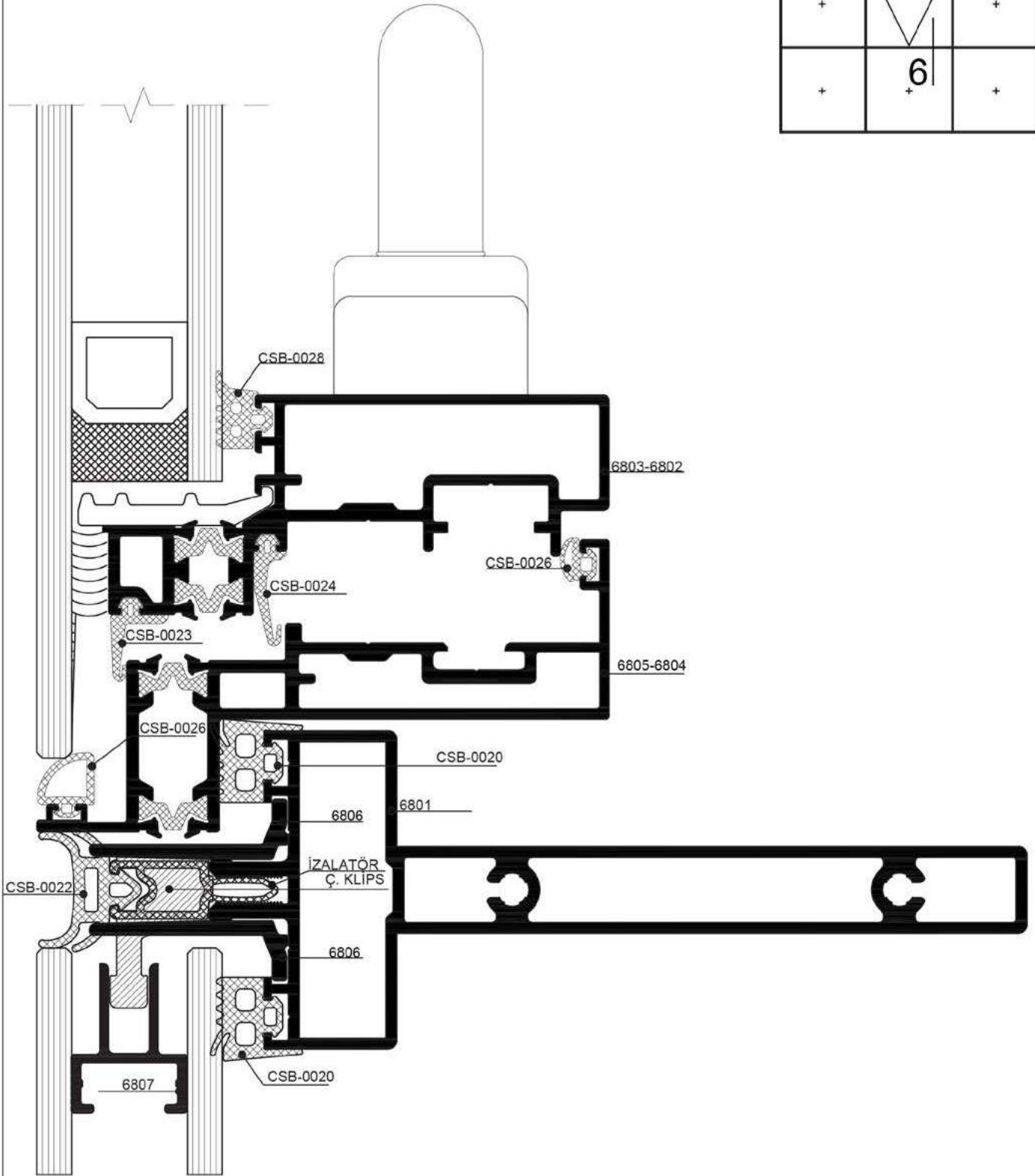
SİLİKON CEPHE SİSTEM DETAYI
STRUCTURAL GLAZING SYSTEM DETAILS

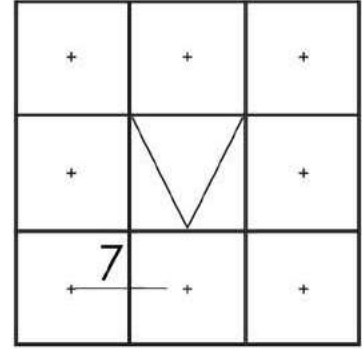
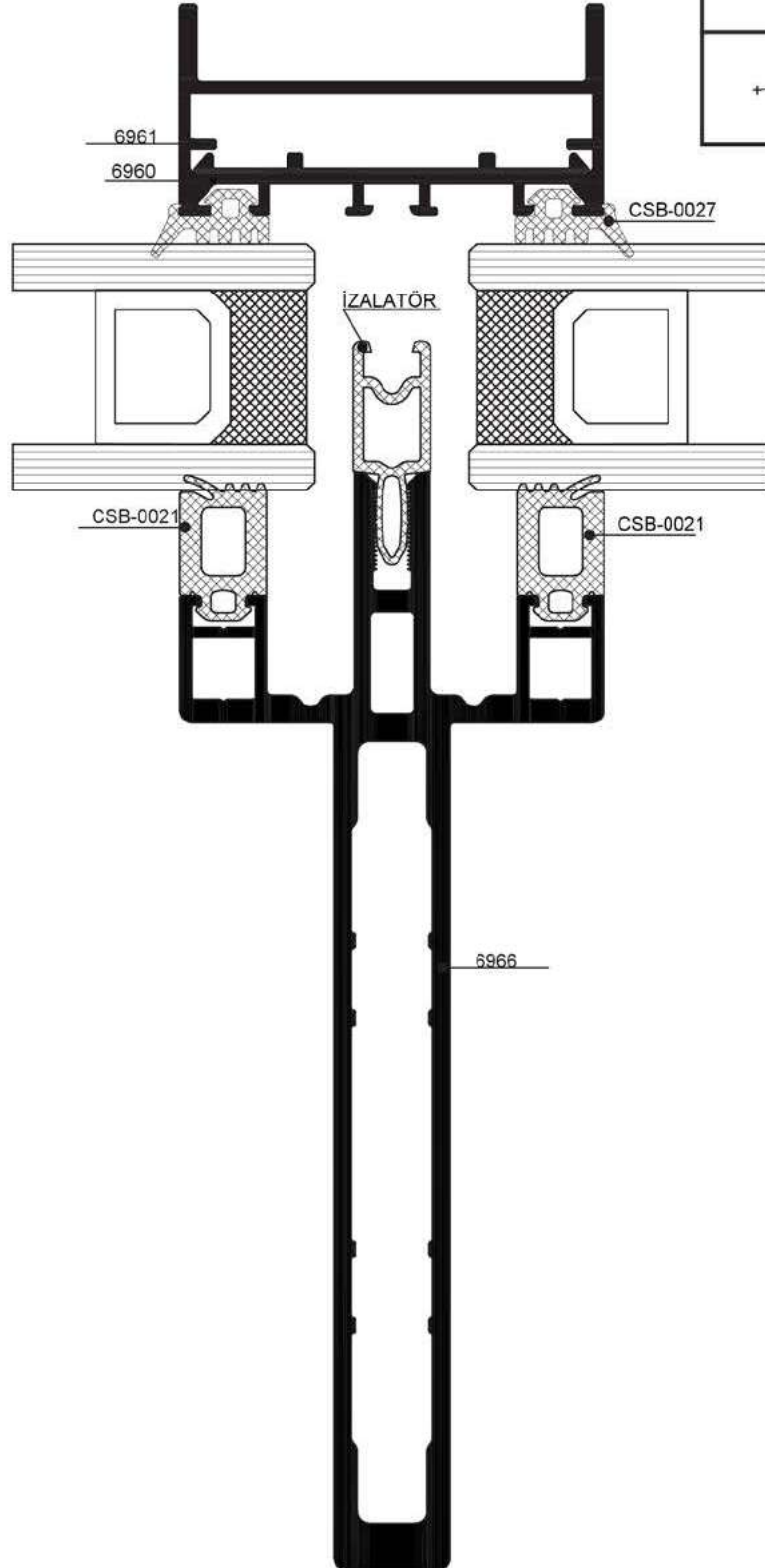
KAPAKLI CEPHE SİSTEM DETAYLARI
COVER CAP SYSTEM DETAILS

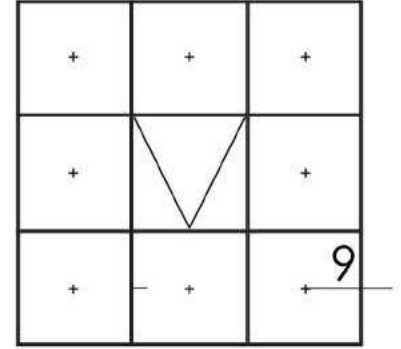
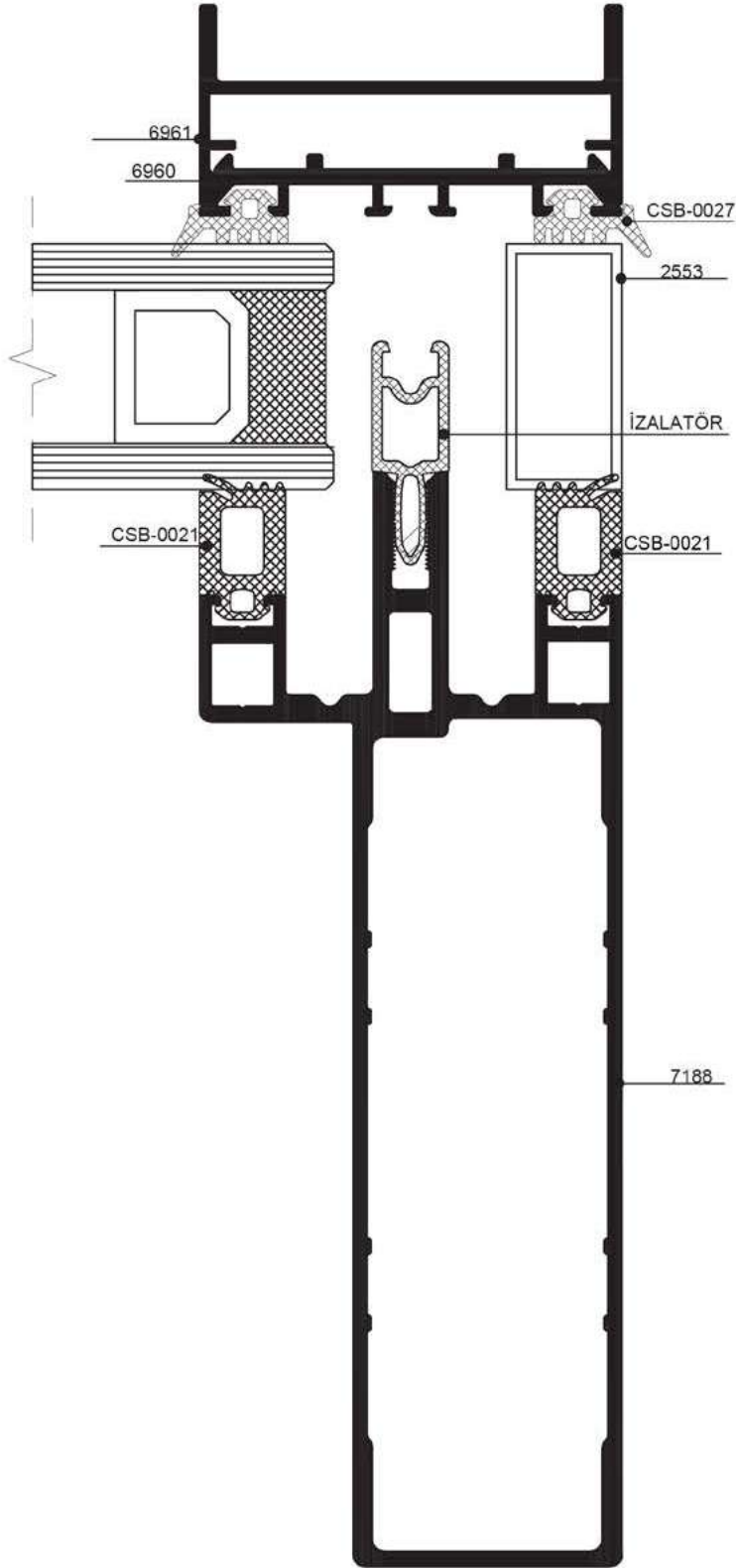
KAPAKLI CEPHE SİSTEM DETAYLARI
COVER CAP SYSTEM DETAILS

KAPAKLI CEPHE SİSTEM DETAYLARI

COVER CAP SYSTEM DETAILS

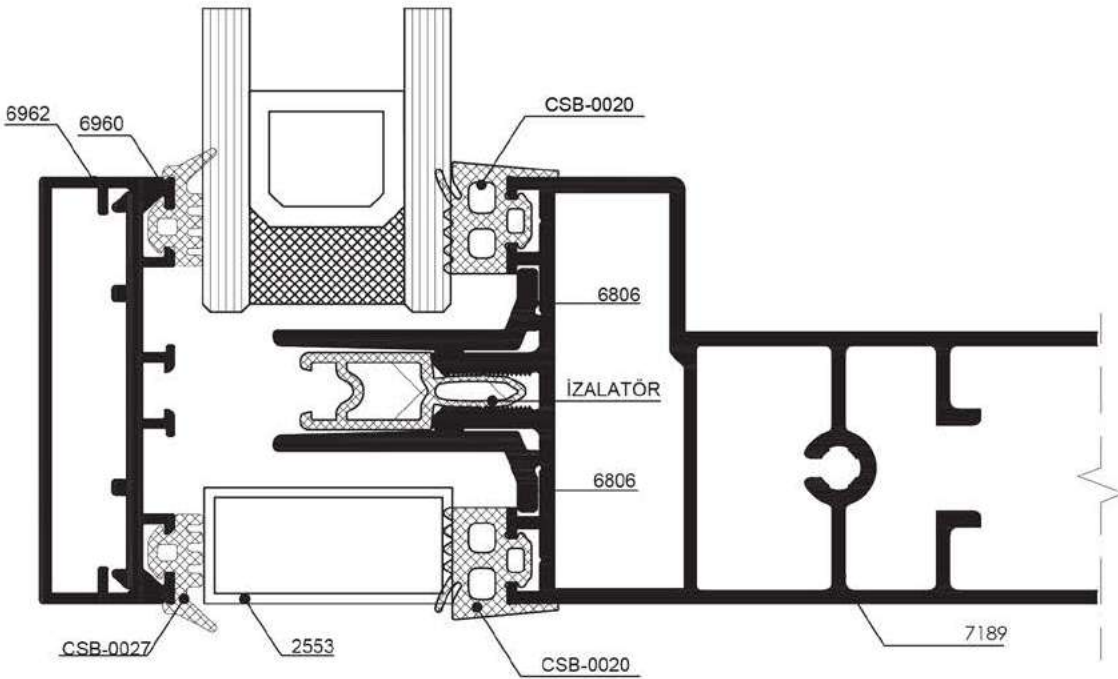
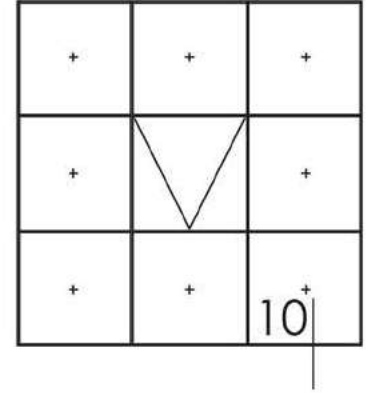

KAPAKLI CEPHE SİSTEM DETAYLARI

COVER CAP SYSTEM DETAILS

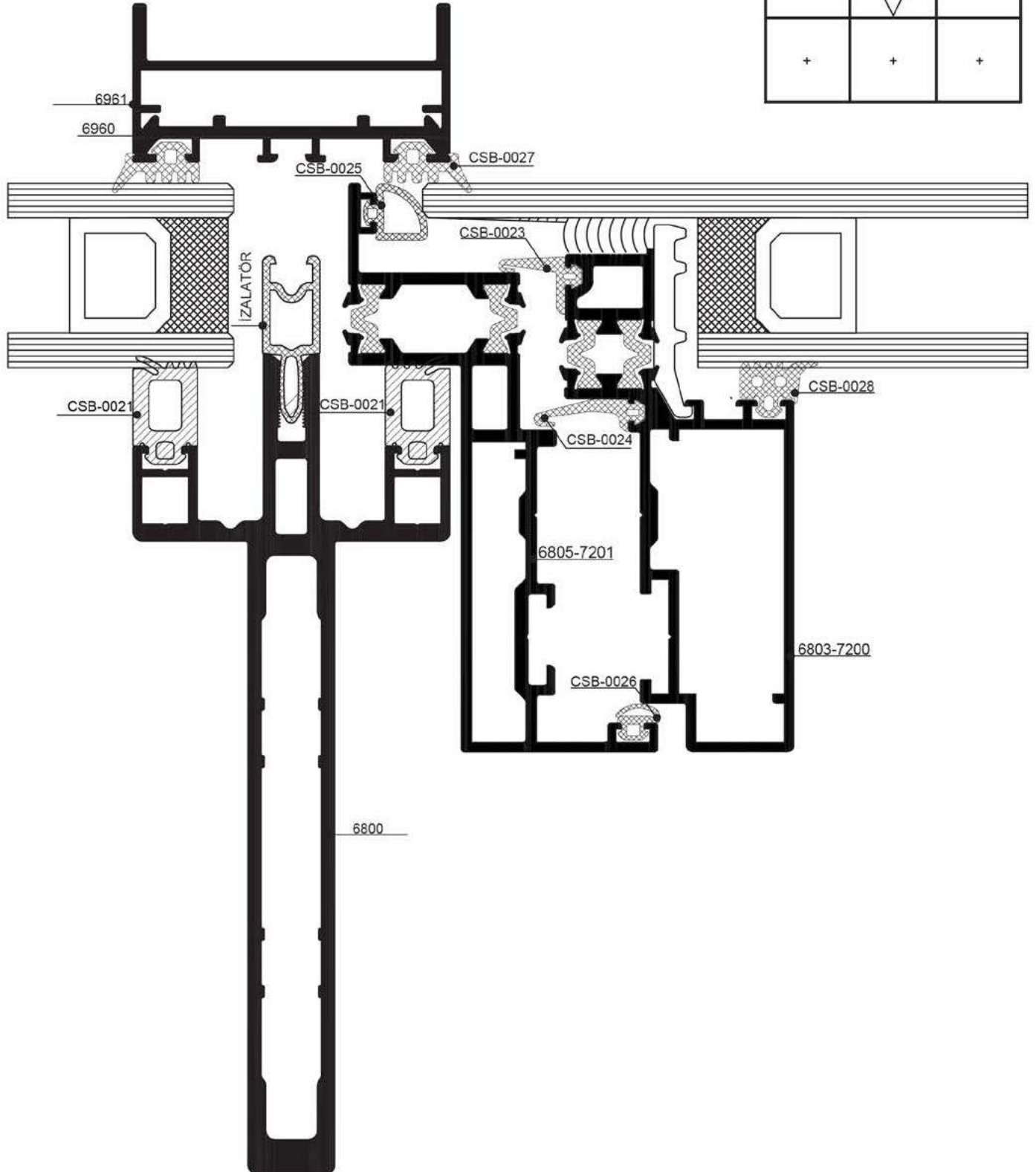

KAPAKLI CEPHE SİSTEM DETAYLARI
COVER CAP SYSTEM DETAILS



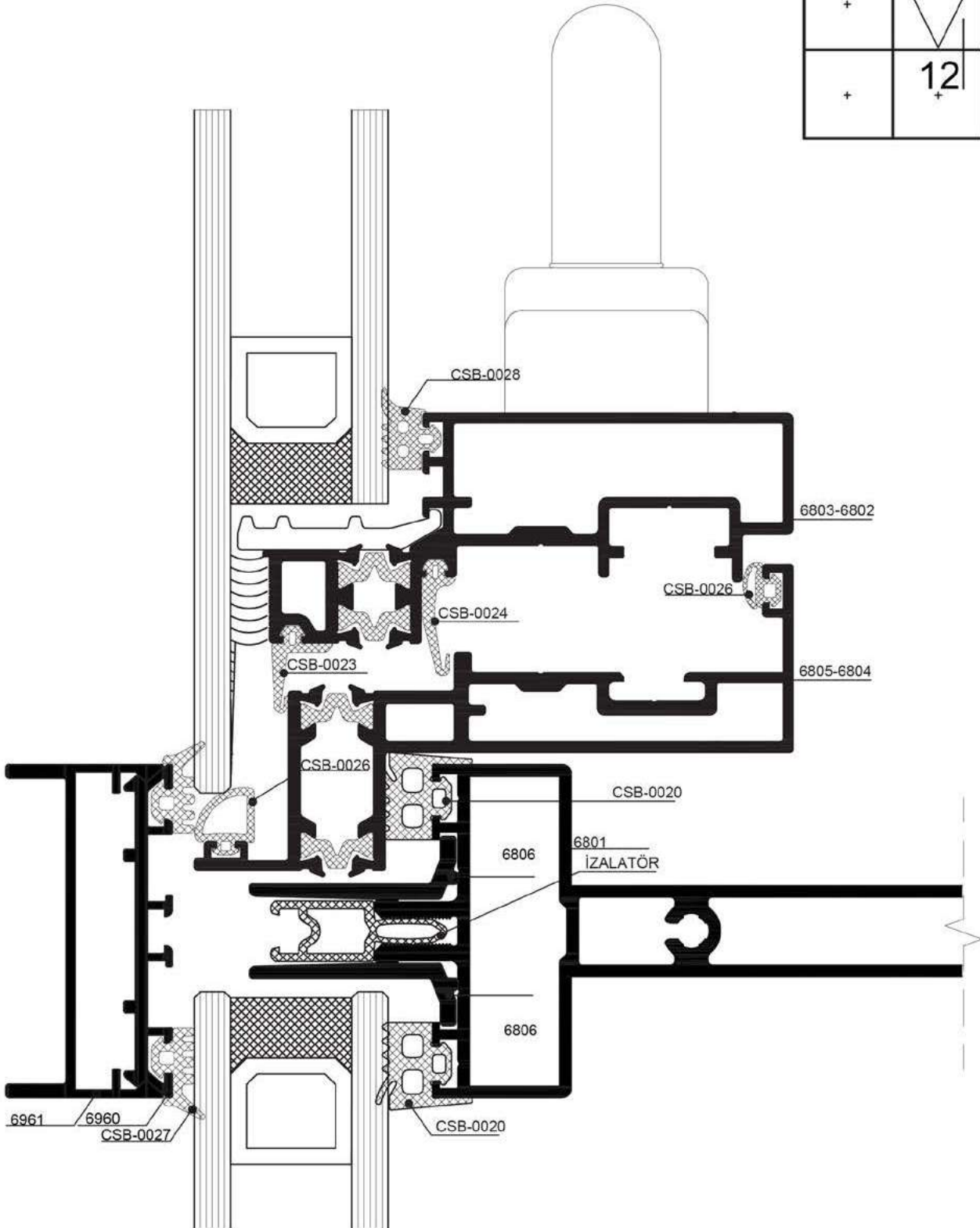





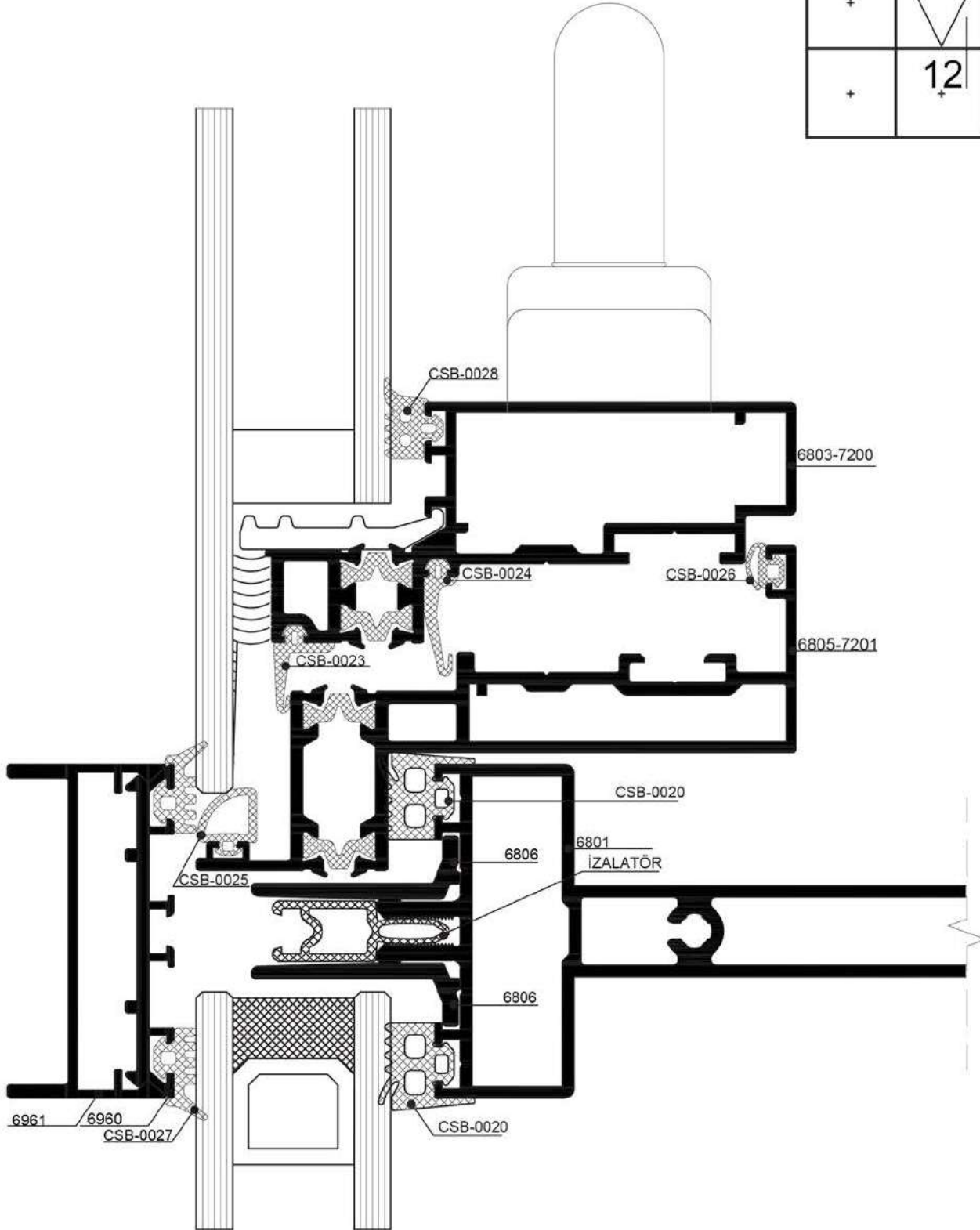

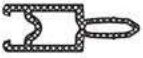
+	+	+
+	12	+
+	+	+

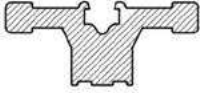

KAPAKLI CEPHE SİSTEM DETAYLARI
COVER CAP SYSTEM DETAILS

+	+	+
+	12	+
+	+	+



Ürün Çizimi Drawing	Ürün Kodu Product No	Ürün Adı Product Name	Kullanıldığı Profiller Profiles Used
	153-03-445	<i>Genleşme Yastığı</i> <i>Expansion Bearing Plate</i>	6788-6787 6785-6913 6788-6909 6785-6910 6785-6786
	153-03-446	Yatay Cephe Bağlantı Takoğu <i>Corner joint</i>	6784-6784 6780-6780
	İZALATÖR	Yatay İzalatör Horizontal Insulator	6801, 7189, 6806
	İZALATÖR	Düşey İzalatör Vertical Insulator	6800, 7188, 6803-6802, 6805-6804, 6805-7201, 6803-7200
	Ç. KLİPS	Çift Klips Double Clips	6801, 6800, 6807
	T. KLİPS	Tekli Klips Single Clips	6800, 6801, 7188, 7189, 6807
	CSB-0020	Yatay Fitol <i>Horizontal Wick</i>	6801, 7189, 6805-6804, 6805-7201
	CSB-0021	Düşey Fitol <i>Vertical Wick</i>	6800, 7188, 6805-6804, 6805-7201
	CSB-0022	Gaga Fitol Plug Wick	6800, 6801, 7189, 7188, 6805-6804, 6803-7200 Sadece Silikon Cephe
	CSB-0023	Cephe Yaprak Dış Fitili Facade Sheet Outer Wick	6803-6802, 6805-6804, 6805-7201, 6803-7200
	CSB-0024	Cephe Yaprak İç Fitil Facade Sheet Inner Wick	6803-6802, 6805-6804, 6805-7201, 6803-7200
	CSB-0025	Gizli Kasa Dış Cam Fitili Hidden Sash Outer Glass Wick	6805-6804, 6805-7201

COSABELLA®

innovative aluminum solutions

